

NOVA II

NOVA II X



NOVA II XL



OWNERS MANUAL

FOREWORD

FOREWORD

Thank you for buying the Novation Nova II keyboard Analogue Modelling Synthesiser. The module you have purchased is ideal for producing analogue style sounds which have returned to popularity in recent years. The award winning ASM (Analogue Sound Modelling) Synthesis Engine first developed by Novation for the Award winning Novation DrumStation allows the Nova II keyboard to recreate authentic analogue sounds & a lot more sounds that would not be possible on vintage analogue equipment. Whilst every effort is made to make sure the Nova II keyboard behaves in the way described in this manual, there may be differences in operation as described depending of the version of Operating System installed in the unit. Updates to the Operating System & the manual are available on the internet free. Please go to <http://www.novationuk.com> or <http://www.novationusa.com> for the latest information & Operating System for your product.

DESIGN TEAM

Chris Huggett, Ian Jannaway, Colin Jordan, Phill Macdonald (assisted by Pops) & Derek Roberts.

MANUAL

Phill Macdoanld

CONTENTS	1
FRONT PANEL	2
BACK PANEL	3
SETTING UP - BASIC SETUP	4
ADVANCED SETUP	5
ABOUT ANALOGUE SYNTHESIS	6
ABOUT FM SYNTHESIS	15
ABOUT EFFECTS	18
NOVATIONISH - NOVATION JARGON	22
ABOUT PROGRAMS	23
ABOUT DRUM MAPS	24
ABOUT PERFORMANCES	25
ABOUT FAVOURITES	27
ASSIGNING FAVOURITES	28
INSERTING A FAVOURITE INTO AN EXISTING FAVOURITES MAP	29
DELETING A FAVOURITE FROM AN EXISTING FAVOURITES MAP	30
MULTITIMBRAL USE	31
SELECTING PROGRAMS, PERFORMANCES & FAVOURITES	33
SELECTING DRUM MAPS & DRUM MAP PROGRAMS	34
EDITING & WRITING ARPEGGIATOR PATTERNS	35
EDITING & WRITING PROGRAMS	38
EDITING & WRITING PERFORMANCES	41
MASTER VOL SECTION	46
MODE SECTION	47
DISPLAY SECTION	58
KEYPAD SECTION	59
ARPEGGIATOR SECTION	61
OSCILLATOR SECTION	69
FILTER SECTION	84
LFO SECTION	91
INPUTS SECTION	95
VOCODER SECTION	98
ENVELOPES SECTION	100
EFFECTS SECTION	105
PART EDIT SECTION	120
MASTER KEYBOARD FUNCTIONS - PART EDIT SECTION	127
TROUBLESHOOTING	132
SPECIFICATION	136
BANK MESSAGES	137
MIDI CONTROLLER / NRPN TABLES	138
PROGRAM BANK A	140
PROGRAM BANK B	141
PROGRAM BANK C	142
PROGRAM BANK D	143
DRUM MAP A	144
DRUM MAP B	145
DRUM MAP C	146
DRUM MAP D	147
PERFORMANCE BANK A	148
PERFORMANCE BANK B	149
MONOPHONIC PRESET PATTERNS	150
POLYPHONIC PRESET PATTERNS	151
DISTRIBUTORS	152
INDEX	153

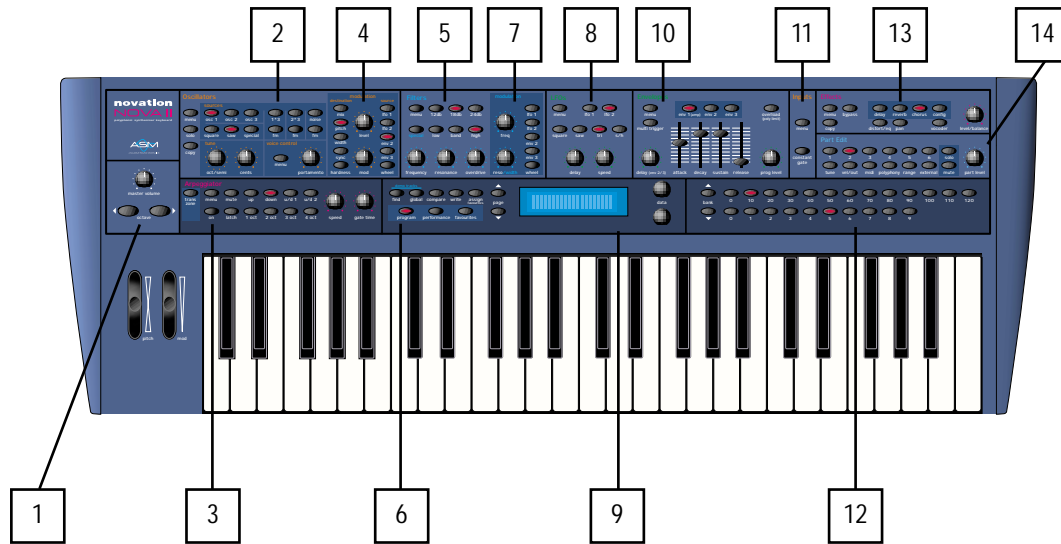

1 - Master Volume Section

This section contains the Master Volume knob & the Octave up & down buttons.

2 - Oscillator Section

This section contains all the Knobs & buttons associated with the Oscillators.

3 - Arpeggiator Section

This section contains all the Knobs & buttons associated with the Arpeggiator.

4 - Oscillator Modulation Matrix Section

This section contains all the Knobs & buttons associated with the Oscillators Modulation Matrix.

5 - Filter Section

This section contains all the Knobs & buttons associated with the Filter.

6 - Mode Section

This section contains all the buttons used to select various modes.

7 - Filter Modulation Matrix Section

This section contains all the Knobs & buttons associated with the Filter Modulation Matrix.

8 - LFO Section

This section contains all the Knobs & buttons associated with the 2 LFOs.

9 - Display Section

This section contains the Display, the Data Knobs & Page buttons.

10 - Envelopes Section

This section contains all the knobs, sliders & buttons associated with the 3 Envelopes.

11 - Input Section

This section contains all the buttons associated with the 2 Inputs.

12 - Keypad Section

This section contains all the buttons used to select sounds.

13 - Effects Section

This section contains all the knobs & buttons associated with the Effects section.

14 - Part Edit Section

This section contains all the knobs & buttons associated with Parts of a Performance.

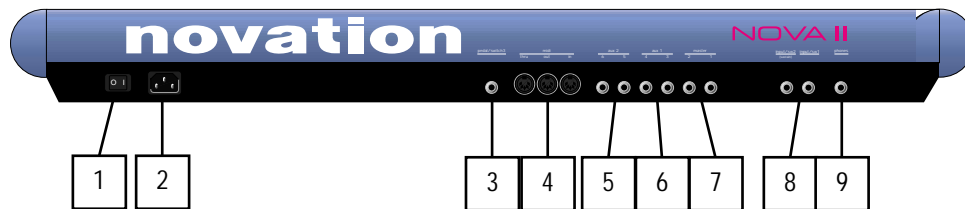

1 - Power On/Off - Switch.

This switch turns the mains power supply in the Nova II keyboard on & off. Edited & newly created Programs & Performances that have not been saved will be lost if the Nova II keyboard is switched off. Be sure to save edited Programs & Performances to memory before switching Nova II keyboard off. Refer to page 38 & 41 for details of writing Programs & Performances into memory.

2 - IEC Mains Connector.

This socket is for the supplied Mains lead. This socket accepts 110V, 220V & 240V mains supplies at 50 or 60 Hz. In other words the Nova II keyboard will work on any country's mains supply.

3 - SPDIF Phono In & Out Connectors.

These phono sockets provide SPDIF format digital inputs & outputs supplied when the optional SPDIF/ADAT card is installed.

4 - ADAT Optical In & Out Connectors.

These optical connectors provide ADAT format digital inputs & outputs supplied when the optional SPDIF/ADAT card is installed.

5 - Pedal / Switch 3 Socket.

This 1/4 inch jack socket allows the connection of either a optional footswitch or expression pedal to be connected. The function is user defined in the Global mode.

6 - MIDI IN / MIDI OUT / MIDI THRU Connectors.

The MIDI IN connector is used to receive MIDI Data from an external device.

The MIDI OUT connector is used to transmit MIDI Data to an external device.

The MIDI THRU connector re-transmits MIDI Data received by the MIDI IN socket to an external device.

7 - Master Left & Right / Aux 1 / Aux 2 & Aux 3 Audio Outputs.

The Master Left & Right 1/4 inch Jack sockets deliver a Stereo Line Level output signal for connection to a mixing desk or amplifier. The level of these outputs is controlled by the Master Volume Knob on the front panel.

The Aux 1 1/4 inch Jack sockets deliver a Stereo Line Level output signal for connection to a mixing desk or amplifier. These outputs can be used in addition with the Master Audio Outputs for more flexibility in live & studio applications.

The Aux 2 1/4 inch Jack sockets deliver a Stereo Line Level output signal for connection to a mixing desk or amplifier. These outputs can be used in addition with the Master Audio & the Aux. 1 Outputs for even more flexibility in live & studio applications.

The Aux 3 1/4 inch Jack sockets deliver a Stereo Line Level output signal for connection to a mixing desk or amplifier. These outputs can be used in addition with the Master Audio & the Aux. 1 & 2 Outputs for even more flexibility in live & studio applications.

8 - Input/SW2 & input/SW1 Connectors.

These 1/4 inch Jack sockets provide 2 audio inputs for synthesis, filtering or effect processing or as footswitch inputs. The function of these sockets is user defined in the Global mode. When used as audio inputs the sensitivity is user defined in the inputs menu.

9 - Headphones - Socket.

Use this 1/4 inch Jack Socket to monitor the Left & Right output of the Nova II keyboard via headphones. This output will drive any type of headphones. The Nova II keyboard's headphone amplifier will deliver a louder signal if low impedance headphones are used. i.e. 8 ohms impedance. Be aware that the sound pressure level obtainable with low impedance headphones could damage hearing.

SETTING UP - BASIC SETUP

Setting up

Connect the Master left & Right Audio Outputs (& the Aux. 1, Aux. 2 & Aux. 3 Audio Outputs if required) of the Nova II keyboard to a suitable amplifier or mixing desk's stereo inputs & set the Master Volume control on the Nova II keyboard to a reasonably high output level (9 - 10). This will maintain a good signal to noise ratio. Make sure the input volume on your amplifier or mixing desk is initially set to zero.

Make sure that the Nova II keyboard's mains switch is in the "OFF" position. Connect the Mains supply with the supplied lead to the Mains Socket on the Nova II keyboard. Connect the other end to the mains supply & switch the supply on. The display should now illuminate showing the Performance, Program or Favourite that was selected the last time global data was written into memory. Refer to page 48 for details on this function. Now switch on your amplifier & adjust the volume accordingly whilst playing the keyboard.

The keyboard will be playing the currently selected Performance, Program or Favourite. To listen to all of the Factory sounds, make sure you are in the Performance, Program or Favourite Mode by pressing the Performance, Program or Favourite Button & use the Keypad section to call up the different sounds. For details on how to select the different Performances & Programs & what they are refer to page 33.

Basic setup

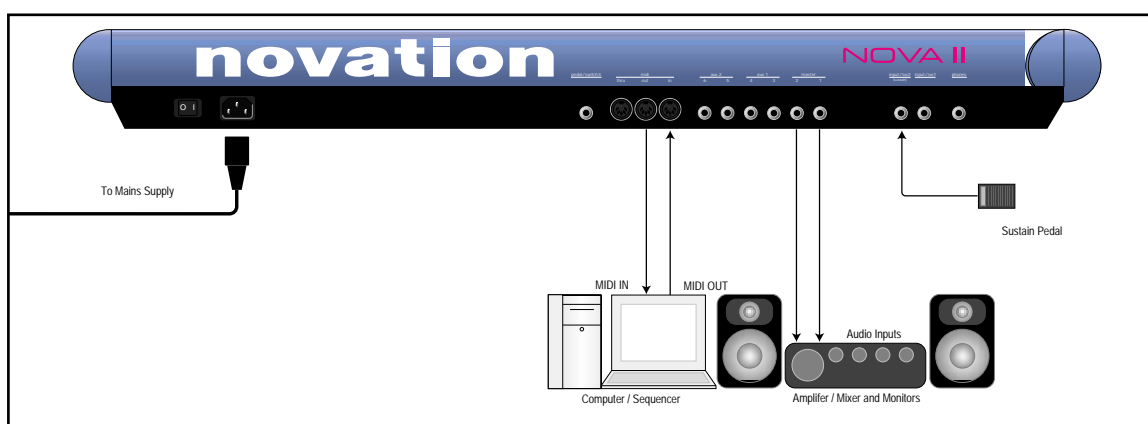

Above is a diagram of the basic way to set-up the Nova II keyboard. Normally the set-up would be as follows: Connect the Nova II keyboard as shown above. Set the "Local On/Off" parameter on page 7 of the Global mode to OFF. Turn the Computer Software / Sequencer's "Soft Thru" (or sometimes called "Echo Back") to the "ON" or "Enabled" position. Now when selecting a "Track" in the computer Software / Sequencer that is assigned to the same channel as the Nova II keyboard is set to receive on (If this is a Performance you can set the receive channels individually for each "Part". Refer to page 123 for details, If this is a Program, Programs are played on the "Global MIDI Channel. Refer to page 48 for details.) playing the keyboard should produce sounds through the Headphones / Monitors.

The Nova II keyboard can have virtually any parameter controlled via MIDI. The movement of any knob, the pressing of any button or change to any parameter can be recorded with this setup. These recordings can then be easily edited on a sequencer. Details on all the controllers & NRPNs used by the Nova II keyboard can be found on page 138 to page 139.



NOTE:

If there are additional keyboards / Modules connected via MIDI, this diagram does not include audio for the keyboards / Modules. The audio outputs of these devices must also be connected to the mixer.

To listen to the Factory Demo

Once the Nova II keyboard is connected as shown you can listen to the Factory Demonstration. To do this press the Find & Global buttons at the same time.

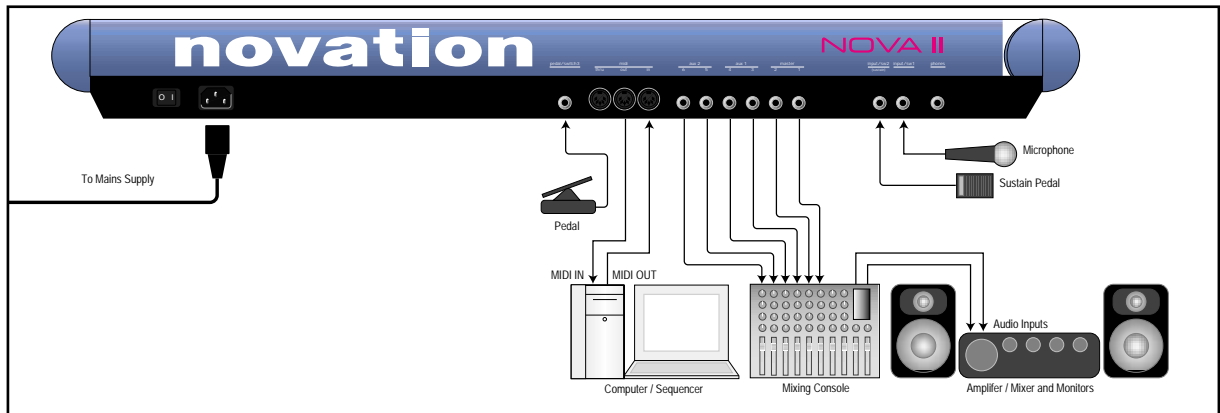

This is the one of the more advanced ways to set up the Nova II keyboard. Connect the Nova II keyboard as shown above. Set the "Local On/Off" parameter on page 7 of the Global mode to OFF. Turn the Computer Software / Sequencer's "Soft Thru" (or sometimes called "Echo Back") to the "ON" or "Enabled" position. Now when selecting a "Track" in the computer Software / Sequencer that is assigned to the same channel as the Nova II keyboard is set to receive on (If this is a Performance you can set the receive channels individually for each "Part". Refer to page 123 for details, If this is a Program, Programs are played on the "Global MIDI Channel. Refer to page 48 for details.) playing the keyboard should produce sounds through the Headphones / Monitors.

The Nova II keyboard can have virtually any parameter controlled via MIDI. The movement of any knob, the pressing of any button or change to any parameter can be recorded with this setup. These recordings can then be easily edited on a sequencer. Details on all the controllers & NRPNs used by the Nova II keyboard can be found on page 138 to page 139.

There are 4 stereo pairs of Outputs connected to the mixer. This allows individual sounds to be processed externally by the mixer & other outboard equipment. To direct "Parts" of a "Performance" to these separate outputs Refer to page 122 for details. Additionally, the Nova II keyboard automatically redirects the effects outputs for the selected part to go to the same outputs as the part, so even if separate outputs are assigned the associated effects follow automatically.

Additionally a microphone is connected to Input/SW1 & this allows external signals to be processed by the synthesis engine (including filtering) and/or effects processors & Vocoder of the Nova II keyboard. In fact virtually any type of signal can be used by the Nova II keyboard, as the gain of the 2 inputs can be adjusted from Microphone level through to Studio levels. (+4dBm) Refer to page 95 for details on how to use the inputs. The inputs can also double as Footswitch inputs & a footswitch is connected to Input/SW2. The function of this can be user determined in the Global mode. Refer to page 52 for details.

An expression pedal input is also provided allowing a optional pedal to be connected. This allows the volume of the keyboard to be controlled from the expression pedal. This to can be a footswitch input. The function of this Pedal/Switch input can be user determined in the Global mode. Refer to page 53 for details.

ABOUT ANALOGUE SYNTHESIS

OSCILLATORS - *pitch*

To understand synthesis, it is necessary to have some understanding about sound itself. Sound is a vibration or oscillation. These vibrations create changes in air pressure which is picked up by your ears & is perceived as sound. When dealing with musical sounds the vibrations or oscillations occur at regular intervals & are perceived as the "Pitch" or "Frequency" of a sound. The simplest musical sound is a sine wave because it contains only one "Pitch" & is perceived as a very "Pure" tone similar to a whistle. Most musical sounds consist of several different "Pitches" or "Frequencies". The loudest is referred to as the "Fundamental" & determines the perceived "Pitch" of the note. The other frequencies present are called "Harmonics" & in musical sounds usually occur in multiples of the fundamental frequency. i.e. if the fundamental note is 440Hz then a musical harmonic series would be 2nd harmonic = 880Hz, 3rd harmonic = 1320Hz, 4th harmonic = 1760Hz, 5th harmonic = 2200Hz etc. The number & loudness of these "Harmonics" determines the "Timbre" of a sound. This gives a sound character & is why a violin sounds different from a guitar & a piano sounds different again. In an Analogue synthesiser, you have the choice of several different waveforms. Each waveform has different amounts of harmonics & so the "Timbre" of each one is quite different. Below are descriptions of some of the waveforms & indications on what they can be best used for.

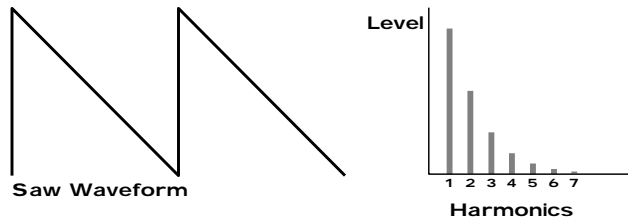

Sawtooth waves have all the harmonics of the fundamental frequency. As you can see, every harmonic has half the amplitude of the previous one. This sound is pleasing to the ear & is useful for basses, leads, & synthesising stringed instruments.

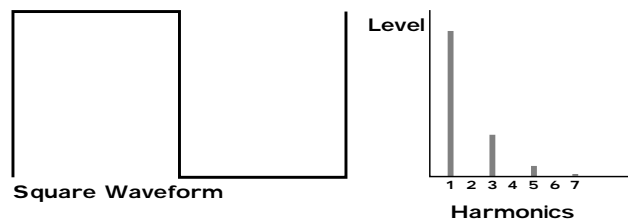

Square waves have only the odd harmonics present. These are at the same amplitudes as the odd harmonics in a saw wave. Square waves have a hollow / metallic sound to them & so are useful in creating unusual synthesiser sounds & oboe like sounds.

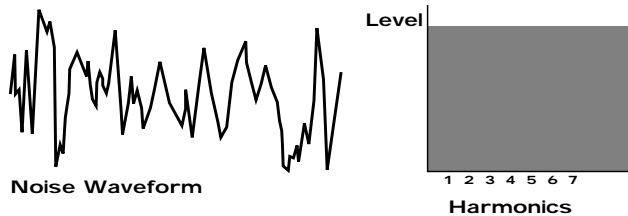

White noise has no fundamental & all harmonics are the same value. This wave can be used by itself to synthesise explosions or wind & when used in conjunction with other waveforms can be used to create the illusion of "Breath" in an instrument.

PWM (PULSE WIDTH MODULATION)

The choice of waveform is important as it determines the basic "Timbre" of the sound you are making. There are additional methods of synthesis that allow more harmonics to be generated. The First of these is Pulse Width Modulation. (PWM for short). Essentially the duty cycle of the normally symmetrical square wave is varied. This means the wave form goes from a Square wave to a Pulse wave like so:



This has a very pleasant "thickening" chorus like effect & is often used in Pad type & String section type sounds.

Additionally there is a synthesis method called Oscillator sync. This takes two oscillators & uses one (the Master) to reset the

other (The Slave) each time it starts a new cycle. The effect is most noticeable when the two oscillators are out of tune as shown below.

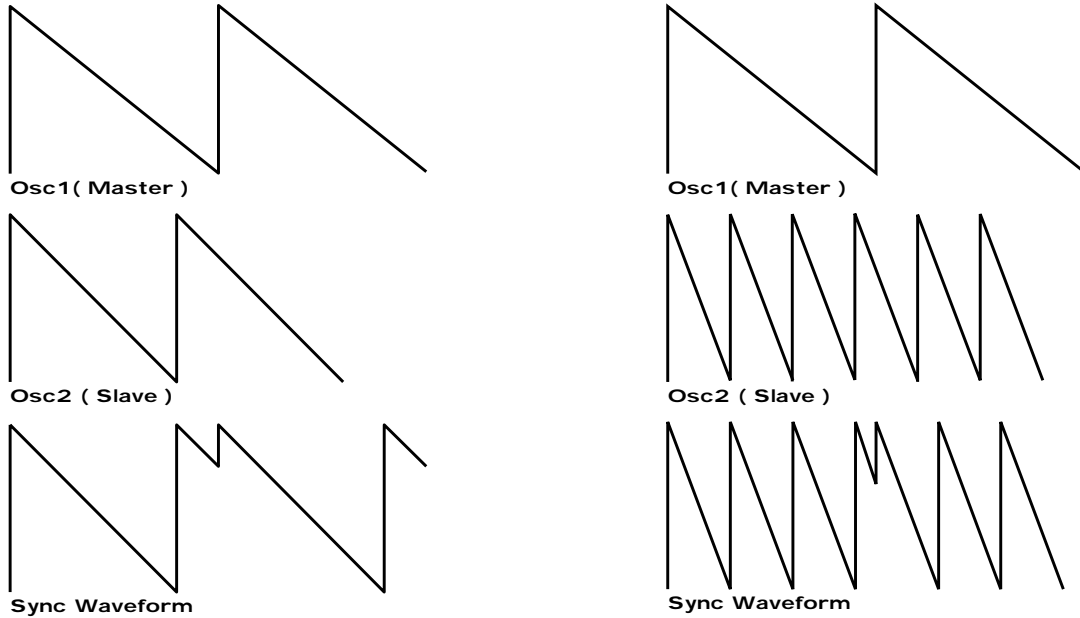

This Sync Effect creates very piercing & metallic sounds & are used a lot as lead sounds. It is worth noting that the Nova II keyboard does not require 2 oscillators to create this effect. The Sync "Effect" is created by the Analogue Sound Modelling process without the need for a Sync Oscillator, there is merely a "Sync" parameter that creates the classic Sync Effect. This means that each of the 3 oscillators in one Nova II keyboard "voice" can be independently Sync'ed as if there were 3 Master & 3 Slave oscillators.

Analogue Sound Modelling technology also enables the creation of some new "Sync" related parameters that are not found on analogue synthesisers. These are "Key Sync", "Sync Skew" & "Formant Width"

Normally on an analogue synthesiser, even though the Master & Slave oscillators are detuned relative to each other, they both track keyboard pitch equally. i.e. if you play notes one octave apart, both the Master & the Slave oscillator will be transposed one octave. "Key Sync" allows the slave oscillator to have its pitch tracking adjusted independently. This means that the "Sync Effect" will change as you play different notes up & down the keyboard.

Sync Skew manipulates the frequency of the "virtual" slave oscillator within one cycle of the master oscillator. The result is that the Sync Effect seems to have a higher frequency at the end of each cycle with positive modulation & at the start of the cycle with negative modulation. This parameter makes the sync waveform sound even harsher. This is particularly good for aggressive lead sounds.

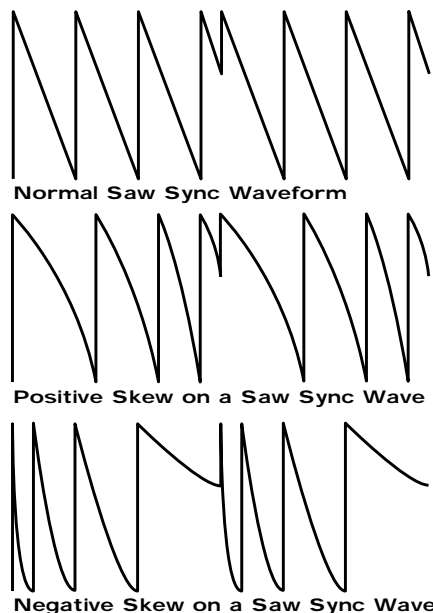

ABOUT ANALOGUE SYNTHESIS

Sync Skew also effects the standard Square & Saw waveforms. The effect is to “swash” the waveform at the end of its cycle with positive modulation & swashing the waveform at the beginning of the cycle. On a square wave, moderate amounts of this effect produce similar effects to Pulse width modulation except width modulation over 100% can be achieved allowing many cycles to be “swashed” into one original one. This can also be described as Frequency Modulation within the cycle & so mimics classic “Cross Modulation” with a Saw wave. This can produce effects similar to Sync but when this parameter is used in conjunction with Formant Width the results can be very different. Below are examples of Sync Skew on standard Square & Saw waveforms. Note how the wave is swashed at one end & more than one cycle has been swashed into the original cycle.

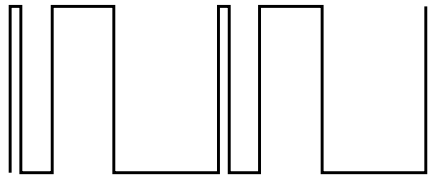

Negative Skew on a Square Wave

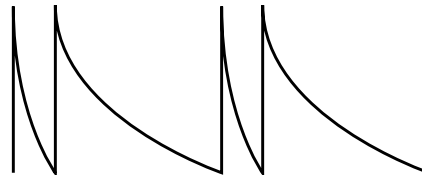

Negative Skew on a Saw Wave

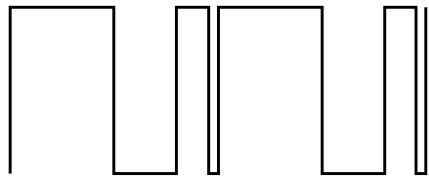

Positive Skew on a Square Wave

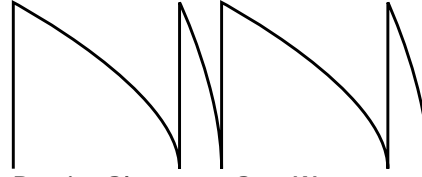

Positive Skew on a Saw Wave

Formant width is a parameter that controls the level of the cycles of the “virtual” slave oscillator. This can be used to simulate resonance within the oscillator itself by using the “Harden” parameter to smooth out the sharp edges of this wave form. The effect is to reduce the level of every successive slave cycle. Additionally this parameter has an effect on the normal Saw & Square waveforms. The effect is to boost the treble content of these waves.



Sync Waveform

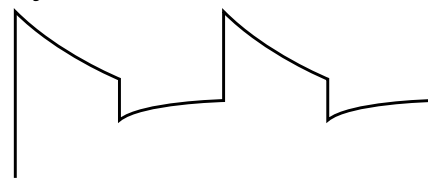

Formant Width on a Square Wave



Sync Formant Width Waveform

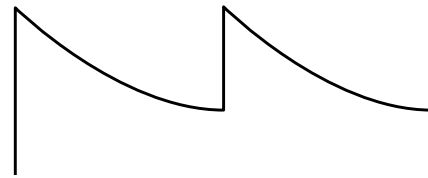

Formant Width on a Saw Wave

Both Sync Skew & Formant Width can be used in conjunction to create yet even more waveforms. Below are examples.



Negative Skew & Formant Width on a Saw Wave

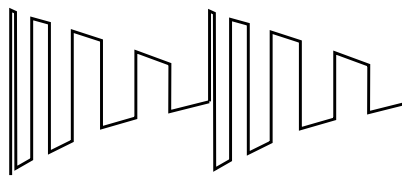

Negative Skew & Formant Width on a Square Wave

Analogue Sound Modelling technology allows even more control over the waveform. Once you have selected your basic oscillator waveforms you can further modify them using a “Hardening” process. This “Hardening” rounds off all the “Sharp” edges of the waveform, thereby reducing its harmonic content. Below is an example of the “Harden” parameter on a Square wave.

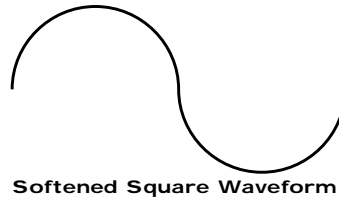
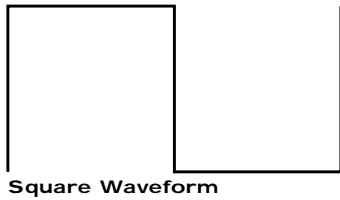

The Harden parameter is completely variable & can reduce a square wave to only one harmonic producing a Sine wave. The Harden process can also be applied to the noise generator providing control over the harmonic content of the noise. Below is an example of the "Harden" parameter on Pink Noise.

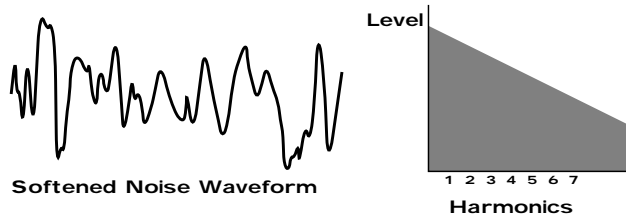
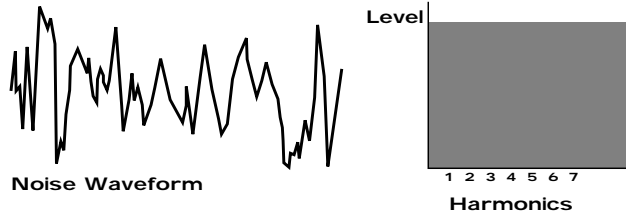

Finally there is Ring modulation. This uses two oscillators but instead of adding them together like in a mixer they are multiplied together. This is very similar to FM & produces the kind of effect shown below:

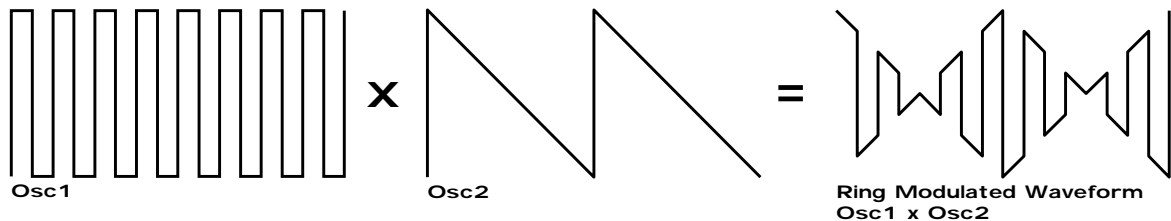

The Ring Modulation effect creates metallic & bell like sounds & is used generally for lead sounds, but if used subtly can produce Electric Pianos etc & if used radically can produce unusual sound effects.

All these methods further enhance the basic Oscillator waveforms to include many more or a useful mix of harmonics. Once the waveforms have been selected you can then "fine tune" the harmonic content of the mixture of different waveforms by passing them through a "Filter" to remove unwanted harmonics. The filter in an Analogue synthesiser is a very powerful "Tone Control". Like the tone control on a stereo, the filter can alter how things sound but it cannot change the style of music being played on the record, & so the filter in a synthesiser can alter the "tone" of a sound but is restricted by the basic "Timbre" of the waveforms. For this reason, several waveforms are available at once & you can "Mix" them together to provide more harmonically rich waveforms. Below is a diagram showing the signal path in the Nova II keyboard & all the waveforms at various locations.

ABOUT ANALOGUE SYNTHESIS

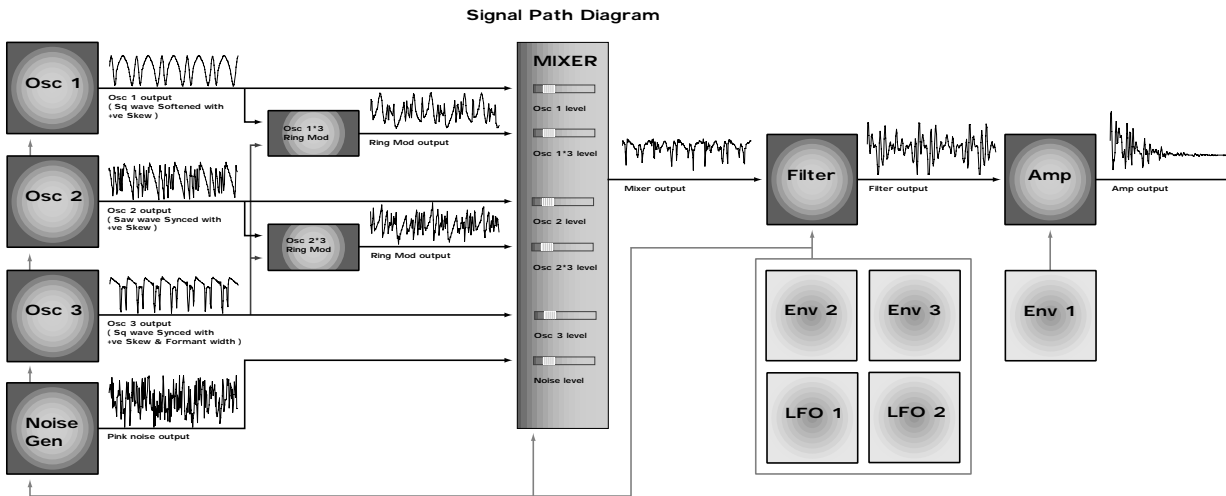

Different waveforms are being produced by different oscillators using different techniques. The Oscillators, Ring Modulators & the Noise Generator all being Mixed together & feed to the filter. The signal is then in turn fed to the Amplifier. Oscillator 1 is using a Square wave modulated by Sync Skew & then Hardened to create a sine-like wave except it has an extra bump in it. This produces a Whistle like sound. Oscillator 2 is using a Saw wave modulated by Sync Skew & Sync producing a Harsh sound & Oscillator 3 is using a Square wave modulated by Sync Skew & Formant Width to produce a bright PWM like waveform. The 1*3 Ring modulator & the 2*3 Ring modulator are producing complex waveforms & these along with all the Oscillators & the Noise generator are fed to the Mixer.

FILTER - tone

There are several different types of filter. These are Low Pass Filter, High Pass Filter & Band Pass Filter. The Low Pass Filter allows harmonics below a set frequency to pass through the filter. Hence the name Low Pass Filter. The High Pass Filter allows harmonics above a set frequency to pass through the filter. Hence the name High Pass Filter. The Band Pass Filter allows harmonics at a set frequency to pass through the filter, the harmonics above & below the set frequency do not pass through the filter. Hence the name Band Pass Filter. Below are the frequency response curves of the three types of filters.

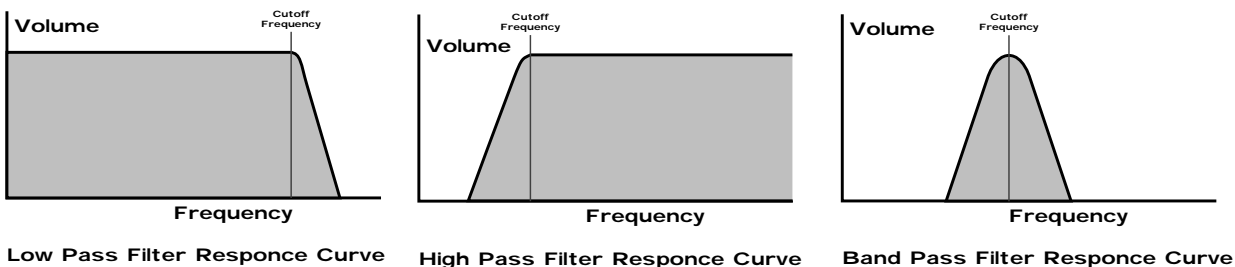

Additionally the slope of the curve at which the filter rejects unwanted harmonics can be altered. The effect is similar to a "Q" control on a parametric EQ. In the 12db position the Cutoff Frequency slope is less steep so the higher frequencies are not attenuated as much as they are in the 24 or 18db positions. This makes the resulting filtering in the 12db position more subtle than the 24 or 18db positions which you should select if you want the Cutoff Frequency to be more obvious. The slope is measured in db per Octave & below are the response curves of a Low Pass Filter with 24, 18 & 12 db per Octave slopes.

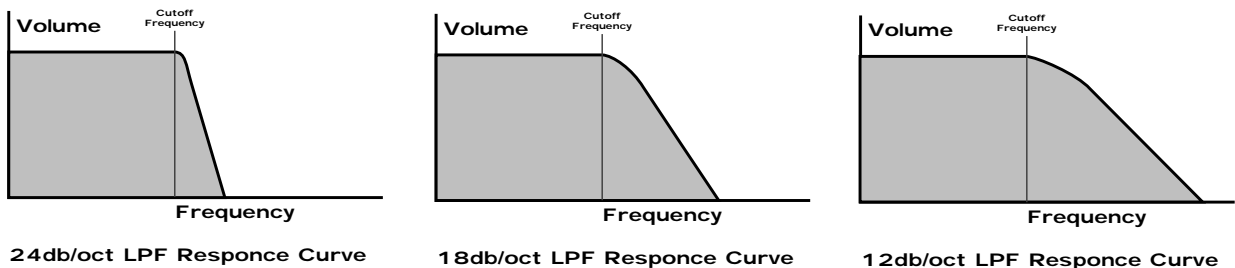

All these filters have a Resonance parameter. This has the effect of emphasising harmonics at the cutoff frequency of the filter. This is very useful for creating large tonal differences to a basic waveform. The effect is shown below as both frequency response curves when resonance is applied in a the Filter.

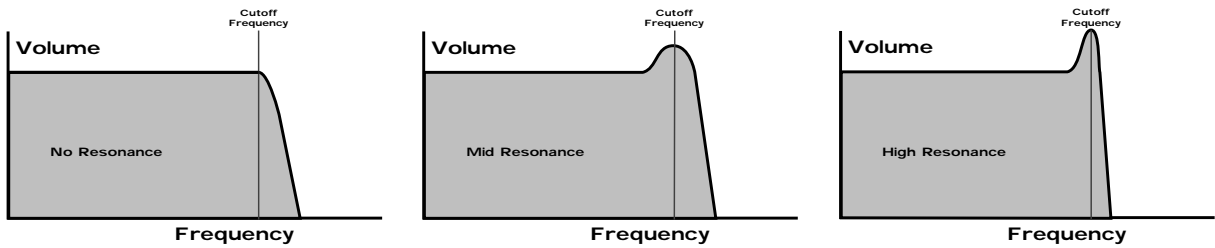

Low Pass Filter with Resonance Response Curves

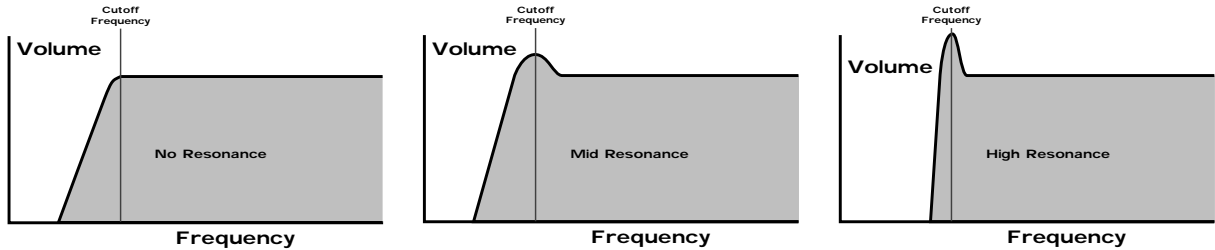

High Pass Filter with Resonance Response Curves

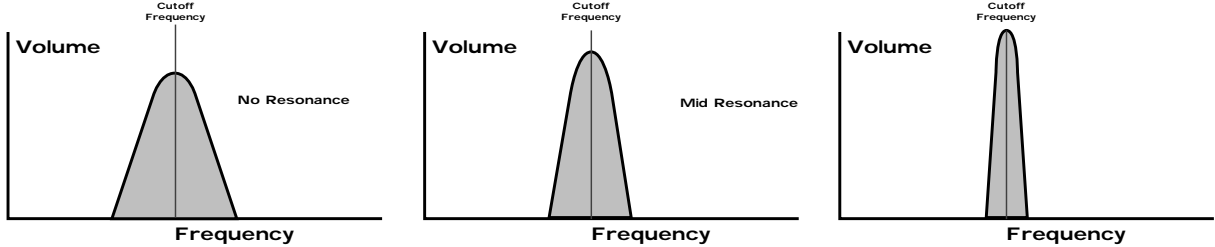

Band Pass Filter with Resonance Response Curves

AMPLIFIER - volume

The last major process that makes up a sound is its "Volume". The "Volume" of sounds vary as time goes by & so an Organ has very different volume characteristics than that of a Piano or String section. See the following diagrams for details.

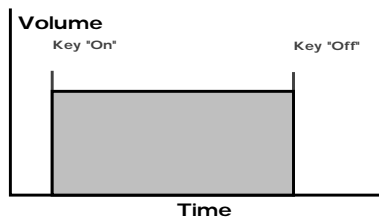

"Organ" Type Volume Response Curve

The "Organ" can be seen to go to full volume instantly when a key is pressed & then stay there until the key is released at which point the volume drops instantly to zero.

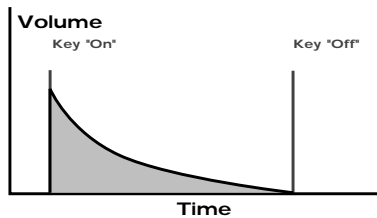

"Piano" Type Volume Response Curve

The "Piano" can be seen to go to full volume instantly when a key is pressed & then gradually fall back down to zero over several seconds.

ABOUT ANALOGUE SYNTHESIS

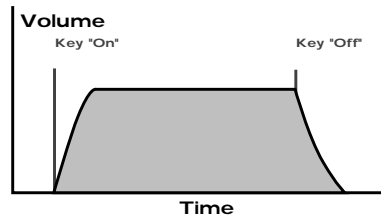

"String Section" Type Volume Response Curve

The "String section" can be seen to go to full volume gradually over several seconds when a key is pressed & then stay there until the key is released when gradually over a couple of seconds the volume drops to zero.

These curves are called "Envelopes" & in an Analogue synthesiser "Envelope Generators" are used to recreate them. Envelope Generators have 4 parameters which are used to adjust the shape of the envelope, see the diagram below:

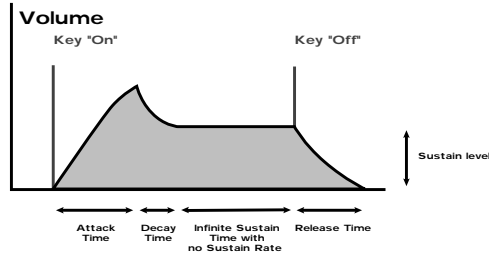

ADSR Type Volume Response Curve

Attack time is used to adjust the time it takes when the key is pressed for the envelope to go from zero to full value. (Fade in)

Decay time is used to adjust the time it takes for the envelope to go from full value to the value set by the Sustain level. (Piano like decay of volume)

Sustain level is used to set the level that the envelope remains at while the key is held down.

Release time is used to adjust the time it takes when the key is released for the level to go from the sustain value to zero. (Fade out)

The Nova II keyboard also offers additional envelope features to the classic ADSR types allowing even more flexibility, see the diagram below:

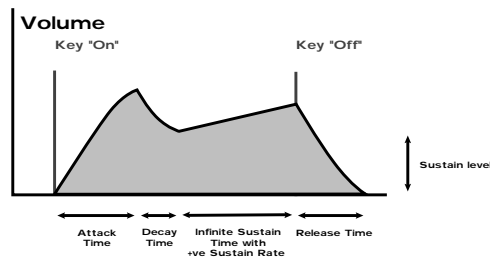

ADSR Type Volume Response Curve

In addition to the Attack, Decay, Sustain & Release parameters there is also 3 new parameters. These are:

Sustain Rate which is used to control the slope of the "Sustain" phase of the envelope. When this parameter is set to 0 the curve is normal like so:

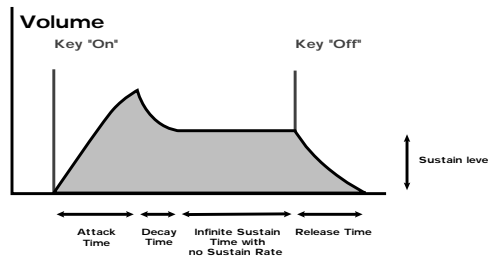

When this parameter has a +ve value, during the "Sustain" phase of the envelope the Sustain value will rise to full at a "Rate" determined by this parameter as can be seen below:

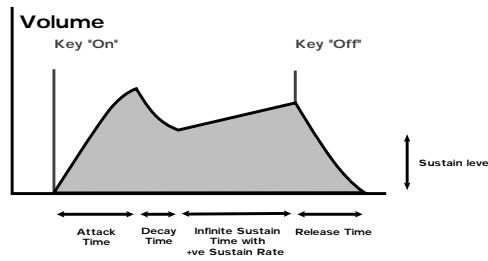

Low values like +01 will produce a very slow rise & high values will produce a quick rise to full intensity. When this parameter has a -ve value, during the "Sustain" phase of the envelope the Sustain value will fall to zero at a "Rate" determined by this parameter as can be seen below:

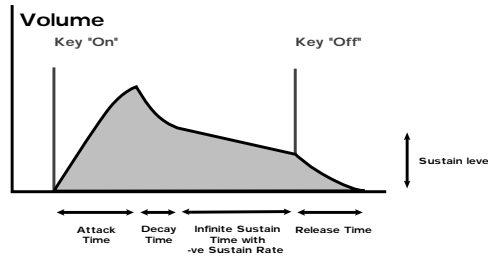

Low values like -01 will produce a very slow fall & high values will produce a quick fall to zero intensity.

A-D Repeat allows the Attack & Decay phases of the envelope to be looped, producing repeated cycles of Attack & Decay curves. This is fully adjustable from Off (normal ADSR operation) to 126 repeats & Infinity.

Sustain Time which is used to control how long the "Sustain" phase of the envelope will last. When this parameter is set to 127 (infinite) the curve is normal like so:

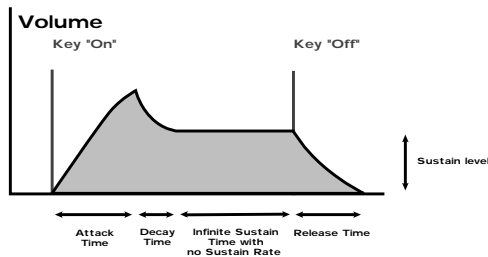

When this parameter is set to anything less than 127 the "Sustain" phase has a defined time duration & can be adjusted from very long to very short, so that the "Sustain" phase may end before the key played is released at which point the "Release" phase will start automatically. Below is an example of all 3 new parameters working together:

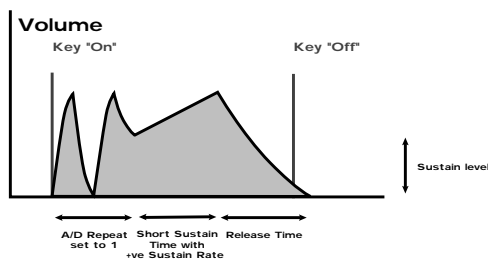

Summary

An Analogue Synthesiser can be broken down into three main elements.

- 1 - The Oscillator is the part of a synthesiser that generates "Waveforms" at a certain "Pitch".
- 2 - The type of "Waveform" selected in the Oscillator & the settings of the "Filter" determine the "Tone" of the sound.
- 3 - The sound is then passed through an "Amplifier" which is controlled by an "Envelope Generator". These alter the "Volume" of a sound over time.

ABOUT ANALOGUE SYNTHESIS

All of these three main elements can be controlled by various methods for example:

The "Pitch" of a note can be played on a keyboard or a synthesiser & additionally it can be manipulated in real time using the "Pitch Bend Wheel" to create "Slides" & "Bends" in pitch. LFOs (low frequency oscillators) can be used to "Wobble" the pitch of a note at a specific rate creating a "Vibrato" effect. An Envelope Generator can also be used to "Slide" the pitch in an automatic way.

The Filter can be manipulated by LFOs to vary the "Tone" of a sound at a specific rate creating a "Wah Wah" type of effect. An Envelope Generator can also be used on the Filter so that the "Tone" of a sound changes over time. A feature called "Keyboard Tracking" can also be used on the Filter so that the "Tone" of a sound changes depending on the note being played.

The Amplifier can be manipulated by Envelope Generators so that changes in the "Volume" of a sound over time can make the sound short & percussive, or more like a piano or even like an organ. Additionally the "Velocity" at which you hit the keys can also be used to manipulate volume making a sound more "expressive".

The elements that manipulate these three main synthesis elements are called "Modulation Sources".

The Nova II keyboard features 3 Envelope generators & 2 LFOs (Low Frequency Oscillators) as Modulation "Sources". In addition to this Velocity, (The dynamics of your keyboard playing. i.e. ppp to fff) Aftertouch (Pressure on the keyboard while note(s) are held) & the Modulation Wheel are included in a as additional "Sources" of modulation signals in a "Modulation Matrix". This allows almost any "Source" to modulate a given parameter. It is even possible to have combinations of different "Sources" modulating one parameter. In the Nova II keyboard this has been neatly arranged on the front panel so that accessing all the possible combinations of modulation is quick & easy. Below is the Modulation Matrix for the Oscillator section.

Oscillator Modulation Matrix



Simply by pressing the desired "Source" (the row of buttons on the right) & the desired "Destination" (the row of buttons on the left) & adjusting the "Level" or "Mod Depth" knobs allows the creation of complex modulation setups easily. On older modular Analogue Synthesisers this was done with "Patch" leads that physically connected the "Sources" & "Destinations" together.

This allows some very powerful performance features to be implemented. i.e. It is possible to sweep the "Sync" effect, "Harden" effect, Pulse Width Modulation & alter the Mix of all three oscillators independently plus open the Filter Cutoff Frequency, Reduce the Filter Resonance, add lots more Distortion & Delay & reduce the Chorus & Reverb, all by simply moving the Mod Wheel forward! With the Modulation Matrix relationships like this are quick to set up & will transform a "static" sound into one with real "hands on" control & flexibility.

This is where most synthesisers end. However, the Nova II keyboard features a very powerful Effects section. It could be said that effects are as much "part" of a sound as the raw sound itself. Some of the larger old Analogue systems had built in spring reverb, & with the development of DSP technology, digital effects have become available in modern synthesisers. However when in a "Multibrain" application, all the sounds are generally passed through one set of effects.

In the Nova II keyboard, a block of 7 effects is part of the "Program" & can be considered to be part of the synthesis engine. These include Distortion, EQ, Reverb, Rotary Speaker/Ensemble/Chorus/Flanger/Phaser, Delay, Panning & Comb Filter effects. These can simulate "Real World" effects like Echo & Room Reverberation etc. Or they can be used to just do really weird things to your sound! For details on what each effect does & how best to use them refer to the about Effects section part of this manual on page 18 for details.

The best thing to do is just get in there & tweak those knobs, after all that's why we put them there! Experiment & you'll soon be creating your own sounds. Don't worry about erasing the factory sounds in the memory. If you want, the factory sounds can be recalled. To do this Refer to page 52 for details.

Basic Theory

Earlier in this manual we were introduced to the basics of subtractive synthesis & became familiar with terms such as harmonics, timbre, waveforms & oscillators. FM Synthesis is the technique of using one waveform (Oscillator) to Frequency Modulate - FM - another to produce a resultant more harmonically complex waveform.

For purposes of illustration we will assume that the oscillators are producing sine waves.

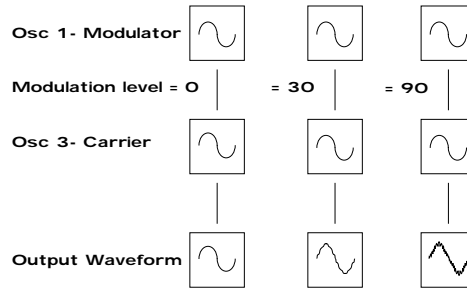

As we have already discovered it is the CHANGE in harmonics over time that starts to make a sound interesting to our ears. In FM synthesis an envelope generator is inserted between the modulator & carrier waveforms so we have control over of how much Frequency modulation is taking place with respect to time.

Adding this envelope makes the basic FM building block look like this

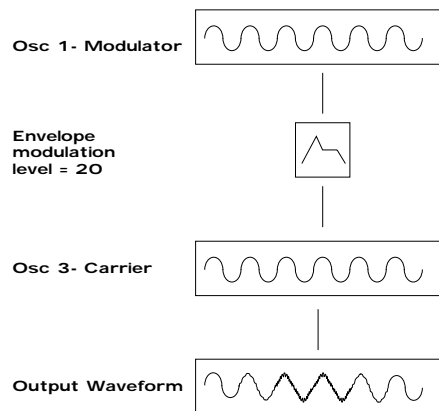

We can see that the output waveform starts off as the same as the carrier, becomes more complex (HARMONICS ARE ADDED) as the amount of FM modulation increases via the envelope, & then returns to a simple wave again as the envelope decays. THE TIMBRE OF THE WAVEFORM IS CHANGING WITH TIME. This is the opposite of subtractive synthesis where often a LOW PASS FILTER is used to REMOVE HARMONICS.

To complete this simple synthesizer we need to add one further envelope to control the volume of what we are hearing. The complete building block will now look like this.

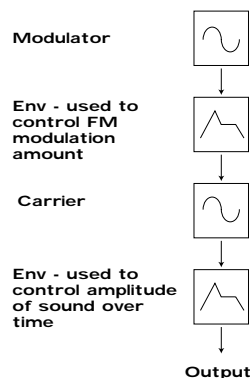

ABOUT FM SYNTHESIS

Yamaha popularised FM synthesis in the 1980's with the famous DX7 synthesiser. The basic building block of the original Yamaha machine was referred to as an OPERATOR. An operator is just one oscillator with one envelope generator that can control the output level of the Oscillator.

Referring to our simple synthesiser in the diagram above we can outline the different sections & see that it comprises of two blocks, each one containing one oscillator & one envelope. This is known as a 2 OPERATOR SYSTEM in DX7 Language

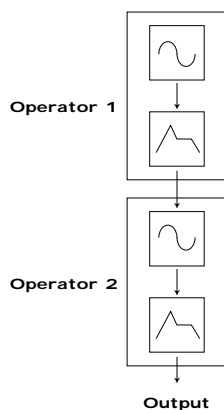

The DX7 had six operators & they were presented to the user in preset combinations referred to as ALGORITHMS. This terminology of OPERATORS & ALGORITHMS immediately presented users of this new digital technology with a mystifying machine interface, thus creating original sounds was very often left to professional programmers. We will make things clearer with the SUPERNOVA II so you may gain the knowledge to create your own FM sounds.

Programming of your own FM sounds using the Nova II keyboard.

In any one PROGRAM of the Nova II keyboard we can make up to 3 OPERATORS using the oscillators & envelopes available. We can also add a noise waveform for special effects & Drum/Percussion sounds. For simplicity most of the factory presets use the same structure as in the diagram below.

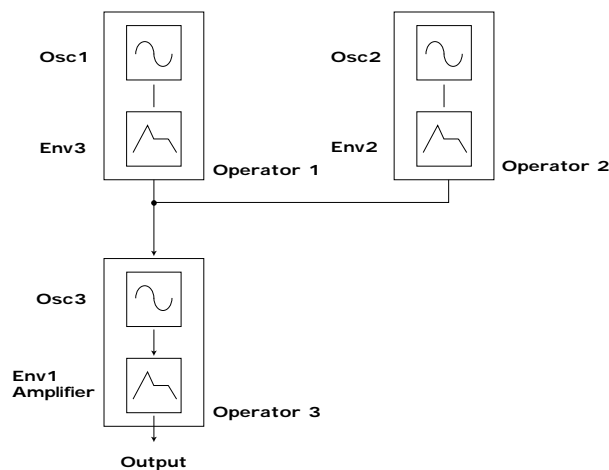

A Noise waveform maybe substituted for Osc1 or Osc2

Many musical instruments contain much of the detailed sonic information during the first few moments that the instrument is plucked, struck or blown. For example when a Xylophone is struck, during the small amount of time after the beater has made contact with the wood it will resonate & contain many harmonics. The sound will then settle down to a more periodic waveform.

The easiest way to learn & understand FM is to study a few of the factory presets. So lets start with the Xylophone

Select the FM sound Program D115"FMpt Xylo Lo".

When manipulating FM sounds most of the "tweaking" will be done in the using the envelope section & oscillator section.

Because we are now using an additive form of synthesis it is not really necessary to use the filter section. However it may be used to enhance the sound further if required.

When using the Nova II keyboard for FM synthesis it is important to note that it is ALWAYS Oscillator 3 that is heard as an output to the mixer section. If you are creating sounds from scratch we recommend using the program D126 "FM Init Program" as a starting point as all the oscillators are set to sine waves & only oscillator 3 has its mix level turned up.

Referring to the graphic above we have Oscillator 3 doing the "Body" of the sound. We then have Oscillator 1 via env3 Modulating Oscillator 1 for a small amount of time to simulate the effect of the beater. To hear just the body of the sound, press "osc3" in the Oscillator Section & press "solo". - Make sure that the button "fm" under the 1*3 is NOT LIT. Play the keyboard & listen to the sound. You are hearing a softened square wave that is in fact a sine wave. Whilst playing the keyboard press the "hardness" button & slowly rotate the "Level" knob. Notice how the sound becomes harder. Turn the knob back to so that the soften level is zero. Now press the "fm" button. You can hear the FM effect of Oscillator 1 coming in via envelope 3. The extra harmonics are now audible at the start of the sound & it resembles a real Xylophone.

The amount of time that this FM is taking place is controlled by env3. env3 is allowing an amount of Oscillator 1 to FM Oscillator 3. Experiment by selecting env3 in the Envelopes section & varying the decay time. Also Experiment with changing the pitch of Osc1. To do this press the "osc1" button & turn the "oct/semi" or "cents" knob.

A general rule in FM synthesis is that the HIGHER THE FM MODULATION AMOUNT, THE HARDER OR BRIGHTER THE SOUND BECOMES.

The real power of FM in the Nova II keyboard is the ability to "stack" programs into performances.

The Performance "FM Xylophone" in B025 is actually made from 2 programs. The program as described above (FMpt Xylo Lo) & FMpt Xylo Hi. From the names you can work out which program is doing what part of the sound !!!!!

To hear the 2 programs together select Performance B025. This is a layer of the 2 programs.

In terms of Operators this sound will now look like this in block diagram form.

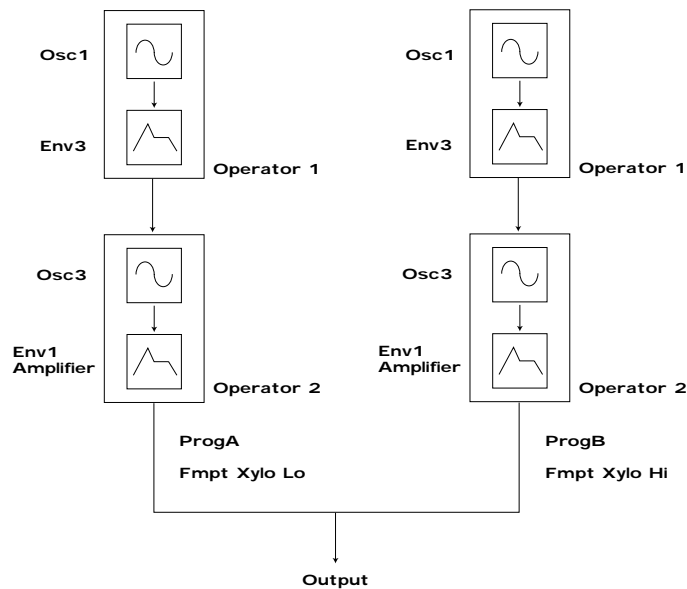

ABOUT EFFECTS

The Nova II keyboard's effect section is arguably one of the most powerful in a synthesiser of this type today. With all this power it is possible to obtain a level of production that was previously unattainable.

Effects can be "Effects" or they can be "Acoustic Simulations". Both are useful in the production of modern music, in fact they are almost essential. Clever use of effects can enhance a track beyond compare. However, slapping loads of effect on everything can do the reverse.

In the Nova II keyboard there are 7 effects units per Program. They are: Distortion, EQ (Equalisation), Comb Filter, Reverb, Rotary Speaker/Ensemble/Chorus/Flanger/Phaser (This is one effect that can be a Rotary Speaker or an Ensemble or a Chorus or a Flanger or a Phaser), Delay & Panner/Tremolo. Let's look at all of these effects one by one.

Distortion.

This is usually an effect reserved for Guitar players. As the name suggests, this has the effect of distorting the incoming signal as can be seen in the diagram below.



This effect not only gives the sound a hard edge & a dirty kind of quality, it also has several other characteristics that are worthy of note. Firstly, low level harmonics within the waveform are exaggerated. "Resonant" waveforms & indeed any resonance or additional harmonics will jump out if this effect is used. Secondly, the maximum level that comes out of the distortion effect is relatively constant so there is a definite compression effect as well. This can be useful for mixing, as the level of the sound is the same. The Distortion parameter as its name implies introduces Distortion.

EQ.

This effect is not normally found on most synthesisers, but is found on mixing desks & is very useful for fine tweaking the individual sounds to make them "fit" together in a mix. Very often a sound may be too "muffled" sounding or a bass too "twangy" sounding. This is where EQ comes in. Muffled sounds have insufficient treble, so adjusting the Treble EQ will either boost or reduce the treble. Similarly, the Bass EQ will either boost or reduce the bass. In the Nova II keyboard there is a Treble EQ control & a Bass EQ control.

Comb Filter.

This effect is a filter that generates many peaks in the frequency response of the signal. This can be seen in the frequency Response curve below.

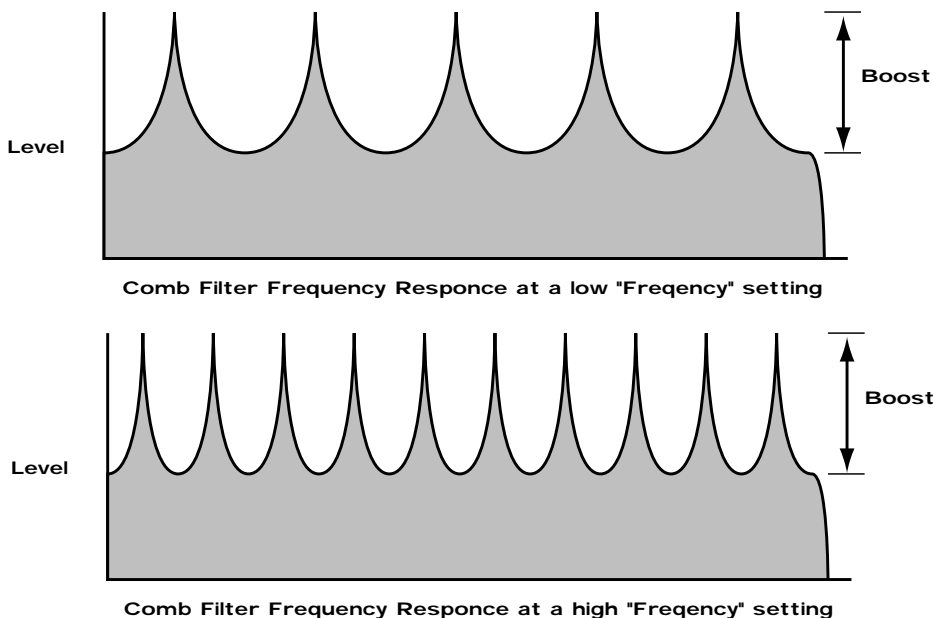

There are many peaks & they look like a "comb" hence the name Comb Filter. There are two parameters associated with this effect. Comb frequency controls the "frequencies" at which the peaks occur & Comb boost controls how high the peaks are. The effect is to alter the timbre of the sound. Although similar to EQ, this effect can produce effects not possible using a standard EQ. The resulting sound tends to be quite "Metallic" sounding especially when large "Boosts" are applied.

Reverb.

This is an "Acoustic Simulation of a room. Why does singing sound good in the toilet? Reverb that's why. The Reverb Effect is a computer model of the acoustics of a room. The type of room is up to you, anywhere from the toilet to the local Concert hall is possible. Below is a simplified diagram of the reflections of sound in a room. Note there are many reflections from all directions.

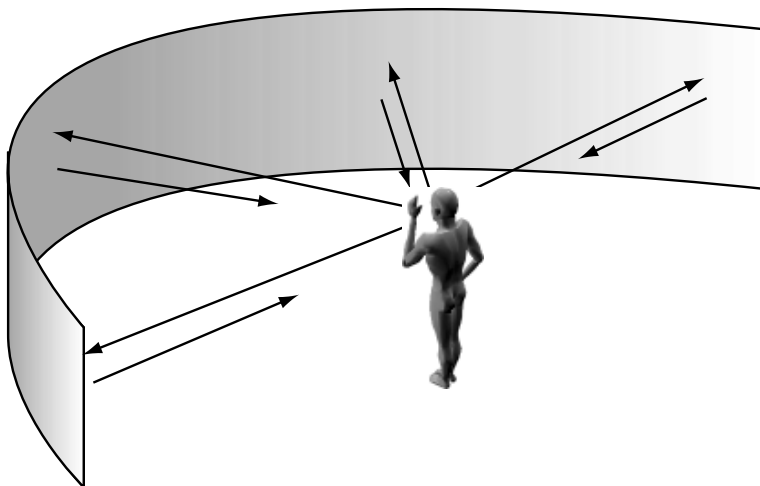

When the Reverb button is pressed, the knob in the effect section controls how much Reverb there is. Anticlockwise there is little effect This can be thought of as being very close to the sound source within the hall. Fully clockwise there is lots & this can be thought of as being at the other end of the hall from the sound source. Basically one way of looking at this parameter is "where you are & where the sound source is in the hall".

Different types of rooms & halls have different acoustics. For this reason, Nova II keyboard features several different Reverb types. These range from very, very small rooms like the "Dry Chamber" setting to the very large hall like the "Large type 2" setting. Additionally, "special" types have been included. These are "Gated" types & are an artificial type of reverberation that sustains for a period & typically dies away suddenly rather than smoothly decaying away as reverb does naturally. These types can be used as a special effect, especially on drums.

Most rooms have dominant large reflective surfaces (Larger walls typically) & these create dominant echoes in the reverberated signal. Early ref (reflection) level simulates these reflections. Large amounts of Early ref level will produce strong signal at the beginning of the reverb.

Decay Time is the time it takes for the Reverb to die away after the sound has stopped. This can be thought of a "what the hall is made of". Very acoustically reflective rooms tend to have long decay times & very non reflective rooms have short ones.

HF damp is short for High Frequency Damping. This controls the "tone" of the decaying Reverb. This can be thought of as the amount of carpet & drapes in the hall. Carpet & drapes tend to absorb high frequencies so as a sound "bounces" around the hall , giving you your Reverb effect. With each bounce the sound looses a little treble. No HF Damping is a little unusual in the "real" world but can be used to emphasise sibilant or trebly sounds. Normally a little HF Damping is applied to give the Reverb a natural kind of sound.

Rotary Speaker/Ensemble/Chorus/Flanger/Phaser.

This is one effect that can be a Rotary Speaker, Ensemble, Quad Chorus, Chorus / Flanger or a Phaser.

Rotary Speaker - an overview.

This effect is designed to simulate the effect created by a "Leslie" cabinet often used in conjunction with an Organ such as a Hammond B3. The effect was created by 2 separate speakers in the Leslie cabinet that are spun around independently with 2 motors. Hence the name of this effect, "Rotary Speaker". One of the speakers in the Leslie cabinet is a "Horn" (Tweeter) & the other is a "Rotor". (Woofer) The effect has 2 settings, a "Fast" setting, (where the speakers are rotating fast) a "Slow" setting (

ABOUT EFFECTS

where the speakers are rotating slowly) & a "Stopped setting". (where the speakers have stopped moving) The speakers are quite heavy so when changing from one setting to another the speed change is not instant but gradual due to the speakers inertia.

Ensemble - an overview.

This effect is designed to simulate the "Ensemble" effects found in classic "String Ensemble" keyboards like the Solina or the Roland SE101. This is similar to Chorus in the sense that Ensemble provides an effect that fattens up sounds & provides a stereo image but without the swirling sensation. It could in actual fact be thought of as 4 independent Choruses all running at different speeds, thus masking the "wobbly" sensation that Chorus can produce. This is particularly suitable for string sounds as it sounds smoother than Chorus for this purpose.

Chorus - an overview.

This is an effect originally designed to simulate the effect when many people sing together as opposed to one person or the sound of a 12 string guitar as opposed to a 6 string guitar. Chorus is an effect that is produced by detuning the signal slightly & mixing it back together with the original signal. The characteristic Chorus swirling effect is produced by an LFO that controls the amount of detuning the chorus performs.

Quad Chorus.

This is a effectively 4 Choruses running at once from one LFO but in different phases. This creates a particularly "thick" Chorus effect suitable for String Ensemble & other "Lush" sounds.

Chorus/Flanger.

Normal Chorus & Flanger effects are quite similar. Using this effect as a Chorus provides a Stereo effect with a smooth swirling sensation that fattens up sounds & provides a stereo image. This type of Chorus differs from the Quad Chorus in the sense that although not as "thick" sounding, this Chorus retains the "definition" of the effected sound making it more suitable for basses, organs & percussive sounds. The Flanger effect is similar to a chorus but tends to use more detuning & feedback to produce an effect with a pronounced swirling sensation that emphasises the harmonics in the sound as it sweeps through them.

Phaser.

This effect is almost the reverse of a Flanger. A small amount of phase shift is applied to the signal via an LFO. When this is added back together with the original signal, a pronounced swirling effect is produced that cancels out harmonics in a sound as it sweeps through them.

Chorus Speed. This parameter controls how fast the LFO for this effect is going. Generally a fairly slow speed is used. Higher speeds tend to induce a vibrato like quality to the sound.

Mod Depth controls the amount of detuning or phase shift that the effects LFO produces. Again large amounts of modulation from this parameter will produce a more noticeable effect. Generally moderate amounts are used but you will find that bass sounds benefit with more Mod Depth than normal. Feedback controls how much of the treated signal is fed back into the input. Subtle effects like chorus benefit from low levels of feedback. Flangers & Phasers on the other hand sound better with more feedback. Feedback emphasises the harmonics in a Flanger & emphasises the cancellation of harmonics in a Phaser.

The Type parameter determines if this effect is going to be a Chorus or a Flanger or a Phaser. Select the one you want.



The effects LFO should not be confused with the front panel Program LFOs.

Delay.

This effect is normally a single acoustic reflection of a sound. This is commonly called Echo. This effect can be heard naturally anywhere where there is a large flat surface, like a concrete wall. A "Stereo" version can be considered to be two concrete walls & this is the type that the Nova II keyboard uses. The distance from the walls determines the delay time & in the example below the distance between the left wall & left ear of the listener is different to the distance between the right wall & the right ear of the listener. This creates a Stereo "staggering" effect of the echoes & is normally referred to as "Multi Tap Delay" or "Tap Delay".

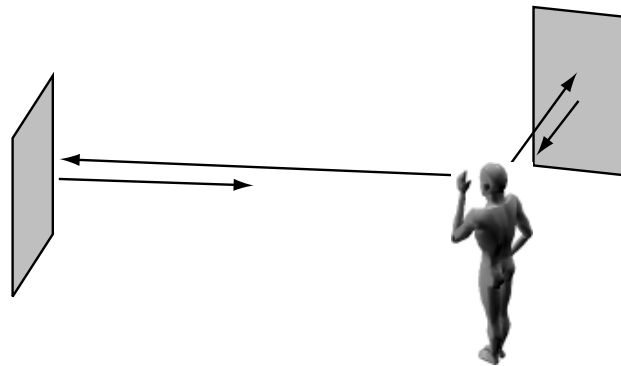

Delay Time. This parameter controls the amount of time it takes for the delayed signal to be heard after the original signal. In the example given above this is the same effect as the distance you are from the wall. A large distance produces a long delay & a short distance produces a short delay. In the Nova II keyboard, the Delay time is the time of the Longest delay. The shorter delay will be a percentage of this value. See "Ratio" below.

Feedback. This parameter controls how much of the delayed signal is fed back into the delay's input. No feedback produces a "Slapback Echo" effect, that is just one delayed signal with no repeats. Small amounts of feedback produce "repeated" signals giving the "Echo" effect. This can be thought of as standing in-between two parallel concrete walls. The sound bounces back & forth between them. In this case the Decay Time represents the distance between the walls.

HF Damping. HF Damping is short for High Frequency Damping. This controls the "tone" of the decaying Echo. This can be thought of as the amount of drapes on the walls. Drapes tend to absorb high frequencies so as a sound "bounces" from wall to wall, giving you your Echo effect, with each bounce the sound loses a little treble. No HF Damping is a little unusual in the "real" world but can be used to emphasise sibilant or trebly sounds. This characteristic was found in older "Tape" based echo units. Higher values of this parameter simulates the effect of worn out tape or heads in a tape echo. Normally a little HF Damping is applied to give the Echo a natural kind of sound.

Delay Ratio. The Ratio parameter automatically adjusts the "Ratio" of the Longest Delay time & the shorter Delay time into timings that are useful for Musical use. This parameter does not effect the Delay Time parameter but does alter the shorter Delay time so that it works well with the Delay Time setting.

Width is the Stereo spread between the long & shorter Delay times. At a width of 0, both delays appear in the middle of the stereo field. (Mono) At a width of 127, the long delay will appear on one output & the shorter delay on the other producing a dramatic stereo effect.

Pan.

This effect controls where the sound "sits" in the stereo field. In the Nova II keyboard this performs exactly the same function as Pan does on a Mixing console. It can be used to statically position a sound anywhere from Left to Right in the stereo field. This (as everything else on Nova II keyboard) can be controlled via MIDI controllers.

Pan Type determines if the Pan is set to Pan automatically. If set to "Autopan" the sound will swing from side to side of the stereo field at a rate determined by the Speed parameter. If set to "Tremolo" the sound goes up & down in volume at a rate determined by the Speed parameter.

Pan Speed determines the speed of the Autopan & Tremolo effects.

Pan Depth determines how much the Autopan & Tremolo effects control the Volume of the sound, small amounts produces subtle movements & full amount produces change from no sound to full volume.

A Translation of terms used throughout this manual.

In this manual there are several terms used that may lead to confusion if not fully understood. Below is an explanation of all the Novationish used in this manual

Program

This is the simplest type of sound Nova II keyboard can create. These are accessed by pressing the Program button. Other Manufacturers sometimes call these Patches or Partials.

Drum Map

This is the special arrangement where many Programs are arranged across the keyboard (one for each note) & are all accessed simultaneously. The Drum Maps are accessed by pressing the Program button & the Bank buttons. Other Manufacturers sometimes call these Drumkits.

Performance

This is the most complex type of sound Nova II keyboard can create. It is made up of 6 different sounds called Parts. These Parts can be layered or set up as splits to form the Performance. Performances are accessed by pressing the Performance button. Other Manufacturers sometimes call these Multis, Multisetups or Combinations.

Part

This is one of the 6 sounds or Parts of a Performance. The sound assigned to a Part is called a Program. Other Manufacturers sometimes call these Timbres.

Favourites

This is a special set of memories storing all your "Favourite" Programs & Performances These are accessed by pressing the Favourites button.

Voice

This is a measurement of polyphony. One voice is the equivalent of one note being played. One voice in the Nova II keyboard uses three Oscillators, two Ring Modulators & a Noise generator as sound sources. All these sound sources can be used simultaneously in one Voice.

Oscillator

This is the basic waveform generator in the Nova II keyboard. As described above there are three Oscillators per Voice.

Sync Effect

This is a parameter of one oscillator that simulates the "Sync Effect" generated by 2 Analogue oscillators in a "Oscillator Sync" configuration. For more details refer to page 7 - About Analogue Synthesis.

Hardness Effect

This is a parameter that controls the harmonic content of any waveform. Full Hardness Effect on a waveform produces a normal wave. Minimum Hardness produces an near sine wave. This is similar to having a separate LPF for each oscillator. For more details refer page 9 - About Analogue Synthesis.



Analogue Sound Modelling™

This is the Synthesis System the Nova II keyboard uses to create sound. Created by Novation, this new method of synthesis was first used in the Award winning Novation Drum Station.



NOTE:

When this symbol appears in the manual this indicates an important feature, or a destructive function such as Writing data to memory etc.

There are 3 types of "Sounds" you can select in the Nova II keyboard. These are Programs, Drum Maps & Performances.

When the Program Button is selected a single Program is recalled from memory. A Program is the most basic type of sound in the Nova II keyboard. This sound is made up of the 3 oscillators, the 2 ring modulators & the noise generator. These are Mixed together & are fed through the Filter, Amplifier & effects processors. The sound produced by a Program in Program Mode comes out of outputs 1 & 2. A Program uses the "Global MIDI Channel" to receive MIDI Data. A Program covers the entire range of notes on a keyboard & has the standard velocity curve. On other synthesisers, a "Program" is sometimes referred to as a "Patch" or "Partial". This is fairly standard amongst synthesisers except the Nova II keyboard differs in 2 areas.

Firstly, the Effects Section is memorised with the Program. Although this may seem standard in comparison to other equipment, the real difference happens when a Performance is selected. Because the Nova II keyboard can run 42 Effects at once, all 6 "Parts" of a Performance have their own Effects Section. This allows all the "Parts" of a Performance to sound exactly the same in Performance mode as they do in Program mode. This is unique to the Nova II keyboard & is literally like having the equivalent of 6 separate synthesisers with 6 sets of effects sections allowing a very high level of production to be achieved with just one box.

Secondly, the Arpeggiator Sections parameters are also memorised with a Program. Similarly because the Nova II keyboard can run 6 Arpeggiators at once, all 6 "Parts" of a Performance have their own Arpeggiation.

Below is a simplified block diagram of a "Program" in the Nova II keyboard.

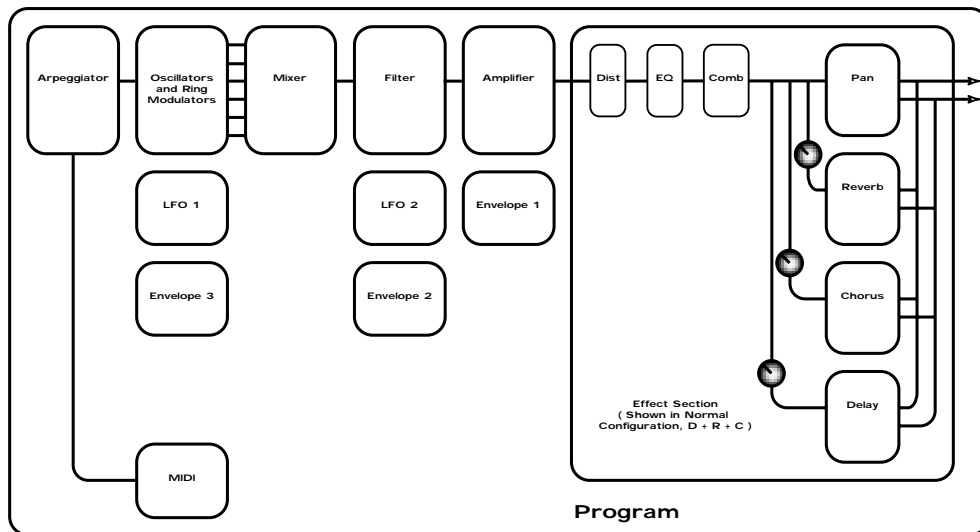

In a Program, incoming MIDI messages get processed by the Arpeggiator (If it is "On") & control the Oscillators. The signals produced are mixed together in the Mixer section & the resulting signal is passed on to the Filter. The signal then is passed to the Amplifier which then sends the signal into the effects section. This signal path is reflected on the front panel of the Nova II keyboard allowing easy understanding of the synthesis process. All the essential controls of this process are on the front panel & in Program mode, adjusting the controls will directly effect the sound produced. For a deeper understanding of the creation of sounds refer to the section "About Analogue Synthesis" on page 6 for details.

ABOUT DRUM MAPS

A Drum Map is a special way of playing Programs. Normally a Program is transposed & is played over the entire range of the keyboard. In a Drum Map each program is assigned to a single note on the keyboard & every note from C1 (bottom C on the keyboard) to B4 plays a different program. Basically a separate "Program" is assigned to each note in a Drum Map. This allows the keyboard to access different Drum sounds on each key. This is particularly useful when using the Nova II keyboard with a sequencer as a Drum Map can be assigned to a single "Part" of a Performance allowing many different drums to be played on one MIDI channel. Each Drum Map contains 50 Programs. Below is a block diagram of a Nova II keyboard Drum Map.

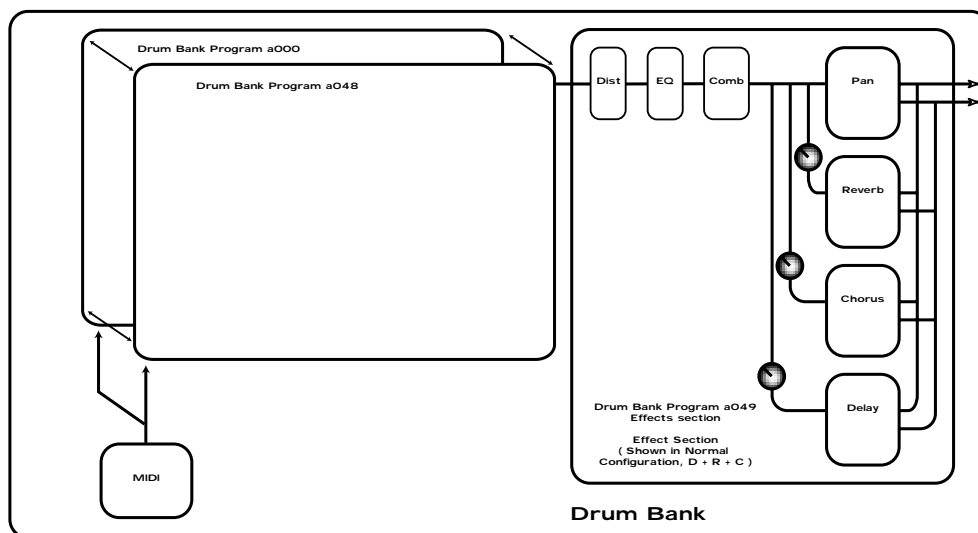

The incoming note data is split up & fed to one of the 50 Programs in the Drum Map. These programs are 000 to 49. Drum Map Programs 000 to 048 are for storing sound data. The output of all these programs is mixed together & fed through one effects section. The effects sections parameters are stored in Drum Map Program 049, however adjusting the effects section of any Program within a particular Drum Map will alter the effects on Drum Map Program 049 & hence the whole Drum Map. When a Drum Map program is saved the sound data is stored in the desired location & any edits to the effects data is stored in Drum Map Program 049. Effects settings from other programs can be imported into a Drum Map by saving the Program that has the desired effects in Drum Map Program 49.

In the Nova II keyboard there are 4 Drum Maps.



NOTE:

Adjusting the effects of any Drum Map Program will affect all the sounds in the entire Drum Map.



NOTE:

Any Program written into Drum Map location 049 will not make a sound but will write the source Programs effects on the entire Drum Map.



NOTE:

It is possible to write a "normal" type of Program into a Drum Map & write a Drum Map Program into a "normal" Programs location using write procedure.

A Performance is a more complex arrangement where several Programs can be used at once. This allows the creation of much more complex sounds that are either layered together to create a "Fatter" sound or a Split of 2 or more sounds on the keyboard. In fact a Performance consists of up to 6 "Parts". Each one of the parts can have its own Program & as explained before this means each "Part" has its own Effects Section & Arpeggiator. This means it is possible to layer up to 6 Programs or create a 6 way split of different sounds across the keyboard or any combination of the two. Below are some examples.

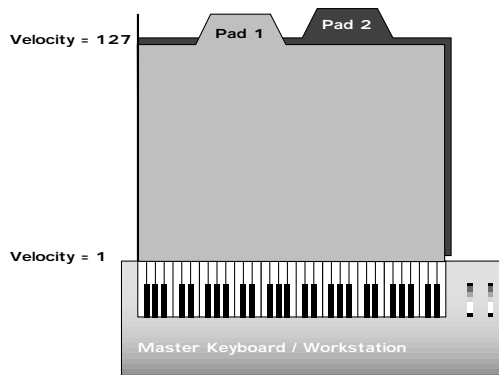

Keyboard Range
PERFORMANCE LAYER EXAMPLE

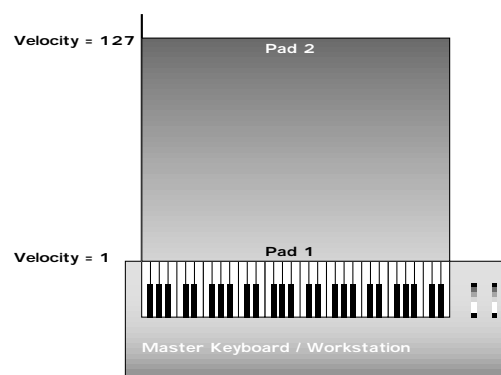

Keyboard Range
PERFORMANCE VELOCITY CROSSFADE EXAMPLE

In the Performance Layer example there are 2 Pad Programs layered together over the entire range of the keyboard. Playing any one note will play both the sounds on that note. In the Velocity Crossfade example playing the keyboard softly will mean Pad 1 is heard, playing the keyboard hard & Pad 2 will be heard, playing the keyboard with medium feel will produce a mixture of Pad 1 & Pad 2.

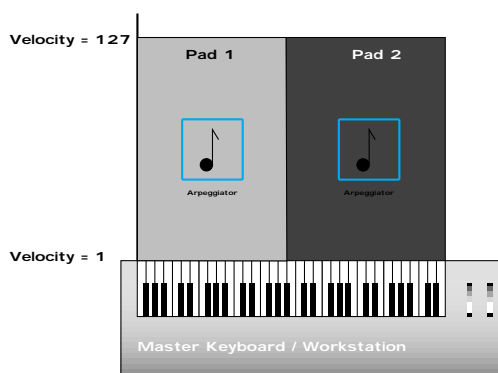

Keyboard Range
PERFORMANCE SPLIT EXAMPLE

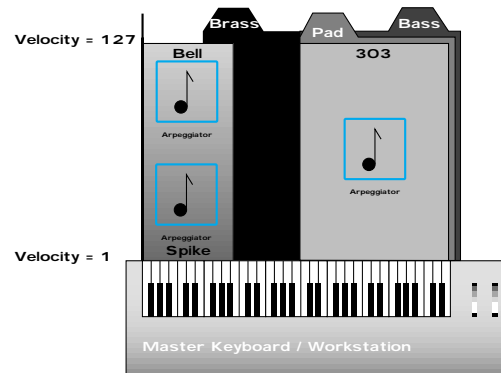

Keyboard Range
PERFORMANCE MULTIPLE EXAMPLE

In the Performance Split example, play the higher end of the keyboard & Pad 1 will be heard. Play the low end & Pad 2 will be heard. Additionally to this, it can be seen that different Arpeggiators are assigned to the Lower & Upper parts of the keyboard. Both of these can be played at the same time. The Performance Multiple example is much more complex, a Performance can have 6 "Parts", in this case 7 have been used. The lower half of the keyboard is a 3 way layer of Programs. There is a Pad, a Bass & an Arpeggiated 303 sound. These all sound at the same time when a note is pressed within their range. A little further up the keyboard a Brass sound has been assigned & when the keyboard is struck hard a Ring mod FX is added. Further up the keyboard still there are 2 Arpeggiated sounds assigned. They are arranged in a Velocity crossfade so that playing the keyboard in this range softly produces a Spike sound with an Arpeggiation & playing it heavily produces a Bell sound with a different Arpeggiation. To set the split points use the "Range" Parameter to specify over which "Range" of notes the selected "Part" will sound. To set the velocity crossfades use the "Velocity Curve" Parameter to specify how the selected "Part" will respond to velocity.

Performance mode is also the mode in which you can use Nova II keyboard "Multitimbrally". This allows Nova II keyboard to play up to 6 different sounds simultaneously on 6 different MIDI Channels. Each "Part" of a Performance can have a separate MIDI channel setting. This is how you use the Nova II keyboard Multitimbrally.

ABOUT PERFORMANCES

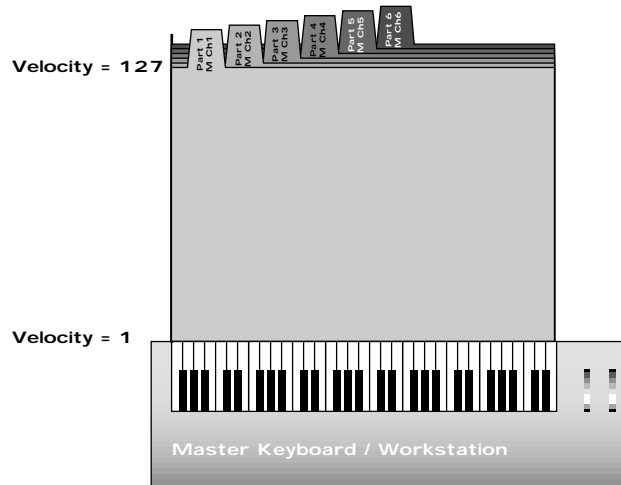

Keyboard Range

MULTI TIMBRAL PERFORMANCE EXAMPLE

Above is an example of 6 different sounds assigned to 6 different MIDI Channels. Set the individual "Parts" to the required MIDI channels & make sure the "Part" Ranges are set to cover the full range of the keyboard & Velocities are set to the normal setting otherwise unexpected results may occur. Also it can be seen that combinations of Multitimbral & Split/Layered Performances can be made, for example a performance could be set up so that parts 1 to 4 were assigned to MIDI Channels 1 to 4 & part 5 & 6 assigned to MIDI channel 5 with key ranges set for parts 5 & 6 so that a split is created.



NOTE:

When a Program change message is received on the Global MIDI channel it will change the selected Program or Performance. If a Program change is received on a Part MIDI Channel that is not the Global one it will change the assigned Program for that Part. When it does so the effects settings stored in the Program will be loaded into the Parts Effects section if the Effects used parameter in the Output menu is set to "Program". If this parameter is set to "Performance" the Program will change but the effects setting for that part will not be altered. Additionally the Arpeggiator Parameters from the Program will be loaded into the Part's Arpeggiator.



NOTE:

There is only one Arpeggiator Speed control in a Performance. Adjusting the speed of any Parts Arpeggiator will control all 6 Arpeggiators.

Below is a simplified block diagram of a "Performance" in the Nova II keyboard.

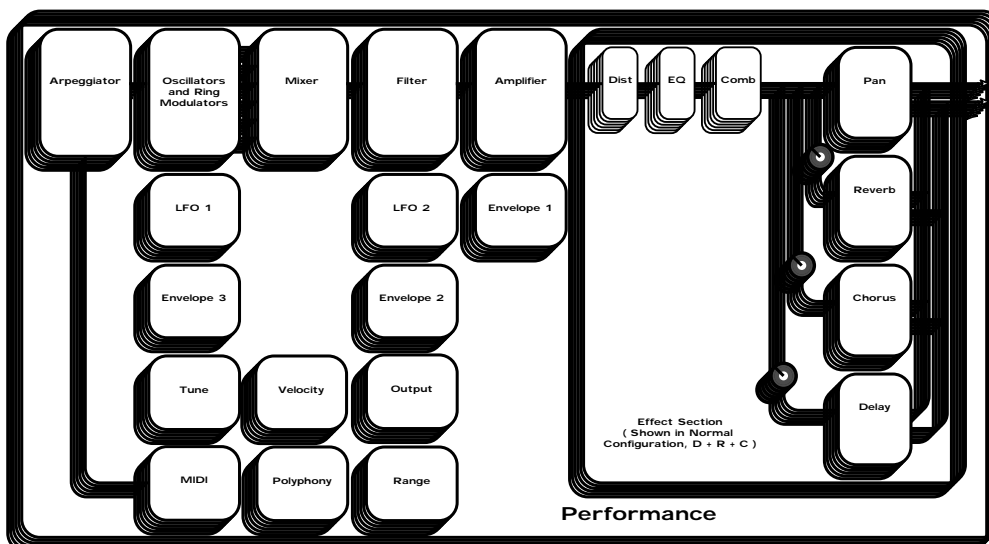

A Performance is literally a duplication of 6 Programs, including the Effects Sections & the Arpeggiators.

The Nova II keyboard features a "Favourites Section" that allows any 2 button selection made on the Keypad section or any incoming MIDI Program Change command to call up any Program or Performance from any Bank, or select a new Arpeggiator Pattern for the currently selected program. The Favourites Section is user programmable & is Memorised as Global.

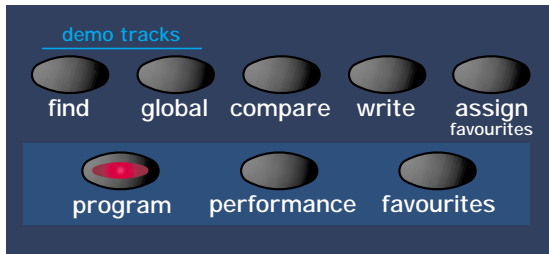

To select the Favourites Section simply press the Favourites button in the Mode section or send a MIDI Bank Message of 0 (Controller 32 with a value of 0).

To select a Favourite requires a maximum of only 2 button presses, even if the number has 3 digits. For example to select Favourite 111, make sure the Nova II keyboard is in the Favourites mode (the Favourites button is lit), & simply press the 110 button & the 1 button in the Keypad section & the display shows:

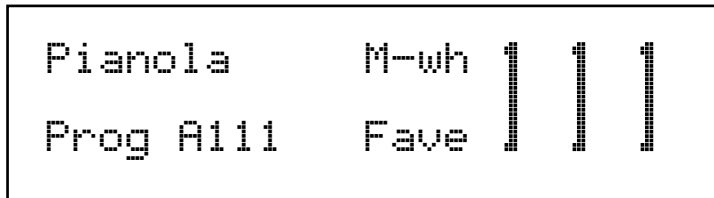

To select Favourite 001, make sure the Nova II keyboard is in the Favourites mode (the Favourites button is lit), & simply press the 0 button on the top row of the Keypad section & the 1 button on the bottom row of the Keypad section. In some cases only one button press is required, for example if Favourite 111 is currently selected, to select 112 only requires the 2 button to be pressed.



NOTE:

The Favourites map can be made active via MIDI at all times by setting the "Incoming program change" parameter on page 13 of the Global mode to "Favourites".



NOTE:

The Favourites mode can be memorised as the power up default made by saving the Global data when this mode is selected. This allows Master Keyboards trying to control the Nova II keyboard which do not transmit Bank Select Messages to be able to call up any Program or Performance in any Bank.



NOTE:

When a Program/Part receives a valid Bank Select Message (Controller 32) via MIDI IN, the bank will continue to remain selected for the Program/Part until another Bank Select Message is received via MIDI IN.



NOTE:

This "Favourites" mode is assigned to MIDI Bank 0(Controller 32 with a value of 0). If this message is received the Nova II keyboard will switch from normal operation to the Favourites mode. Any Program changes received after that will be re-mapped according to the Favourites map. This can be disabled by sending another MIDI Bank Message calling up either one of the Program or Performance Banks. See page 137 for details on the Bank Messages received by Nova II keyboard.

ASSIGNING FAVOURITES

To assign a Program or performance to a specific Favourites location is easy. Simply select the desired Program or performance using the Program or Performance buttons in the Mode section, the Bank buttons & keypad section.

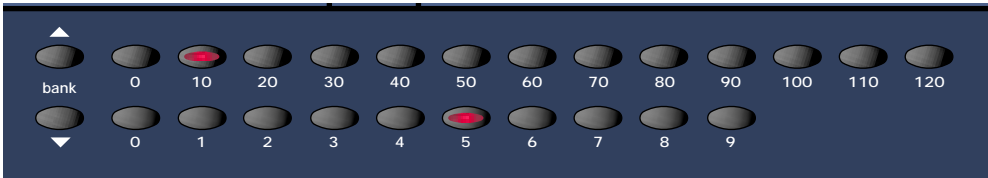
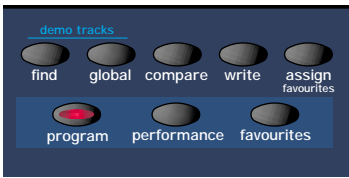

Now press the Assign (favourites) button in the Mode section & it will light to show it is active. Select the Destination "Favourite" while in this mode by pressing the appropriate flashing buttons on the keypad. The display will show:

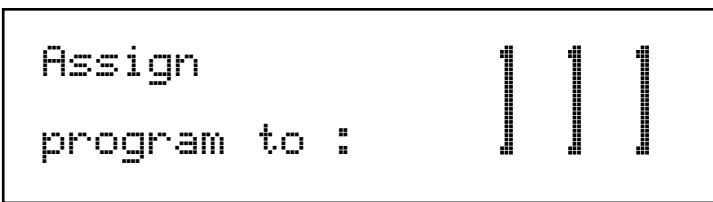

Press the Assign (favourites) button again & the display shows this message momentarily:

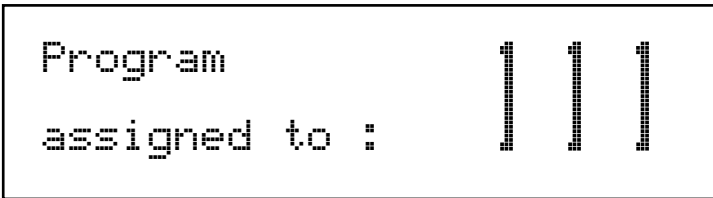

Indicating that the program has been assigned to Favourite 111. It is possible to assign all your "Favourites" in this way but the assignments are not actually written to Flash memory until a write procedure has been done. Now to write this into flash press the Favourites button to enter the Favourites mode & press the Write button.



NOTE:

If the Write button is not pressed while in Favourites mode the Flash memory will not be written & all assignments will be lost on power off.

It is also possible to assign Arp Pattern changes to Favourites. To do this enter the Arp menu & go to page 1 where the display shows the Pattern bank & Pattern Number parameters. Select the Bank & Pattern to be assigned. Press the Assign Favourites button & set the Favourites location for the Pattern assignment using the Keypad buttons. Press the Assign button again to confirm the assignment. Press the Write button to write the assignment to Flash memory.



NOTE:

If the Write button is not pressed while in Favourites mode the Flash memory will not be written & all assignments will be lost on power off.

It is also possible to assign "Current" program changes to Favourites. "Current" means a program or performance will be selected at a specified location within the "Currently" selected bank. You could think of this as Favourite that is just a program change without the bank change data. To do this enter the Favourites mode. Select the desired "Current" value with the keypad section. Press the Assign Favourites button & set the Favourites location for the Current assignment using the Keypad buttons. Press the Assign button again to confirm the assignment. Press the Write button to write the assignment to Flash memory.



NOTE:

If the Write button is not pressed while in Favourites mode the Flash memory will not be written & all assignments will be lost on power off.

INSERTING A FAVOURITE INTO AN EXISTING FAVOURITES MAP

When setting up a Favourites selection it is quite possible that there may be a situation where a new "Favourite" may need to be inserted within an existing arrangement of Favourites. To this end the Nova II keyboard features a special mode where a new Favourite can be inserted within an existing map, moving all the following Favourites up one position.

Firstly select the Favourite location at which a Favourite is to be inserted. In this case the selection is Favourite 111 & the display shows:

```
Pianola      M-wh  |  |  |
Prog A111    Fave |  |  |
```

Now press the Page up button & the display shows:

```
Insert favourite ?
Write to insert
```

Now pressing the Write button in the Mode section will insert a default Favourite into location 111 & shift all Favourites above Favourite 111 up one location. Pressing the write button & the display momentarily shows:

```
New favourite
inserted.
```

Then the display will show the default Favourite inserted at location 111. You can then assign any new Program, Performance or Arp pattern to this new location.



NOTE:

If the Write button is not pressed while in Favourites mode the Flash memory will not be written & all assignments & edits to the Favourites map will be lost on power off.



NOTE:

When a Favourite is inserted, Favourite 127 is lost as all the preceding favourites are moved up one location.

DELETING A FAVOURITE FROM AN EXISTING FAVOURITES MAP

When setting up a Favourites selection it is quite possible that there may be a situation where a "Favourite" may need to be deleted within an existing arrangement of Favourites. To this end the Nova II keyboard features a special mode where a Favourite can be deleted within an existing map, moving all the following Favourites down one position.

Firstly select the Favourite location at which a Favourite is to be inserted. In this case the selection is Favourite 111 & the display shows:

```
Pianola      M-wh  | | |
Prog A111    Fave | | |
```

Now press the Page down button & the display shows:

```
Delete favourite ?
Write to delete
```

Now pressing the Write button in the Mode section will shift all Favourites above Favourite 111 down one location & insert a default Favourite into location 127. Pressing the write button & the display momentarily shows:

```
Favourite deleted.
```

Then the display will show the default Favourite that was at location 112, which the Nova II keyboard has moved down one location to 111.



NOTE:

If the Write button is not pressed while in Favourites mode the Flash memory will not be written & all assignments & edits to the Favourites map will be lost on power off.



NOTE:

When a Favourite is deleted, a new Favourite at location 127 is created as all the proceeding favourites are moved down one location.

The Multi Mode for Nova II keyboard is "Performance" mode. To make a multitimbral setup follow this procedure. Make sure the Nova II keyboard is in the Performance Mode by pressing the Performance Button. It will light. We suggest that you use Performance A 126 "Multi Ch 1-8" of the Performances as a starting point as this is set up specifically for Multitimbral use & is a good starting template.

To assign a Bass sound to MIDI Channel 1 for example, press the "Part 1" button & the display will change to indicate the current sound assigned to that Part. (In the Factory Programs this is Bank A Program number A000 "Sintillator") Now use the Bank & Prog buttons to select the desired sound. For example Bank A Prog Number 002 "Softena Bass". In Perf A126, Part 1 is assigned to MIDI channel 1, Part 2 is assigned to MIDI channel 2 etc. etc. (If you wish to alter the MIDI channel setting press the "MIDI" button & set the MIDI Channel to whatever channel required). You should now hear the Bass sound when MIDI channel 1 is played into the Nova II keyboard. If you wish to assign the Effects from the Program to the Part then press the "Output" button & set the parameter "Effects used" to Program.

To assign a String sound to MIDI Channel 2 for example, press the "Part 2" button & the display will change to indicate the current sound assigned to that Part. (In the Factory Programs this is Bank A Program number A000 "Sintillator") Now use the Bank & Prog buttons to select the desired sound. For example Bank A Prog Number 012 "Stringz". In Perf A126, Part 1 is assigned to MIDI channel 1, Part 2 is assigned to MIDI channel 2 etc. etc. (If you wish to alter the MIDI channel setting press the "MIDI" button & set the MIDI Channel to whatever channel required) You should now hear the String sound when MIDI channel 2 is played into the Nova II keyboard. If you wish to assign the Effects from the Program to the Part then press the "Output" button & set the parameter "Effects used" to Program.

To assign a Drum sound to MIDI Channel 3 for example, press the "Part 3" button & the display will change to indicate the current sound assigned to that Part. (In the Factory Programs this is Bank A Program number A000 "Sintillator") Now use the Bank & Prog buttons to select the desired sound. For example Bank A Prog Number 006 "Garage Kick M-Wh". In Perf A126, Part 1 is assigned to MIDI channel 1, Part 2 is assigned to MIDI channel 2, Part 3 is assigned to MIDI channel 3 etc. etc. (If you wish to alter the MIDI channel setting press the "MIDI" button & set the MIDI Channel to whatever channel required) You should now hear the Drum sound when MIDI channel 3 is played into the Nova II keyboard. If you wish to assign the Effects from the Program to the Part then press the "Output" button & set the parameter "Effects used" to Program.

The other Parts are assigned in a similar way & 6 Parts can be used at once. If 2 or more Parts are assigned to the same MIDI Channel all these Parts will sound at once when that MIDI channel is received by Nova II keyboard.

Some parameters of a Program in a "Part" of a Performance are over-rideable without having to alter the original Programs settings. These include the "Level" of the Program, the Arpeggiator "Speed" the "Arpeggiator On/Off" and *all* the Effects parameters if the Effects used parameter in the Parts Output menu is set to "Part". This allows the creation of completely different effects settings on a individual Part without effecting the source programs settings. The Part can be optimised so that when Program changes are received on that Part the Nova II keyboard will keep the settings you have made in the Performance & ignore the settings of the newly selected Program. This is done by setting the Effects used parameter in the "Output Menu" to "Part". Alternatively, the whole of the effects can change when a Program change message is received by a Part by setting this parameter to "Program". Pressing the "Copy" button in the effects section activates a Copy mode where the Parts Program effects are copied into the Part effects buffer.

Only one Performance is available at any time. It is not possible to create a Multi type setup with multiple Performances.



NOTE:

When a Program change message is received on the Global MIDI channel it will change the selected Program or Performance. If a Program change is received on a Part MIDI Channel that is not the Global one it will change the assigned Program for that Part. When it does so the effects settings stored in the Program will be loaded into the Parts Effects section if the Effects used parameter in the Output menu is set to "Program". If this parameter is set to "Performance" the Program will change but the effects setting for that Part will not be altered. Additionally the Arpeggiator Parameters from the Program will be loaded into the Part's Arpeggiator.



NOTE:

There is only one Arpeggiator Speed control in a Performance. Adjusting the speed of any Part's Arpeggiator will control all 6 Arpeggiators.

If you create your own from existing Performances other than the Factory Init Performances, parameters may have been set in individual Parts so that in a multi setup strange things may happen. Here's the check list:

Velocity behaves strangely on one Part - The Velocity Curve parameter in the Velocity menu is *not* set to "Normal".

The Part is Monophonic & should be Poly - The Polyphony parameter in the Polyphony menu is set to "Mono".

The Part is polyphonic & should be Mono - The Polyphony parameter in the Polyphony menu is set to "Poly".

MULTITIMBRAL USE

The Part is Muted / No response at all - If the Part light flashes steadily, even with no MIDI input, the Part is Muted.

The Part is Muted / No response at all - Does the Part light flash when MIDI is sent?

- Yes - The Assigned outputs may be different to the ones connected, check the setting of the Outputs menu for the offending Part.
- No - The MIDI Channel for the Part is set to the incorrect channel in the MIDI menu.
- No - Polyphony parameter in the Polyphony menu is set to "Off".

The Part is in a different key to the others - The Part Semitone parameter in the Tune menu is *not* set to "0"

The Part is in a out of tune with the others - The Part Detune parameter in the Tune menu is *not* set to "0"

The sustain pedal behaves in reverse on the assigned Part - The Polarity of the pedal is set incorrectly, set the Sustain parameter in MIDI menu to "Enable" or "Enable (i)" so that the desired effect is produced.

The Sustain pedal does not work on the assigned Part - The Sustain parameter in the MIDI menu is *not* set to "Enable" or " Enable (i)".

SELECTING PROGRAMS, PERFORMANCES & FAVOURITES

There are a lot of sounds in Nova II keyboard & they are arranged into "Banks". There are 2 Banks of 128 Performances, (256 Performances in total) 4 Banks of 128 Programs, (512 Programs in total), 4 Drum Maps each with 50 Programs & 1 Bank of 128 Favourites. Pressing the Program button will activate the Program Mode & the display will show:

```
Sintillator M-Wh
                    Prog A000
```

Program mode has been selected because the Program button is lit & the bottom line of the display is indicating "Prog" followed by the Bank & number of the sound. The top line is displaying the name of the sound.

Pressing the Bank up button & the display changes to:

```
Filtered H20
                    Prog B000
```

Bank B has now been selected. A further 2 digit entry is required to determine the location of the sound within this Bank if different from the current selection. Press 120 & 3 on the keypad & the display shows:

```
TinCanWire M-Wh
                    Prog B123
```

And the sound has changed.

Pressing the Bank down button once will bring Nova II keyboard back to the A Bank.

Selecting Performances & Favourites is done in exactly the same way.

When sounds are selected from the front panel, the appropriate MIDI Bank & Program change messages are sent on the last entry of the keypad & can be recorded on Computer Software / Sequencer. Selecting sounds via MIDI is very simple, just send the appropriate MIDI Bank number & Program change commands to Nova II keyboard from the Computer Software / Sequencer. To change Programs & Performances, these messages should be sent on the Global MIDI Channel. If however you have a Multitimbral Performance, individual parts can be changed with suitable Bank number & Program change messages on the individual MIDI Channels assigned to the "Parts" of the Performance.

There is a Chart on page 137 outlining all the different Bank numbers for selecting the different modes via MIDI.

SELECTING DRUM MAPS AND DRUM MAP PROGRAMS

Pressing the Program button will activate the Program Mode & the display will show:

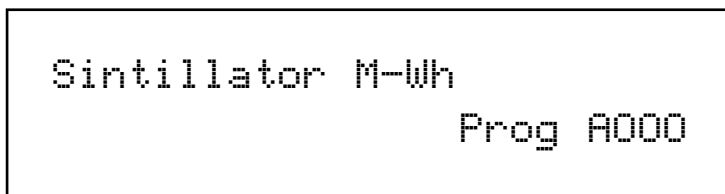

Program mode has been selected because the Program button is lit & the bottom line of the display is indicating "Prog" followed by the Bank & number of the sound. The top line is displaying the name of the sound.

Pressing the Bank up button 4 times & the display changes to:

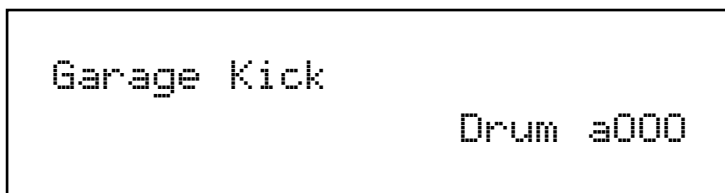

Drum Map a000 has now been selected. A further 2 digit entry is required to determine the location of the sound within this Drum Map if different from the current selection. Press the higher 0 button followed by the lower 2 button on the keypad & the display shows:

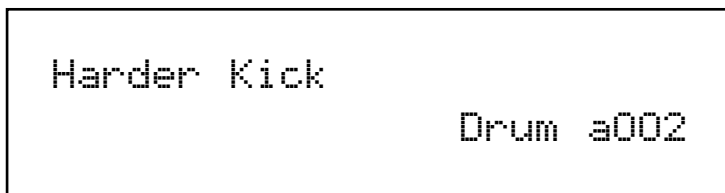

And the sound has changed showing Program a002. Alternatively as all the 50 programs in Drum Map a are simultaneously available on the keyboard, the selection can be made from the keyboard. Play the keyboard until the sound desired is found, now play the note while holding down the Page down button. If D1 is played the display should look the same as above.

When sounds are selected from the front panel, the appropriate MIDI Bank & Program change messages are sent on the last entry of the keypad & can be recorded on Computer Software / Sequencer. Selecting sounds via MIDI is very simple, just send the appropriate MIDI Bank number & Program change commands to Nova II keyboard from the Computer Software / Sequencer. To change Programs & Performances, these messages should be sent on the Global MIDI Channel. If however you have a Multitimbral Performance, individual parts can be changed with suitable Bank number & Program change messages on the individual MIDI Channels assigned to the "Parts" of the Performance.

There is a Chart on page 137 outlining all the different Bank numbers for selecting the different modes via MIDI.

Editing & writing Arpeggio patterns is a bit like "Step" sequencing. It is not immediate & requires understanding of all the parameters necessary to create a Arpeggio pattern that performs how you want. To fully understand this guide it is necessary to have a good understanding of all the standard Arpeggiator's parameters.

The first thing to do is select a Program you want to use with an Arpeggiation. Use the Program, Bank & Keypad to make your selection. Next, turn on the Arpeggiator if not already on with the Arpeggiator On/Off button. Now assign a "User" pattern to the arpeggiator with the "Pattern Bank" Parameter in page 2 of the Arpeggiator Menu button pages. You now have to decide what type of Pattern you wish to create.

There are two basic types of Arpeggio patterns available. These are Monophonic, i.e. a chord is played on the keyboard & single notes are played from that chord sequentially at a speed determined by the "Speed" knob & Polyphonic, i.e. a chord is played on the master keyboard & all the notes are played simultaneously, but may be transposed, at a speed determined by the "Speed" knob. To make a Monophonic pattern select a "User" pattern in page 2 of the Arpeggiator Menu button pages. Select a pattern between 000 & 063 (these are Monophonic) & make a note of the pattern number you have selected. For reasons that become clear below we suggest that for the purposes of learning initially set the "Sync" parameter to a low value. i.e. 8ths & the "Fill In" parameter to "Off". Both of these parameters are on page 5 of the Arpeggiator Menu button pages. Go to the Global Mode by pressing the Global Button. Go to page 7 & switch the Memory Protect parameter to Off. Go to page 18 & select the same pattern you assigned to the Arpeggiator in the Program. You are now ready to start creating a Pattern. The procedures for editing Monophonic & Polyphonic patterns are slightly different.

Monophonic Patterns

A Monophonic pattern can be 1 step long, although there would not be much point in this except for recreating effects like LFO triggered basslines, to 64 steps long. Bear in mind that this can be also thought of as the "Resolution" of the pattern as the pattern can be "Synchronised" at differing time signatures. i.e. a 16 Step pattern synchronised at 16th's would be the same time duration as a 32 step pattern synchronised at 32nds. Decide on the number of steps you want to use & set the "No of Steps" parameter on page 18 of the global mode to suit. We suggest that for the purposes of learning initially set this to a low value. i.e. 8, this will mean that The Arpeggiator is synchronised to 8ths & the Number of steps you have assigned to the Pattern is 8. So this is a 1 bar pattern.

In a Monophonic pattern you decide which "Order" the individual "notes" within the "chord" you play are played. Imagine you are playing the notes shown below:

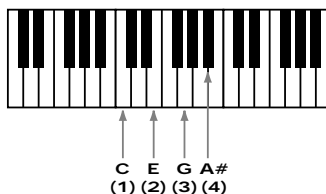

There are 4 notes being played C, E, G & A# creating a C 7 Chord. Nova II keyboard scans the keyboard & "labels" each of the played notes with a note number, starting with the lowest (if the "Fill in" parameter is set to "Off-Up" or "On-Up") . In this case C = 1, E = 2, G = 3 & A# = 4. If a D was played instead of the E the numbering would be as follows C = 1, D = 2, G = 3 & A# = 4. If a D was played instead of the C the numbering would be as follows D = 1, E = 2, G = 3 & A# = 4. It is important to understand this relationship to understand the next step.

As you remember there are 8 steps in the assigned pattern. You can edit each step individually by selecting the step you wish to edit with the "Step" parameter on Page 19 of the Global mode & similarly altering the "Note" number assigned to that step on the same page with the "Note" parameter.



A "Gate" of "Norm" or "Glide" must be assigned to the currently selected step on this page for the "Note" parameter on this page to become available.

For example to create a simple Up/Down pattern program the following:

Step 1 = Note 1, Step 2 = Note 2, Step 3 = Note 3, Step 4 = Note 4, Step 5 = Note 4, Step 6 = Note 3, Step 7 = Note 2, Step 8 = Note 1. The sequence of notes played is 1,2,3,4,4,3,2,1 etc. etc.



If more or less notes are played than you have programmed, the pattern will not play as expected. In the above example if 6 notes were played the 5th & 6th notes played would not sound. In the above example if 2 notes were played the following would occur:

Step 1 = Note 1, Step 2 = Note 2, Step 3 = Note 2, Step 4 = Note 2, Step 5 = Note 2, Step 6 = Note 2, Step 7 = Note 2, Step 8 = Note 1.

The sequence of notes played is 1,2,2,2,2,2,1 etc. etc. This is why the "Fill In" parameter is there. It should be currently in the

EDITING & WRITING ARPEGGIATOR PATTERNS

"Off" position. In this position you can program your patterns more efficiently but for the best results when played, it should be set to "On". In this position the missing notes are inserted by the Arpeggiator so that larger or less numbers of notes than are programmed into the pattern are used.



NOTE:

In Monophonic patterns there is a limit of 12 different note values that can be programmed into a pattern.

Of course much more interesting sequences are possible. i.e.

Step 1 = Note 4, Step 2 = Note 1, Step 3 = Note 3, Step 4 = Note 2, Step 5 = Note 3, Step 6 = Note 2, Step 7 = Note 1, Step 8 = Note 4.

This produces the sequence of notes 4, 1, 3, 2, 3, 2, 1, 4 etc. etc. A kind of inside-out Up/Down sequence of notes. When you consider that there are 64 steps available it can be seen that there are many things possible. There are 2 other parameters associated with programming Monophonic patterns. On page 19 of Global you can also assign velocity values for each of the steps & on the same page Gate type can be assigned for each step of the pattern. When the "Gate" parameter is set to "Normal" the setting of the "Gate" knob applies. When the "Gate" parameter is set to "Tie" the note is "Tied" to the note in the previous step. This allows syncopated rhythms to be created & can be used to great effect if the pattern is set to have many steps. When the "Gate" parameter is set to "Rest" no note is played on the selected step & finally when the "Gate" parameter is set to "Glide" the Portamento is engaged when the selected step switches to the next step & then the Portamento is switched off. This is great for creating those TB303 type patterns with slides.



NOTE:

Glide will only work when the polyphony of the Program / Part is set to Mono.

Patterns do not have to be entered in step time. Patterns can be entered in via the keyboard. Note & Velocity settings for each step can be easily entered using the keyboard & using a sustain pedal also allows gate characteristics to be entered. Refer to the "Arp pattern editing via kbd" Parameter on page 17 of the Global menu for details.



NOTE:

The Constant pitch parameter does not apply to Monophonic patterns & in this mode will do nothing if set to On or Off.

Polyphonic patterns

To make a Polyphonic pattern select a "User" pattern on page 2 of the Arpeggiator Menu button pages. Select a pattern between 064 & 127 (these are Polyphonic) & make a note of the pattern number you have selected. Polyphonic patterns differ in the sense that all the notes played sound at once. Initially this can be thought of as a kind of "Gater". Instead is assigning which "Note" out of the ones you are playing will be played at each step in the pattern, in a Polyphonic pattern all the notes may be transposed at each step by a definable amount. Here is an example, the notes being played are shown below:

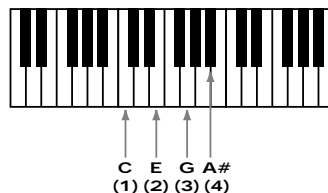

This is a C7 chord. Below is an example Polyphonic Pattern, again of 8 steps in length:

Step 1 = Note 0, Step 2 = Note 2, Step 3 = Note -2, Step 4 = Note 0, Step 5 = Note 0, Step 6 = Note 12, Step 7 = Note -12, Step 8 = Note 0.

This results in a chord sequence of C7, D7, A#7, C7, C7, C7 (one octave up), C7 (one octave below), C7. etc. etc.



NOTE:

In Polyphonic patterns there is a limit of -36 to +36 semitones range that can be programmed into a pattern.

Negative as well as positive values can be entered into the "Note" parameter in polyphonic patterns. Again when you consider that there are 64 steps available in a pattern there are many things possible. Like the Monophonic patterns, there are 2 other parameters associated with programming Polyphonic patterns. They perform the same functions in Polyphonic patterns or Monophonic patterns. On page 19 of Global you can assign velocity values for each of the steps & on the same page the Gate time can be assigned for each step of the pattern. When the "Gate" parameter is set to "Normal" the setting of the "Gate" knob applies. When the "Gate" parameter is set to "Tie" the note is "Tied" to the note in the previous step. This allows syncopated rhythms to be created & can be used to great effect if the pattern is set to have many steps. When the "Gate" parameter is set to "Rest" no note is played on the selected step & finally when the "Gate" parameter is set to "Glide" the Portamento is engaged when the selected

step switches to the next step & then the Portamento is switched off. This is great for creating those TB303 type patterns with slides.



NOTE:

The "Fill In" parameter does not apply for Polyphonic patterns & does nothing if switched "On" or "Off".



NOTE:

Glide will only work when the polyphony of the Program / Part is set to Mono.

Several Monophonic & Polyphonic patterns can be used at once in a Performance. One doing a Bass type Pattern, One doing a TB303 thing, One doing a "Classic" Up/Down thing etc. etc. It is even possible to have the Arpeggiators in the different programs synchronised to different time signatures. When doing this turning the "Speed" knob will alter the speed of all the arpeggiators, in other words it is not possible to have arpeggiators running on different clock speeds, if you wish the arpeggiators to run at differing speeds set the "Sync" parameter in the Arpeggiators to differing values.

EDITING & WRITING PROGRAMS

Editing Programs is easy on the Nova II keyboard as virtually all the controls needed to create a sound are on the front panel. First make sure that Nova II keyboard is in the Program mode. The Program button should be lit. Now it is just a case of adjusting the knobs & buttons in the Oscillator, Filter, LFOs, Envelopes, Arpeggiator & Effects Sections until the desired sound is created. Notice that the display changes to display the name of the rotary control you are currently editing. The display will remain displaying this parameter after you stopped adjusting the rotary control (unless currently in a "Menu"). The display shows the first rotary to be adjusted, of course many rotary controls can be adjusted at once but the display only shows the last.



NOTE:

Writing Programs is a destructive operation. It is strongly advised to make back-ups of your data occasionally to a Computer, Sequencer or Data filing device. Factory sounds in Program banks A,B,C & D can be recalled from ROM see page 52 for details on how to do this.

Once a sound has been created it may be stored in any of the 4 banks of 128 Programs. To do so press the Write button. The display shows:

```
Write Prog A000 to A000?  
Sintillator M-Wh
```

The top line of the display shows the current Program location & the Programs destination. The bottom line displays the Programs name, in this case Sintillator M-Wh.

While in this mode it is possible to change the destination of the new sound using the bank & the keypad buttons or the upper Data knob. For example, pressing the Bank button in the above example, the display will show:

```
Write Prog A000 to B000?  
Filtered H20
```

Bank B has now been selected. A further 2 digit entry is required to determine the location of the sound within this Bank if different from the current selection. Press 120 & 3 on the keypad & the display shows:

```
Write Prog A000 to B123?  
TinCanWire M-Wh
```

The destination of the sound to be written is now B Bank number 123.



NOTE:

While in this mode the Compare button has a different function to its normal operation. The Compare button in this mode toggles between the currently edited sound & the destination Program. The "Program" button will flash when this function is active.

Once the destination for the Program has been decided press the Write button again & the display shows:

```
Name Prog B002  
'TinCanWire M-Wh '
```

The name of the Program can be altered when in this mode. In the display the first character of the Programs name has a cursor under it. Using the higher Data knob you can scroll through the character set for that character. Using the lower Data knob you can move the cursor horizontally.



NOTE:

Pressing the Page Up button while in this mode inserts a space at the cursor position & pressing Page Down while in this mode deletes the character at the cursor. The Keypad & Bank buttons also provide useful shortcuts when in this mode. Pressing the keyboard buttons with or without the 2 bank buttons perform several functions. These are as follows.

Top Row
a b c d e f g h I j k l m

Top Row + Bank Up button (momentary action)
n o p q r s t u v w x y z

Top Row + Bank Down button (latched action)
A B C D E F G H I J K L M

Top Row + Bank Up & Down buttons together
N O P Q R S T U V W X Y Z

Bottom Row
0 1 2 3 4 5 6 7 8 9

Bottom Row + Bank Up button (momentary action)
Space . - # () [] ! *

Bottom Row + Bank Down button (latched action)
[Current word 1st] [Current word Last] [Previous word 1st] [Next word 1st] [Previous word last]
[Next word last] [Previous space] [Next space] [1st char] [Last char]

Bottom Row + Bank Up & Down buttons together
[Toggle case char] [Char upper case] [Char lower case] [All words lower case with Upper case first letter] [All words upper case]
[All words lower case] [Rotate text left] [Rotate text right] [Clear text] [Restore text]

Once the name has been selected, press write again & the display shows:

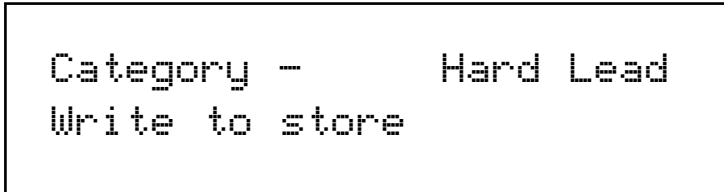

The Nova II keyboard is asking confirmation that you wish to write over the destination Program, replacing it with the newly edited sound. Also on the top line of the display it can be seen that there is the category parameter. This is where you set the category of the Program so that the "Finder" mode can locate programs with the same category assigned. To adjust this parameter, use the higher Data knob. There are 20 categories. Refer to page 47 for details on the categories.

To complete the operation, press the Write button to confirm & the display shows:

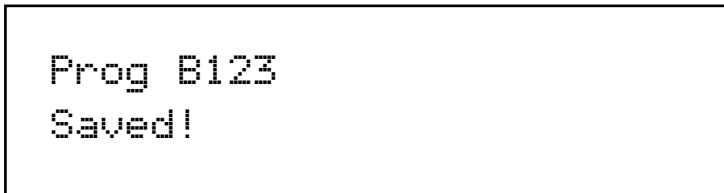

This will stay on the screen for several seconds then revert back to the standard Program page.

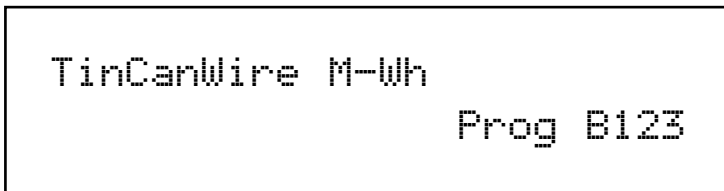



NOTE:

At any stage during the write procedure pressing the Program button will exit the write procedure & return the Display to showing the Program name & location.



NOTE:

The current selection of Oscillator, LFO & ENV2 or 3 plus the selection of Mod Sources & Mod Destinations in the Oscillator & Filter sections are memorised when the sound is written into memory. This allows any setup to be recalled when the program is recalled which can be very useful in live performance.

Editing Drum Map Programs is almost the same as editing normal Programs. There is one extra Drum Map parameter that only available in Program mode. It is possible to define the pitch the Program will play at when it is in a Drum Map. To do this, select Program mode (Program button is lit) & access the desired Drum Map with the bank buttons. For example if Drum map a was selected the display should show:

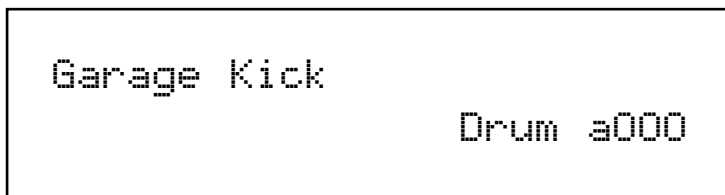

While in this mode, press the Tune button in the Part edit section & the display will show:

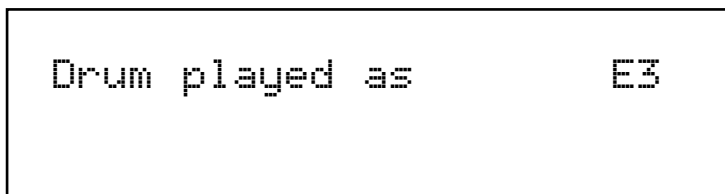

The parameter is "Drum played as" with a value of E3.

This parameter determines the note the Drum Program will be pitched at. This is not the note on the keyboard that the Drum Program is triggered from, (this is not assignable) but it is the pitch of the Program. This can be set with the higher Data knob or directly using the keyboard. To do this simply play the desired note on the keyboard while holding down the Page up button when this display is showing & the appropriate note value will automatically be inserted for the currently selected Program. The range of this parameter is C-2 to G8. This parameter is memorised with a Program.

Writing of Drum Map Programs into memory is done in exactly the same way as Programs. Programs can be freely written into Drum Map Programs & visa versa.



NOTE:

This parameter only takes effect when the program is situated within a Drum Map.

Editing Performances is very easy. After Pressing the Performance button the button lights & the Display shows:

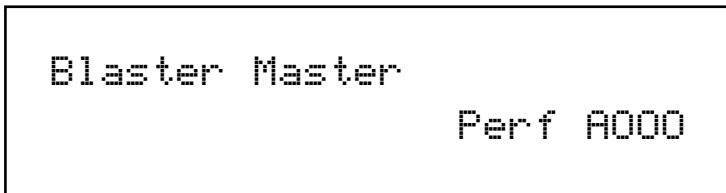

Performances are made up of 6 Parts. The next thing to do is select the "Part" of the Performance you wish to edit. To do this press the appropriate Part button in the Part edit section. In the above example pressing Part 1 button the display will show:

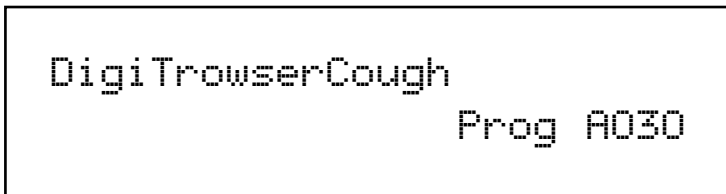

The display is showing the Program currently assigned to the selected Part. Any Program from any one of the Program Banks can be assigned to any Part of a Performance. You can use the Bank button & the keypad buttons to alter the Program assigned to this Part of the Performance.

When in this mode, pressing the Tune, Velocity, Output, MIDI, Polyphony & Range buttons will display the relative parameters for the currently selected Part. If any of the Tune, Velocity, Output, MIDI, Polyphony & Range buttons are pressed it will flash indicating that it has been selected. This allows easy comparison of values in different Parts. For example, press the MIDI button after Part 1 of a Performance has been selected & the display will show:



The MIDI button is flashing indicating it is selected. Pressing another Part button will light the selected button & the display will show the MIDI parameters for the newly selected Part as shown below.

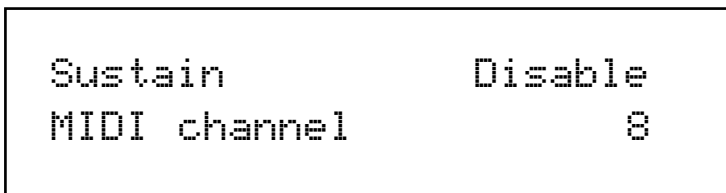

To exit any of the Tune, Velocity, Output, MIDI, Polyphony & Range Menus, simply press the Performance button again & the display will change back to showing the currently selected Performance as shown below:

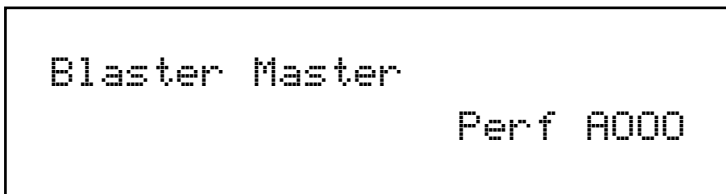

Alternatively, pressing the flashing Part button will return the display to the Performance (If no part button had been selected) or the display will show the Program assigned to the currently selected part. (If a Part button had been selected)

For details on the parameters in the "Tune", "Velocity", "Output", "MIDI", "Polyphony", & "Range" menus refer to the "Part Edit Section" of this manual on page 121.



NOTE:

Pressing any of the Part buttons when in Performance mode not only makes the display show the Program name & location but also brings the selected Part up on the front panel controls. This allows editing of Programs while in Performance mode. All the

EDITING & WRITING PERFORMANCES

edits made are transmitted as Controllers & NRPNs on the MIDI channel assigned to the Part of the Performance, so in a Multitimbral Performance each Part can be individually edited, recorded on a sequencer & played back into the Nova II keyboard.



NOTE:

At any stage during editing a Performance, pressing the Performance button will exit the "Part" display & return the Display to showing the Performance name & location.

It is possible to temporarily "Mute" Parts of a performance allowing the easy auditioning of separate parts of a Performance whilst editing or during live performance in a Multitimbral Performance. This is done by simply pressing the Mute button (the Mute button will light indication that the Mute mode is active) & pressing the Part button that you want muted. The muted Part button will flash indicating that it is muted. The display will change to:

```
DigiTrowserCough
(Muted)           Perf A000
```

The part is Muted. Pressing the Part button again while the Mute mode is active will un-mute the Part & the Part button will stop flashing & remain lit. The display will change to:

```
DigiTrowserCough
Part un-muted
```

The part is now re-activated. The display remains like this for a few moments & then returns to:

```
DigiTrowserCough
Prog A030
```

The status of the mutes applied to each part of a performance is memorised with a Performance. This is handy for live applications as a complete setup is stored complete with mutes. For example 7 Parts of a Performance can be memorised with Mutes on, leaving 1 Part active which is playing say a Bassline. Simply pressing the mute button & un-muting/muting Parts while the sequencer is playing makes it easy to realise Breakdowns & Builds during live performance.

Similarly there is a Solo function for auditioning sounds. This is done by simply pressing the Solo button (the Solo button will light indication that the Solo mode is active) & pressing the Part button that you want soloed. The Solo part button will light indicating that it is soloed & all the other part buttons will flash indicating that they are muted. The display will temporarily change to:

```
DigiTrowserCough
Part soloed
```

The part is Soloed. Pressing any other part button will similarly Solo that Part. Only one part can be soloed at one time. To exit the Solo mode simply press the Solo button so it is unlit.



NOTE:

To assign no Program to a Part (Off) press set the Polyphony Parameter in the Polyphony button menu to "Off".



NOTE:

Only one Performance can be used at any one time. Performances cannot be used as Parts of other Performances & you cannot assign different Performances to different MIDI channels & expect to get Multiple Performances.



NOTE:

When Performance mode is entered, whatever Part happened to be selected when the Performance was saved is now selected. To adjust the Program assigned to any Part, for example Part 1, press Part 1 button even if it is already lit. It will stay lit & the display will change from showing the Performance Bank, Number & Name to displaying the Part, Program, Number & name. To return to the Performance Bank, Number & Name press the Performance button.



NOTE:

Writing Performances is a destructive operation. It is strongly advised to make back-ups of your data occasionally to a Computer, Sequencer or Data filing device. Factory sounds in Performance banks A & B can be recalled from ROM see page 52 for details

Once a Performance has been created, you can store the Performance in any of the 512 Performances. To do so press the Write button. The display shows:

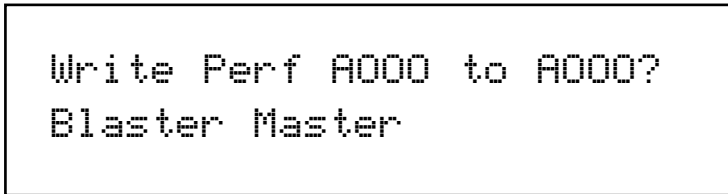

The top line of the display shows the current Performance location & the Performance's destination. The bottom line displays the Performance's name, in this case Blaster Master!

While in this mode, it is possible to change the destination of the new sound using the Bank & Keypad buttons. For example, pressing 001 on the keypad in the above example & the display will show:

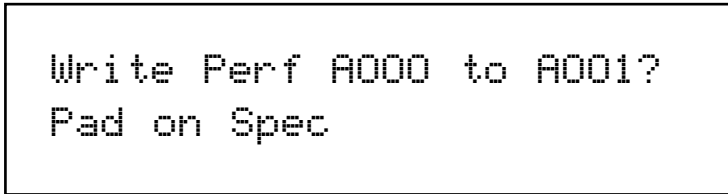

The destination of the Performance to be written is now A001.



NOTE:

In this mode, the Compare button has a different function to its normal operation. The Compare button in this mode toggles between the currently edited Performance & the destination Performance. The "Performance" button will flash when this function is active.

Once the destination for the Performance has been decided press the Write button again & the display shows:

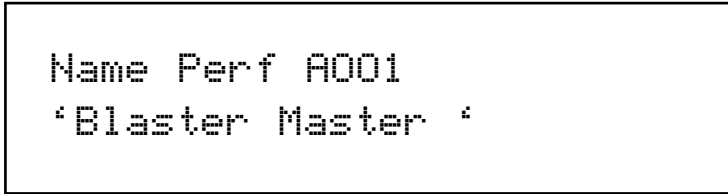

The name of the Performance can be altered when in this mode. In the display the first character of the Performances name has a cursor under it. Using the higher Data knob you can scroll through the character set for that character. Using the lower Data knob you can move the cursor horizontally.

EDITING & WRITING PERFORMANCES



NOTE:

Pressing the Page Up button while in this mode inserts a space at the cursor position & pressing Page Down while in this mode deletes the character at the cursor. The Keypad & Bank buttons also provide useful shortcuts when in this mode. Pressing the keyboard buttons with or without the 2 bank buttons perform several functions. These are as follows.

Top Row

a b c d e f g h i j k l m

Top Row + Bank Up button (momentary action)

n o p q r s t u v w x y z

Top Row + Bank Down button (latched action)

A B C D E F G H I J K L M

Top Row + Bank Up & Down buttons together

N O P Q R S T U V W X Y Z

Bottom Row

0 1 2 3 4 5 6 7 8 9

Bottom Row + Bank Up button (momentary action)

Space . - # () [] ! *

Bottom Row + Bank Down button (latched action)

[Current word 1st] [Current word Last] [Previous word 1st] [Next word 1st] [Previous word last]
[Next word last] [Previous space] [Next space] [1st char] [Last char]

Bottom Row + Bank Up & Down buttons together

[Toggle case char] [Char upper case] [Char lower case] [All words lower case with Upper case first letter] [All words upper case]
[All words lower case] [Rotate text left] [Rotate text right] [Clear text] [Restore text]

Once the name has been selected, press write again & the display shows:

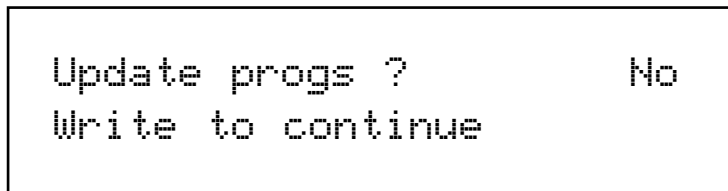

The Nova II keyboard is asking confirmation that you wish to write over the destination Performance, replacing it with the newly edited Performance. On the top line of the display Nova II keyboard is asking if you wish to update (re-write) all the Programs used in the currently selected Performance. If this parameter is set to "No" then the Performance only is written into memory. If this parameter is set to "Yes" then any alterations made to the Programs (excluding the over-rides such as Part Volume, Arp On/Off & Effects settings if the Parts Effects used parameter in the Output menu is set to Part) will be written into all the Programs used in the selected Performance. If this parameter is set to "Each" then any alterations made to the Programs (excluding the over-rides such as Part Volume, Arp On/Off & Effects settings if the Part Effect parameter is set to Part i.e. lit) can be selectively saved one by one. Nova II keyboard asks for confirmation to save each Part individually, showing the Part number & the Program number. Individual Parts can be left unsaved (Skipped) by turning the lower Data knob while in this mode.



NOTE:

When in this mode the Compare button toggles between the destination Program & the edited Program. Both the Performance & the Program buttons will flash when the Compare mode is active.

To complete the operation press the Write button to confirm & the display shows:

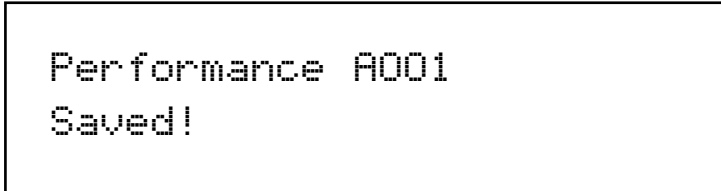

This will stay on the screen for several seconds then revert back to the standard Performance page.



NOTE:

At any stage during the write procedure pressing the Performance button will exit the write procedure & return the Display to showing the Performance name & location.

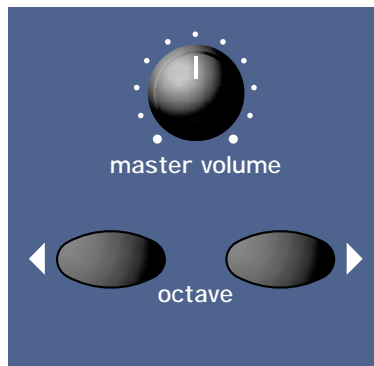

Volume - Knob

This knob adjusts the overall output of the Nova II keyboard on the Left & Right outputs.



NOTE:

This can be overridden by MIDI Controller Data. If a MIDI Controller 97 with a value of "0" has been received by the Nova II keyboard, no output will be heard regardless of the position of this knob. To reset the volume either transmit the relevant MIDI Volume level or move the Volume knob. (This automatically overrides the MIDI setting.)



NOTE:

The volumes of each "Part" in a Performance can be set individually using the Part select buttons & the Level knob in the Part Edit Section.

Octave - Buttons

These buttons change the octave which the Keyboard plays. If both buttons are not lit, then the transposition is normal (i.e. C1 to C6)

Pressing the Octave > button transposes the Keyboard up one octave (i.e. C2 to C7) & the button will light indicating a transposition has been made. The < Octave button works in a similar way but transposes down an octave. Successive presses of these buttons produce more shifts in transposition. The maximum range of transposition possible is +/- 3 octaves.



NOTE:

If either of the octave buttons are lit, (octave transposition up or down is active) the normal transposition of C2 to C7 can be recalled by pressing both the Octave buttons at the same time.

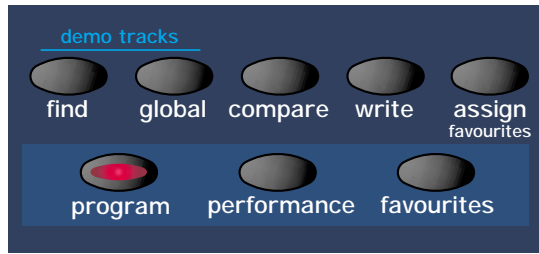

This is where you select the various operating modes of the Nova II keyboard, initiate the Finder function, edit Global parameters Compare & Write Performances & Programs, assign Programs & Performances to the Favourites map, select Program, Performance & Favourites Modes, & play the Factory Demo.

Find - Button

With so many sounds it can be a little difficult to find your favourite sounds quickly. For this reason Nova II keyboard features a "Finder" mode that can find similar types of sounds. Nova II keyboard has 20 "Categories" of sounds. They are as follows:

1	Bass	9	Pad	17	User 1
2	Hard Bass	10	Strings	18	User 2
3	Soft Lead	11	Keyboard	19	User 3
4	Hard Lead	12	SFX	20	User 4
5	Porta Lead	13	Drums		
6	Arpeggio	14	Piano		
7	Motion	15	Organ		
8	Bell	16	Brass		

Each Performance & Program in Nova II keyboard has a "Category" assigned to it. The Finder uses categories to find similar sounds. To use the Finder, press the Find button. (a small sequence suitable for the selected sound category will play if the "Finder demos" parameter on page 14 of the global mode is set to On) When the Find button is pressed the display shows:

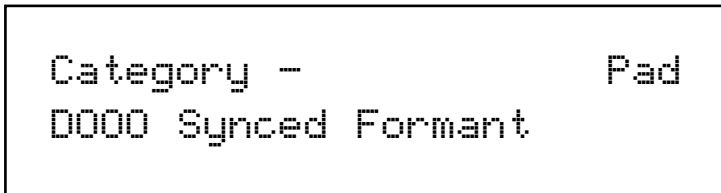

The higher parameter is "Category". In this case with a value of Pad. This parameter determines which category of sound you wish to find. Use the upper Data knob to adjust the value of this parameter. The range of this parameter is Bass, Hard Bass, Soft Lead, Hard Lead, Porta Lead, Arpeggio, Motion, Bell, Pad, Strings, Keyboard, SFX, Drums, Pianos, Organ, Brass & User 1 to User 4.

The lower parameter is a Program in the selected category. In this case with a value of D000 Synced Formant. Use the lower Data knob to select the sounds.

To return to normal operation press the Program or Performance button.

Compare - Button

This button is used to activate the Compare function. When editing a Program, it is often convenient to monitor the original in comparison to the newly modified version. This is called the compare function. To enable this feature simply press & hold down the Compare button. As soon as the button is released, the modified version of the Program will once again be available.



NOTE:

While the Compare button is held, it is also possible to inspect any of the original programs knob parameters - simply adjust any knob while the Compare button is being held. The display will show for a short while the value of the original programs setting then revert back to the last edited parameter. No knob parameter can actually be altered while the Compare button is held.



If you wish to inspect the value of a modified Program knob parameter (rather than the original Program), simply follow the above procedure, & once you have finished turning the relevant knob, release the Compare button quickly before the temporary display disappears. As soon as the Compare button is released, the temporary display will revert to showing the current modified programs parameter rather than the original programs parameter



In the "Write" phase, the Compare button performs a different function to its normal operation. The Compare button in this mode toggles between the currently edited Performance or Program & the destination Performance or Program. When the destination Program or Performance is selected, the Program and/or Performance buttons will flash & the Compare button will be lit indicating that the sound currently being produced by the Nova II keyboard is the original still stored in memory.

Global - Button

The Global Mode has all the parameters that affect the "Global" operation of Nova II keyboard. This mode is accessed by pressing the Global button.



When any Global data is written into memory, the currently selected Program or Performance will become the "Power Up" sound. i.e. the sound the Nova II keyboard defaults to when switched on.

When this button is pressed a series of pages is available on the display containing parameters relevant to this section. In the Global Mode there are 16 pages available. These are selected using the Page Up & Page Down buttons to the left of the display.

There are a maximum of 2 parameters displayed on any page. One for each line on the display. The upper & lower Data knobs on the right of the display are used to alter these parameter's values.

Page 1 looks like so:

Master tune	+00
Global MIDI chan	1

The higher parameter is "Master tune". In this case with a value of +00. This parameter determines Global tuning of Nova II keyboard. Use the upper Data knob to adjust this parameter. The range of this parameter is -64 to +63 cents. This parameter is memorised as Global.



To write any changes to this parameter into memory press the "Write" button while in this mode. Also note the "Memory Protect" has to be set to "Off" for this to be possible.

The lower parameter is "Global MIDI chan". In this case with a value of 1. This parameter determines the Global MIDI Channel for the Nova II keyboard. This Channel is used when in Program Mode & for transmission & reception of Sysex data. Use the lower Data knob to adjust this parameter. The range of this parameter is 1 to 16. This parameter is memorised as Global.



To write any changes to this parameter into memory press the "Write" button while in this mode. Also note the "Memory Protect" has to be set to "Off" for this to be possible.

Page 2 looks like so:

```
Sysex transmission -
      Single program
```

The higher parameter is "Sysex transmission". In this case with a value of Single Program.

This parameter selects the type of data to be dumped via MIDI. Use the lower Data knob to adjust this parameter. Whatever value is set on the lower line of the display is transmitted when the MIDI button is pressed in the Part edit section. The range of this parameter is Single program, All programs, Single prog request, All progs request, Single performance, All performances, Single perf request, All perfs request, Single arp pattern, All arp patterns, Single patt request, all patts request, Global parameters, Globals request, Program bank A, Program bank B, Program bank C, Program bank D, Program bank E, Program bank F, Program bank G, Program bank H, Program bank A request, Program bank B request, Program bank.C request, Program bank D request, Program bank E request, Program bank F request, Program bank G request, Program bank H, Performance bank A, Performance bank B, Performance bank C & Performance bank D, Performance bank A request, Performance bank B request, Performance bank C request, Performance bank D request, Drum map a, Drum map b, Drum map c, Drum map d, Drum map e, Drum map f, Drum map g, Drum map h, Drum map a request, Drum map b request, Drum map c request, Drum map d request, Drum map e request, Drum map f request, Drum map g request, Drum map h request, Total data & Total data request. This parameter is memorised as Global.

**NOTE:**

The Nova II keyboard can accept System Exclusive dumps while in any mode.

**NOTE:**

To write any changes to this parameter into memory press the "Write" button while in this mode. Also note the "Memory Protect" has to be set to "Off" for this to be possible.

Page 3 looks like so:

```
Sysex reception -
      Normal (RX as sent)
```

The higher parameter is "Sysex Reception". In this case with a value of Normal (Rx as sent).

This parameter determines if incoming Sysex data will be received & if it is a bank dump, which bank it will be written in. Use the lower Data knob to adjust this parameter. If this parameter is set to "Normal (Rx as sent)" the system exclusive is enabled & any incoming bank dumps will be stored in the same location as they were sent. i.e. a Prog bank A dump will be written to Prog bank A. If this parameter is set to "All progs to bank A", any incoming Program bank dump will be written into Program bank A regardless of its original location when transmitted. If this parameter is set to "All perfs to bank A", any incoming Performance bank dump will be written into Performance bank A regardless of its original location. If this parameter is set to "Disabled" no sysex messages will be recognised. The range of this parameter is Disabled, Normal (Rx as sent), All progs to bank A, All progs to bank B, All progs to bank C, All progs to bank D, All progs to bank E, All progs to bank F, All progs to bank G, All progs to bank H, All progs to Dmap a, All progs to Dmap b, All progs to Dmap c, All progs to Dmap d, All progs to Dmap e, All progs to Dmap f, All progs to Dmap g, All progs to Dmap h, All perfs to bank A, All perfs to bank B, All perfs to bank C & All perfs to bank D. This parameter is memorised as Global.

**NOTE:**

To write any changes to this parameter into memory press the "Write" button while in this mode. Also note the "Memory Protect" has to be set to "Off" for this to be possible.

Page 4 looks like so:

MIDI clock	Int
Pedal/breath control	Off

The higher parameter is "MIDI clock". In this case with a value of Int. This parameter determines if the Nova II keyboard is syncing to Internal or External MIDI Clock. Use the upper Data knob to adjust this parameter. The range of this parameter is On & Off. This parameter is memorised as Global.



To write any changes to this parameter into memory press the "Write" button while in this mode. Also note the "Memory Protect" has to be set to "Off" for this to be possible.

The lower parameter is "Pedal/breath control". In this case with a value of Off. This parameter determines if the Nova II keyboard re-maps incoming Pedal data & Breath Control MIDI data (CC no 2) into Mod wheel data (CC no 1), Aftertouch data or any controller from 3 to 119 & Pitchbend data . Use the lower Data knob to adjust this parameter. This allows incoming Pedal & Breath Control data to manipulate most of Nova II keyboard's key parameters directly. The range of this parameter is Off, MW, A/T, CC3 to 119, Bend, Bend+, Bend-, NRPN75 to NRPN77, NRPN95 and NRPN96. This parameter is memorised as Global.



To write any changes to this parameter into memory press the "Write" button while in this mode. Also note the "Memory Protect" has to be set to "Off" for this to be possible.

Page 5 looks like so:

Breath mode	Absolute
Breath sensing	Norm

The higher parameter is "Breath mode". In this case with a value of Absolute. This parameter determines how incoming Breath controller information is interpreted by Nova II keyboard. Use the upper Data knob to adjust this parameter. If this is set to Absolute then the destination (the parameter assigned with the "Breath control" parameter on Page 6 of global mode) will be modulated directly regardless of its setting in the currently assigned program. If this parameter is set to Mod+ then the breath control value would be added to the value of the destination in the currently loaded program. If this parameter is set to Mod- then the breath control value would be subtracted from the value of the destination in the currently loaded program. i.e. If the destination was Cutoff Frequency & the currently assigned programs Cutoff Frequency was assigned to a level of 64, in Absolute mode when a breath control message with a value of 1 was received the Cutoff Frequency would change to 65. If in this case this parameter was set to Mod+ the value of the Cutoff Frequency would be 65 & if in this case this parameter was set to Mod- the value of the Cutoff Frequency would be 63. The range of this parameter is Absolute, Mod+ and Mod-. This parameter is memorised as Global.



To write any changes to this parameter into memory press the "Write" button while in this mode. Also note the "Memory Protect" has to be set to "Off" for this to be possible.

The lower parameter is "Breath sensing". In this case with a value of Norm. This parameter determines how sensitive Nova II keyboard is to incoming breath controller messages. Incoming Breath control messages can be dealt with as they are when this parameter is set to normal. If this parameter is set to a negative number (-3 for example) incoming breath control messages are scaled down. Alternatively, incoming breath control messages can be exaggerated or amplified by setting this parameter to a positive number (+3 for example). Use the lower Data knob to adjust this parameter. The range of this parameter is -5 to -1, Norm & +1 to +5. This parameter is memorised as Global.

Page 6 looks like so:

Arp trans chan	Kbd
Arp trans ref	C3

The higher parameter is "Arp trans chan" (Arpeggiator real-time transpose channel), in this example with a value of Kbd. Use the upper Data knob to adjust this parameter. This parameter is used to specify a MIDI channel which can be used to transpose all Arpeggiators in real-time. When this parameter is set to Kbd, only the real-time transpose zone on the keyboard (active when the Real Time Transpose button is lit) can be used for this purpose. When this parameter contains the value 1 to 16, note information on an external MIDI channel can also be used for real-time transposition. The real-time transpose zone on the keyboard (active when the Real Time Transpose button is lit) may still be used to transpose Arpeggiators, in which case the corresponding Note information is transmitted via MIDI using the specified Arpeggiator real-time transpose channel. The range of this parameter is Kbd, 1 to 16. This parameter is memorised with the global parameters.

The amount of transposition applied to an Arpeggiator corresponds to the difference in semitones between the note played & the note defined by the "Arp Transpose Reference Note" (also set in the Global Menu – see below). The transposition can be negative as well as positive. For example, if the "Arp Transpose Reference Note" is defined as note C3, playing C#3 will result in the whole arpeggio being transposed up one semitone from its original key. If Bb3 is played, the whole arpeggio will now be transposed down two semitones from its original key & so on. To return the arpeggio to its original key (a transposition of zero semitones), it is necessary to play the same note value as defined by the "Arp Transpose Reference Note".

The lower parameter is "Arp trans ref" (Arp transpose reference note), in this example with a value of C3. Use the lower Data knob to adjust this parameter. This parameter determines the reference note as described above for the real-time Arpeggio transpose function. The range of this parameter is C-2 to G8. This parameter is memorised with the global parameters.



NOTE:

An Arpeggio must have its Real-time transpose parameter (set in the Arpeggiator Menu) set to On for real-time transposition to take effect.



NOTE:

Whenever realtime transpose note data is received via MIDI or generated from the keyboard, the Transpose Zone button will blink briefly.



NOTE:

To write any changes to this parameter into memory press the "Write" button while in this mode. Also note the "Memory Protect" has to be set to "Off" for this to be possible.

Page 7 looks like so:

Local control	On
Memory protect	Off

The higher parameter is "Local Control". In this case with a value of On.

This parameter is normally set to On. With this setting, any knob movements or button presses on the front panel are transmitted via MIDI & also control the synth engine directly. i.e. turning a knob will alter the sound produced regardless of any MIDI setup. If this parameter is set to Off, knob movements & button presses on the front panel still transmit MIDI data but make no alteration to the sound. This is the best way to use the Nova II keyboard with a sequencer as all the Channel re - mapping features in sequencers can be taken fully advantage of. This parameter is memorised as Global.



If there is no MIDI feedback loop connected at all (a sequencer with MIDI out of the Nova II keyboard connected to MIDI in on the sequencer & MIDI out of the sequencer connected to MIDI in on the Nova II keyboard for example) & local control is set to off, the knobs & buttons on the front panel will appear to do nothing although changing parameters values may be displayed on the display.



When changing Programs, Performances or Favourites with the Local off & no MIDI loop present the display will indicate any change made on the keypad section but will not change the name of the sound. This is because the Nova II keyboard is indicating that a change has been transmitted with the numbers but this message has not been received & therefore the sound & it's name has not changed.



If local control is set to off, When Parts are muted or soloed in Performance mode, flashing Part buttons will indicate the MIDI information transmitted, not necessarily relevant to each Parts current mute status.

The lower parameter is "Memory protect". In this case with a value of Off.

This parameter determines if the memory can be written to or not. Use the lower Data knob to adjust this parameter. In the "On" position, Programs, Performances, Patterns or Global Data cannot be written into memory. In the "Off" position, Programs, Performances, Patterns or Global Data can be written into memory. This parameter is memorised as Global.

Page 8 looks like so:

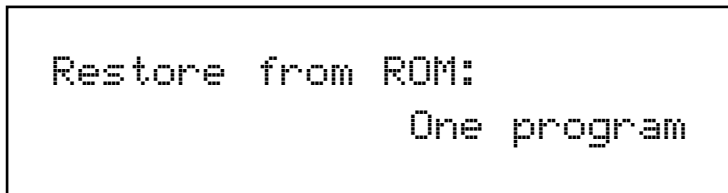

Pressing the Write button while this page is displayed starts the Restore procedure.

The parameter is "Restore from ROM:". In this case with a value of One program.

This parameter allows the factory Programs, Performances & Global data & Arp Pattern data to be restored to the Factory settings. Use the lower Data knob to adjust this parameter. Whatever selection is made with the lower Data knob is restored into memory (ERASING WHAT WAS THERE!!) when the "Write" button is pressed while in this mode. Additional pages appear depending on the selection. i.e. if "All data" is selected Nova II keyboard asks for confirmation which is set with the lower Data knob, if you set this to "Yes" & press the "Write" button again all the factory setting will be restored. If however "One prog" was selected Nova II keyboard asks which Program you want to restore, which is selected using the lower Data knob, & then pressing the "Write" button again Nova II keyboard asks for the location (Program bank & number) that you wish to store the program in. The range of this parameter is One prog, One perf, One patt, All progs, All perfs, All patts, Globals, Favourites, All data, Prog bank A, Prog bank B, Prog bank C, Prog bank D, Perf bank A, Perf bank B, Dmap a, Dmap b, Dmap c & Dmap d.

Page 9 looks like so:

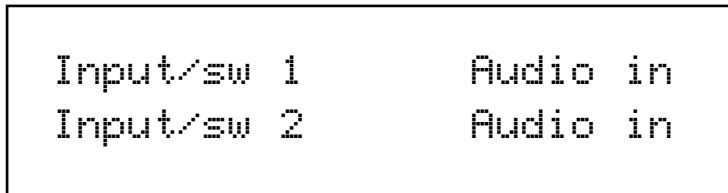

The higher parameter is "Input/sw 1". In this case with a value of Audio in.

This parameter determines what the Input/sw 1 input is going to do. Use the higher Data knob to adjust this parameter. In the Audio in position the Input is configured to accept external audio signals. In the Switch position the input is configured to work as a Footswitch input. In this case a Footswitch that is normally open. In the Switch-I position the input is configured to work as a Footswitch input. In this case a sustain pedal that is normally closed. The range of this parameter is Audio in, Switch & Switch-I. This parameter is memorised as Global.

The lower parameter is "Input/sw 2". In this case with a value of Audio in.

This parameter determines what the Input/sw 2 input is going to do. Use the lower Data knob to adjust this parameter. In the Audio in position the Input is configured to accept external audio signals. In the Switch position the input is configured to work as a Footswitch input. In this case a Footswitch that is normally open. In the Switch-I position the input is configured to work as a Footswitch input. In this case a sustain pedal that is normally closed. The range of this parameter is Audio in, Switch & Switch-I. This parameter is memorised as Global.

Page 10 looks like so:

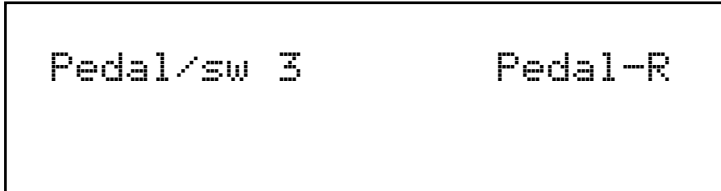

The parameter is "Pedal/sw 3". In this case with a value of Pedal-R.

This parameter determines what the Pedal/sw 3 input is going to do. Use the higher Data knob to adjust this parameter. In the Pedal-R position, the input is configured to work as an Expression Pedal input & can mapped into any controller using the Pedal/breath parameter on page 4 of this menu. In this case an Expression Pedal with the control output on the ring of the pedal jack. In the Pedal-T position, the input is configured to work as an Expression Pedal input & can mapped into any controller using the Pedal/breath parameter on page 4 of this menu. In this case an Expression Pedal with the control output on the tip of the pedal jack. i.e. a Korg EXP2 Expression Pedal. In the Switch position the input is configured to work as a Footswitch input. In this case a Footswitch that is normally open. In the Switch-I position the input is configured to work as a Footswitch input. In this case a sustain pedal that is normally closed. The range of this parameter is Pedal-R, Pedal-T, Switch & Switch-I. This parameter is memorised as Global.

Page 11 looks like so:

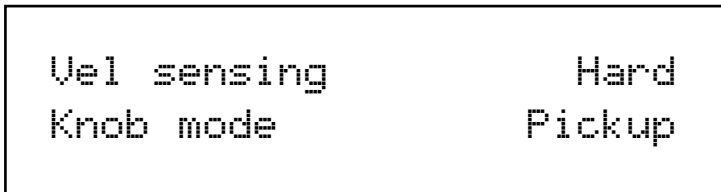

The higher parameter is "Vel sensing". In this case with a value of Hard.

This parameter alters the velocity curve of the Nova II keyboard. Use the upper Data knob to adjust this parameter. This is global & applies to all modes. In the Hard position, large Velocity changes are required to create a big change in response. This is good for weighted & semi-weighted keyboard actions. In the Soft position, not so large Velocity changes are required to create a big change in response. This is good for cheaper keyboard actions. The range of this parameter is Hard & Soft. This parameter is memorised as Global.

The lower parameter is "Knob mode". In this case with a value of Pickup.

This parameter determines if the values of Knob parameters jumps immediately to the actual position of the Knob as soon as it is turned or if the Knob has to pass "through" the value of the edited parameter before the knob starts editing the parameter. Use the lower Data knob to adjust this parameter. In the Normal position the value of the parameter being edited jumps to the value of the Knob as soon as a knob is turned. This is good when creating sounds as the parameters are always "Live". In the Pickup position no change to the parameter being edited will take place until the Knob is turned so that the it has passed "through" the value of the edited parameter, thereby "picking it up". The knob then becomes "live" & will start editing the parameter & will start to transmit the appropriate controller. The range of this parameter is Normal & Pickup.



NOTE:

When this parameter is set to "Pickup" mode no controller data will be sent & no edits to the parameter by Knob movements will occur until the Knob parameter has been picked up.

Page 12 looks like so:

```
Incoming control
change                Enabled
```

The parameter is "Incoming control change". In this case with a value of Enabled.

This parameter determines if the Nova II keyboard responds to incoming MIDI controller messages or not. Use the upper Data knob to adjust this parameter. This filter is global & applies to all modes. The range of this parameter is Enabled & Disabled. This parameter is memorised as Global.



NOTE:

The Incoming Control Change filter does not filter Bank select messages. (CC00 and CC32) These can be filtered using the Incoming Program Change filter if required.

Page 13 looks like so:

```
Incoming program
change                Enabled
```

The parameter is "Incoming program change". In this case with a value of Enabled.

This parameter determines if the Nova II keyboard responds to incoming MIDI program change messages or not. Use the upper Data knob to adjust this parameter. When this parameter is set to Enabled any Program Change messages sent on Bank 0 will refer to the Program Map. This can be overridden by sending Bank & Program Change messages to a different Bank. Refer page 137 for details on the Bank messages received by Nova II keyboard. When this parameter is set to Favourites any Program Change messages will always refer to the Favourites map regardless of any Bank messages that have been received. When this parameter is set to Disabled. all incoming bank & program change messages are ignored. This filter is global & applies to all modes. The range of this parameter is Enabled, Favourites & Disabled. This parameter is memorised as Global.



NOTE:

If the Incoming Program Change filter is set to Disabled it also filters out Bank select messages. (CC00 & CC32)

Page 14 looks like so:

```
Prog change TX      On
Finder demos        Off
```

The higher parameter is "Prog change TX". In this case with a value of On.

This parameter determines if the Nova II keyboard transmits MIDI program change & Bank messages when a new Program or Performance is selected. (This includes program changes within a Part of a Performance) Use the higher Data knob to adjust this parameter. In the On position whenever a new Program or Performance is selected the appropriate Program change message & Bank message is sent on the appropriate channel. In the Off position no Program change or Bank change messages will be transmitted. The range of this parameter is On & Off. This parameter is memorised as Global.



NOTE:

This is for Internal sounds only. Setting this parameter to Off will have no affect on the Transmission of "External" Master keyboard functions, If these are active they will always be transmitted when a new Performance is selected.

The lower parameter is "Finder demos". In this case with a value of Off.

This parameter determines if the "Finder" plays a demo or not when activated. Use the lower Data knob to adjust this parameter. In the On position whenever the Finder mode is activated a small demo tune will play in the style of the category currently assigned to the selected program. In the Off position the finder function still works but no demo plays. This is useful when working with an external sequencer & auditioning sounds while the sequencer is running. The range of this parameter is On & Off. This parameter is memorised as Global.

Page 15 looks like so:

Sysex Tx delay	070ms
Temp disp time	100

The higher parameter is "Sysex TX delay". In this case with a value of 070.

This parameter determines the speed at which Data dumps made by the Nova II keyboard are transmitted. Use the higher Data knob to adjust this parameter. This can be useful when working with some PC's & MIDI interfaces that cannot receive the sysex data reliably. (i.e. Packet errors happen when the dump is played back in.) The range of this parameter is in Milliseconds & describes the pause between separate dumps in a sysex stream. The range of this parameter is 000ms to 127ms. This parameter is memorised as Global.



NOTE:

This is not a definite "Fix it" for Packet errors. If the problem still persists try a different Computer/Sequencer package/MIDI Interface. Packet errors are not a "Bug" in the Nova II keyboard but a problem with the device recording & playing back the Sysex dump. This parameter simply tries to make it easier for equipment that does not work properly work.

The lower parameter is "Temp display time". In this case with a value of 100.

This parameter determines the time that temporary displays remain on the display. (for example if any menu is open. i.e. flashing, & any knob is adjusted, the display will change from the menu to the knob parameter until the adjustment of the knob is stopped. Then after a short period the display reverts to the menu. This parameter determines that time.) Use the lower Data knob to adjust this parameter. The range of this parameter is 000 to 127. This parameter is memorised as Global.

Page 16 looks like so:

Program change	002
Selects	Perf A010

The Nova II keyboard features a "Favourites" mode that allows any incoming MIDI Program Change message or Keypad selection to call up any Program or Performance from any Bank, or select a new Arpeggiator Pattern for the currently selected program. The Favourites are user programmable & are Memorised as Global. To select the Favourite mode simply press the Favourites button in the Mode Section. See page 27 for details on the Favourites button. To select the Favourites mode via MIDI send a Bank Message of 0 (Controller 32 with a value of 0). When this Bank is selected any incoming MIDI Program Changes & Keypad selections conform to the sequence in the Favourites memories. Assigning Programs, Performances & Arp patterns to Favourite locations can be done with the assign button in the Mode section. See page 28 for details on the Assign (favourites) button. In this page not only Programs & Performances can be assigned but also Arpeggiator Patterns & Current Bank status.



NOTE:

Editing Favourites from within this menu provides a convenient way of inspecting/editing the Favourites without having to enter the Favourites mode.

The higher parameter is "Prog change". In this case with a value of 002.

This parameter shows which Part of the Favourites Map will be displayed / Edited. Use the higher Data knob to adjust this parameter. The Favourites Map allows incoming MIDI Program Change Messages to call up any sound in the Nova II keyboard. This not only allows keyboards & sequencers that do not support MIDI Bank Select Messages access to any sound via MIDI but also allows a user "Order" of sounds to be created which can be very useful in live performance. The range of this parameter is 000 to 127. This parameter is memorised as Global.



The Program map can be made active at all times by setting the “Incoming program change” parameter on page 13 of the Global mode to “Favourites”.



When a Program/Part receives a valid Bank Select Message (Controller 32) via MIDI IN, the bank will continue to remain selected for the Program/Part until another Bank Select Message is received via MIDI IN.



This “Favourites Map” is assigned to MIDI Bank 0(Controller 32 with a value of 0). If this message is received the Nova II keyboard will switch from normal operation to the Performance Map. Any Program changes received after that will be re-mapped according to the Performance Map. This can be disabled by sending another MIDI Bank Message calling up either one of the Program or Performance Banks. See page 137 for details on the Bank Messages received by Nova II keyboard.



To write any changes to the performance map into memory press the “Write” button while this page is displayed. Also note the “Memory Protect” has to be set to “Off” for this to be possible.

The lower parameter is “Selects”. In this case with a value of Perf A010.

This parameter shows which sound is assigned to the selected Program Message set in the parameter above. Use the lower Data knob & the Bank button to adjust this parameter. In this case the sound assigned is Performance A010. Pressing the Bank button while in this mode allows the selection of any of the Performance or Program Banks. Using the lower Data knob allows any sound from the selected Bank to be set. The range of this parameter is Curr, Prog A, Prog B, Perf A, Arp M (Mono patterns), Arp P (Poly Patterns) & Arp U (User patterns). This parameter is memorised as Global.

Page 17 looks like so:

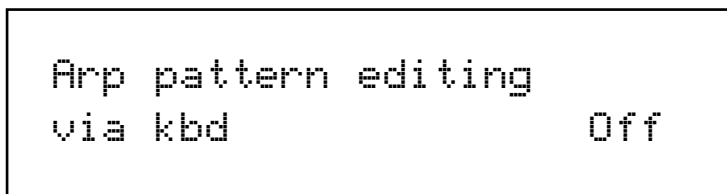

The parameter is “Arp pattern editing via kbd”. In this case with a value of Off.

This parameter determines if the Arpeggiator pattern data can be entered via the keyboard or not. When this parameter is set to Off, no editing of Arpeggiator patterns via a keyboard is possible, only the step type editing on pages 19 of the Global mode. If this parameter is set to On, Notes & Velocity can be entered directly from the keyboard. To do this set this parameter to On, then select a Pattern & select the number of steps in the pattern required in page 18 of Global mode. Now go to page 19 of global mode & check that the pattern is on step 1. While in page 19 pressing a note on the keyboard will enter the note value & velocity value directly into the pattern. The note off will automatically advance the pattern to the next step. A sustain pedal on the keyboard can also be used when in this mode. If no note is held down & the sustain pedal is pressed a Rest is inserted at the current step. Releasing the sustain switch advances the pattern to the next step. Similarly, pressing the pedal while no note is being played then, while still pressing the sustain switch, a note is played on the keyboard, inserts a tie at the current step. Releasing the Note on the keyboard then advances the pattern to the next step. Similarly, pressing the pedal while a note is being played inserts a Glide to at the current step. Releasing the Note on the keyboard then advances the pattern to the next step. The range of this parameter is Off, On, Note only, Vel only & Gate only.. This parameter is memorised as Global.

Page 18 looks like so:

User pattern	000
No of steps	32

The higher parameter is "User Pattern". In this case with a value of 000. This parameter determines which of the User Patterns for the Arpeggiator is to be edited with the following pages. Use the upper Data knob to adjust this parameter. The range of this parameter is 000 to 127. This parameter is memorised as Global.



User Patterns 000 to 63 are User Monophonic Patterns & User Patterns 64 to 127 are User Polyphonic Patterns.



To write any changes to the currently selected pattern into memory press the "Write" button while any of the pattern edit pages are displayed. Also note the "Memory Protect" has to be set to "Off" for this to be possible.

The lower parameter is "No of Steps". In this case with a value of 32. This parameter determines The number of steps in the chosen User Pattern. Use the lower Data knob to adjust this parameter. The range of this parameter is 01 to 64. This parameter is memorised as Pattern data.

Page 19 looks like so:

Step	Note	Vel.	Gate
01	01	127	Norm

The higher parameter is "Step Note Vel. Gate". In this case with a value of Note. This parameter determines the type of pattern parameter is going to be edited with the lower Data knob. Use the upper Data knob to adjust select the parameter to be edited. The cursor indicates the current selection, in this case Note. When this parameter is set to "Step" the value of the parameter below it determines the step to be edited. Use the lower Data knob to adjust this parameter. The range of this parameter is 01 to 64 but depends on the value set in the "No of Steps" parameter above. When this parameter is set to "Note" the value of the parameter below it determines the note value of the currently selected step. Use the lower Data knob to adjust this parameter. The range of this parameter is 01 to 12 for the User Monophonic patterns (000 to 063) & -36 to +36 for the User Polyphonic patterns (064 to 127) When this parameter is set to "Vel." the value of the parameter below it determines the velocity of the note at the currently selected step. Use the lower Data knob to adjust this parameter. The range of this parameter is 1 to 127. When this parameter is set to "Gate" the value of the parameter below it determines the gate time of the note at the currently selected step. In the Normal position the gate equals one step unless the following step is a tie. In the Tie position the notes are tied together. Use the lower Data knob to adjust this parameter. In the Rest position the note is silent. in the Glide position the Portamento effect is engaged as it does in Autoglide. The range of this parameter is Norm, Tie, Rest, Glide. Refer to page 35 for details on programming user patterns. These parameters are memorised as Pattern data.



The Note parameter can only be accessed if the current step's gate is set to Norm or Glide.



To write any changes to the currently selected pattern into memory press the "Write" button while any of the pattern edit pages are displayed. Also note the "Memory Protect" has to be set to "Off" for this to be possible.

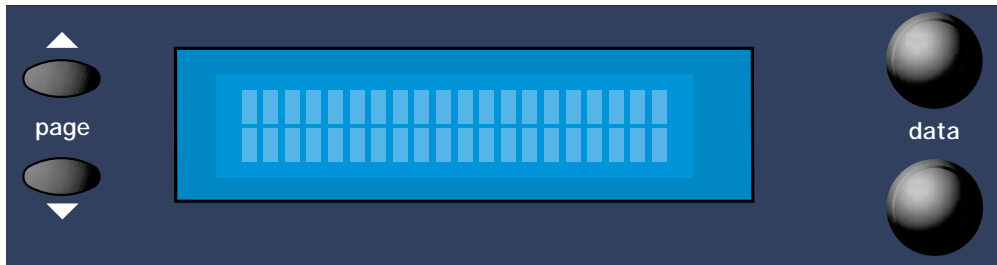

The Display shows the currently selected Performance or Program Name, Bank & Number. When editing Knobs on the front panel, the relevant parameter name & value is displayed.

Data - Knobs

When editing parameters in Menus, the upper Data Knob on the right of the display is used to edit the higher parameter's value. Similarly the lower parameter's value can be edited in the same way using the lower Data knob.

Page - Buttons

When editing parameters in Menus, there are usually several "Pages" within each menu. The Default page on pressing any menu button is the page selected when the Globals were last saved. Higher pages can be accessed by pressing the "Page Up" button & lower pages can be accessed by pressing the "Page Down" button.



NOTE:

The page buttons can also be used in conjunction with the keys on the keyboard to directly enter note values into parameters such as "Range" in Part edit of Performances (see page 126 for details) & "Tuning" of Drum Programs. (see page 122 for details)

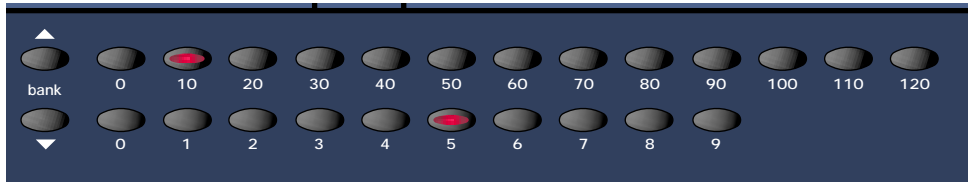

This section contains all the buttons used in the selection of Programs, Performances & Favourites.

Firstly select the desired mode (Program, Performance or Favourites) using the Mode section.

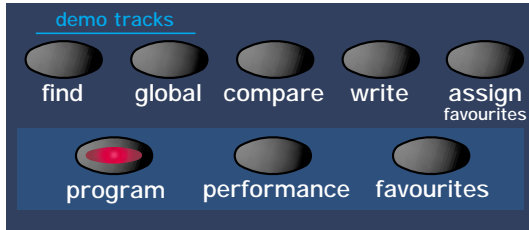

To select a specific number requires only 2 button presses, even if the number has 3 digits. For example to select Program 123, make sure the Nova II keyboard is in the Program mode (the Program button is lit), & simply press the 120 button & the 3 button in the Keypad section & the display shows:

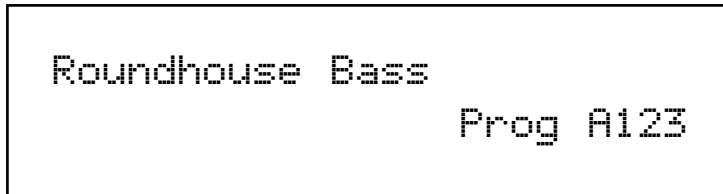

To select Program 001, make sure the Nova II keyboard is in the Program mode (the Program button is lit), & simply press the 0 button on the top row of the Keypad section & the 1 button on the bottom row of the Keypad section & the display shows:

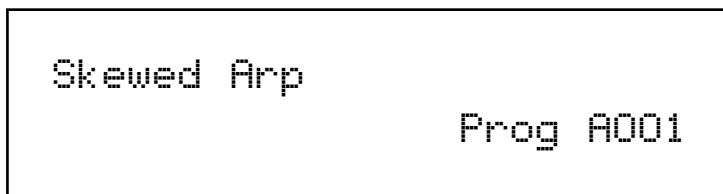

The Bank buttons in the Keypad section change the Bank currently selected. There are 4 Banks of 128 Programs, 2 banks of 128 Performances & 1 Bank of Favourites. Pressing the bank up button once & the display shows:

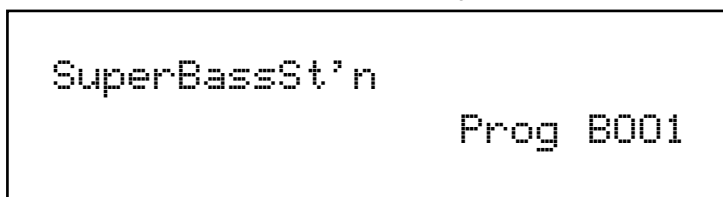

NOTE:

As there is only 1 Bank of Favourites the Bank buttons will do nothing in the Favourites mode.



NOTE:

When selecting a Drum Map Program it is only possible to select programs 000 to 049.

KEYPAD SECTION



In the write procedure the Keypad can be used for entering characters into the soundname. When in the naming page of the write procedure & the display shows for example:

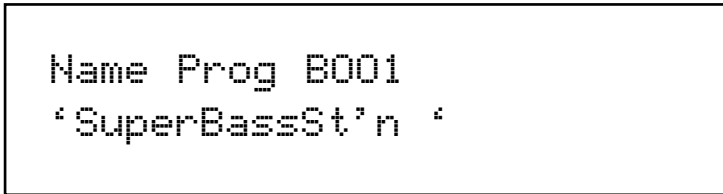

The name of the sound can be altered using the Data knobs when in this mode, but also the Page Up & Down buttons, the Keypad & the Bank buttons. Pressing the Page Up button while in this mode inserts a space at the cursor position & pressing Page Down while in this mode deletes the character at the cursor. The Keypad & Bank buttons also provide useful shortcuts when in this mode. Pressing the keyboard buttons with or without the 2 bank buttons perform several functions. These are as follows.

Top Row

a b c d e f g h i j k l m

Top Row + Bank Up button (momentary action)

n o p q r s t u v w x y z

Top Row + Bank Down button (latched action)

A B C D E F G H I J K L M

Top Row + Bank Up & Down buttons together

N O P Q R S T U V W X Y Z

Bottom Row

0 1 2 3 4 5 6 7 8 9

Bottom Row + Bank Up button (momentary action)

Space . - # () [] ! *

Bottom Row + Bank Down button (latched action)

[Current word 1st] [Current word Last] [Previous word 1st] [Next word 1st] [Previous word last]

[Next word last] [Previous space] [Next space] [1st char] [Last char]

Bottom Row + Bank Up & Down buttons together

[Toggle case char] [Char upper case] [Char lower case] [All words lower case with upper case first letter] [All words upper case] [All words lower case] [Rotate text left] [Rotate text right] [Clear text] [Restore text]

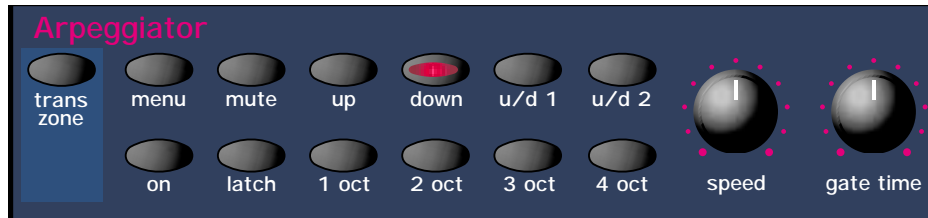

This section contains all the Knobs & buttons associated with the Arpeggiator.

Transpose zone- Button

This button when pressed, makes an area of the keyboard active for real-time Arpeggiator transposition. When active, the Real Time Transpose zone button is lit. While the real-time transpose zone is active, playing notes within the zone will transpose Arpeggiators in real-time (providing their Real-time transpose parameter is set to On – this parameter is accessed in the Arpeggiator Menu). Notes played within an active real-time transpose zone can only be used for this purpose. They will not trigger voices in Programs or Parts.

The amount of transposition applied to an Arpeggiator corresponds to the difference in semitones between the note played & the note defined by the "Arp Transpose Reference Note" (set in the Global Menu). The transposition can be negative as well as positive. For example, if the "Arp Transpose Reference Note" is defined as note C3, playing C#3 will result in the whole arpeggio being transposed up one semitone from its original key. If Bb3 is played, the whole arpeggio will now be transposed down two semitones from its original key & so on. To return the arpeggio to its original key (a transposition of zero semitones), it is necessary to play the same note value as defined by the "Arp Transpose Reference Note".

The size & limits of the real-time transpose zone can be set by pressing the Range button while the Arpeggiator Menu is active (the Arp Menu button is flashing). See the Arpeggiator section for more details.

The whole real-time transpose zone can be detuned by up to $-64 / +63$ semitones. This can be particularly useful if the defined real-time transpose zone does not include the "Arp transpose reference note" (set in the Global Menu) to which all real-time transpositions are relatively calculated. The detuning of the real-time transpose zone can be set by pressing the Tune button while the Arpeggiator Menu is active (the Arp Menu button is flashing). See the Arpeggiator section for more details.

The size & detuning of the real-time transpose zone as well as the Real Time Transpose button status (which determines whether the zone is active or not) are saved along with the Program when in Program Mode or a Performance if in Performance Mode.



NOTE:

There is only one real-time transpose zone when in Performance Mode. Playing notes within the zone can potentially affect the Arpeggiators in every Part simultaneously.



NOTE:

If the keyboard is transposed up or down by using the transpose buttons, the position of the real-time transpose zone is also moved accordingly.



NOTE:

When the "Arpeggiator Real-time Transpose channel" parameter (set in the Global Menu) is set to a value in the range 1 to 16, playing a note within the active zone will also result in the transmission of a MIDI note message using the "Arpeggiator Real-time Transpose channel" MIDI channel. Playing this note information back from a sequencer will then transpose the Arpeggiators in the same manner as when the notes were originally played on the keyboard.

This feature could alternatively be used to provide an additional keyboard area used solely to control external MIDI equipment – even in Program Mode. Of course, any Arpeggiators used by the Program / Performance would probably then need their realtime transposing parameter disabled.

Menu - Button

When this button is pressed, a series of pages is available on the display containing parameters relevant to this section. In the Arpeggiator Section there are 7 pages available. These are selected using the page Up & page Down buttons to the left of the display. There are a maximum of 2 parameters displayed on any page. One for each line on the display. The upper & lower Data knobs on the right of the display are used to alter these parameters values.

ARPEGGIATOR SECTION

Page 1 looks like so:

Keysync	Off
---------	-----

The parameter is "Keysync". In this case with a value of Off.

This parameter controls the way the Arpeggiator resets itself when new notes are played on the keyboard. Use the higher Data knob to adjust this parameter. In the "Off" position the cycle of the Arpeggiator is not interrupted when new notes are played on the keyboard, the Arpeggiator simply changes the notes being played to the new ones. In the "On" position the cycle of the Arpeggiator is reset to the start of its patterns when new notes are played on the keyboard. In this condition if the Quantise parameter on page 3 of the Arp menu is set to "Off" it behaves like triggering a loop in a sequencer. If the Quantise parameter is set to modes 1 or 3, the reset will occur at the start of the next step. If the Quantise is set to modes 2 or 4, notes played slightly late will reset immediately & following steps will be in sync. The range of this parameter is On & Off. This parameter is memorised with a Program.

Page 2 looks like so:

Pattern Bank	Mono
Pattern no.	120

The higher parameter is "Pattern bank". In this case with a value of Mono.

This parameter determines type of Pattern the Arpeggiator will use. Use the upper Data knob to adjust the value. The "Mono" Bank is 128 preset patterns that are Monophonic, (a single note is played at any one time) The "Poly" Bank is 128 preset patterns that are Polyphonic, (all the notes played on the keyboard are played at once & transposed) the "User" Bank is 128 patterns that are user programmable in the Global Mode. Patterns 000 to 063 in this bank are Monophonic & 064 to 127 are Polyphonic. The range of this parameter is Mono, Poly, & User. This parameter is normally memorised with a Program, however if in Performance mode & the Arp bank & pattern used parameter on page 1 of the Special menu in the Part Edit section is set to Part, then the parameter is memorised with a Performance.

The lower parameter is "Pattern no.". In this case with a value of 120.

This parameter determines which pattern in the bank specified by the parameter above is used by the Arpeggiator. Use the lower Data knob to adjust the value The range of this parameter is 000 to 127. This parameter is normally memorised with a Program, however if in Performance mode & the Arp bank & pattern used parameter on page 1 of the Special menu in the Part Edit section is set to Part, then the parameter is memorised with a Performance.



NOTE:

You can assign pattern changes into Favourites locations when in this page. Simply select the Pattern bank & Pattern number you wish to save into a favourite location & press the Assign (favourites) button while in this page & select the favourites location using the Keypad & then press the Assign (favourites) button again to write it into the Favourites map.



NOTE:

In Performance mode, the Pattern Bank & Pattern number displayed on this page will be different to the Pattern Bank & Pattern number assigned to the Program in the currently selected part if the Arp bank & pattern used parameter on page 1 of the Special menu in the Part Edit section is set to Part.

Page 3 looks like so:

Latch type	Constant
Quantise	Mode 1

The higher parameter is "Latch type". In this case with a value of Constant.

This parameter determines how the "Latch" function behaves. Use the upper Data knob to adjust the value.

In the "Constant" position, when the "Latch" is "On", the Arpeggiator remembers what notes you last played. i.e. If you play a C triad & then release the keys on the keyboard, the Arpeggiator will not stop, it will continue to sweep through the C triad until a new set of notes is played, then it will sweep through the new notes until another set it played. etc. etc. In the "Pattern" position the Arpeggiator will behave as above except that it will stop when it reaches the end of the pattern. This is like playing a loop on a sampler. Again another powerful feature for live performance. The range of this parameter is Constant & Pattern. This parameter is memorised with a Program.

The lower parameter is "Quantise". In this case with a value of Mode 1.

This parameter determines if the Arpeggiation played is quantised to the Arpeggiator Sync parameters time signature or not. Use the lower Data knob to adjust the value. The Arpeggiator can correct timing errors for you in several different ways. The arpeggiator can correct timing errors by quantising the played notes like a sequencer package. (we will refer to this method as "Quantised") This corrects the mistakes but can introduce a "Skip" if you play late. i.e. the first note played is on the next quantised step. This is what would happen in a sequencer as well but can be not so useful for live performance so we have introduced a kind of "Intelligent Quantise". i.e. If you play slightly late those notes will sound immediately & the *next* step will be quantised. Additionally things change if MIDI Clock is being used. The Arpeggiator reads MIDI Start/Continue Messages. The pattern will start when one of these messages is received, but will not make any sound. When the keyboard is played in this condition, the Arpeggiator will play the correct step in the pattern, not start from the beginning of the pattern. Below is a table showing the different options:

MODES

Off = Not quantised.

Mode 1 = Quantised.

Mode 2 = Intelligently quantised.

Mode 3 = Quantised with the pattern locked to the sequencer & other quantised Arpeggiators.

Mode 4 = Intelligently quantised with the pattern locked to the sequencer & other quantised Arpeggiators.

The range of this parameter is Off, Mode 1, Mode 2, Mode 3 & Mode 4. This parameter is memorised with a Program.



NOTE:

In Performances if more than one Part has a Program with Arpeggiators activated & if these Programs have the Arpeggiators "Quantise" parameter set to active (modes 1, 2, 3 or 4) then activating any Arpeggiator will start all of the Arpeggiators in the Performance in Sync with each other. (Although you wont actually hear them until the correct Range and/or MIDI channel is triggered) This means that the phrases created by the separate Arpeggiators are always in sync even if triggered at different times.



NOTE:

This parameter also affects how the Keysync parameter on page 1 of this menu behaves. Refer page 62 for details.

Page 4 looks like so:

Velocity	Played
Real time trans	Off

The higher parameter is "Velocity". In this case with a value of Played.

This parameter determines how the velocity of the notes played effect the notes in the arpeggiation. Use the upper Data knob to adjust the value . If this parameter is set to "Played" then the velocities of the notes played will be duplicated in the notes played in the arpeggiation. If this parameter is set to "Full" then the velocities of the notes played will be at full velocity. (127) If this parameter is set to "Half" then the velocities of the notes played will be at half velocity. (63) If this parameter is set to "Prog" then the velocities of the notes played will be at the values programmed into the patterns. The range of this parameter is Played, Full, Half & Prog. This parameter is memorised with a Program.

The upper parameter is "Real time trans", in this example with a value of Off.

This parameter is used to determine whether the Arpeggiator can be transposed in real-time. Use the lower Data knob to adjust the value If set to "On" then the whole arpeggio can be transposed in real-time either by a note played inside the real-time transpose zone on the keyboard (active when the 'real time transpose' button is lit) or by notes received on the "Real-time Transpose Channel" (set in the Global Menu).

ARPEGGIATOR SECTION

The amount of transposition applied to the Arpeggiator corresponds to the difference in semitones between the note played & the note defined by the "Arp Transpose Reference Note" (also set in the Global Menu). The transposition can be negative as well as positive. For example, if the "Arp Transpose Reference Note" is defined as note C3, playing C#3 will result in the whole arpeggio being transposed up one semitone from its original key. If Bb3 is played, the whole arpeggio will now be transposed down two semitones from its original key & so on. To return the arpeggio to its original key (a transposition of zero semitones), it is necessary to play the same note value as defined by the "Arp Transpose Reference Note" (set in the Global Menu).

If this parameter is set to "Off", then no real-time transposition will be applied to the arpeggiator. It will continue to play in its original key even if note information is sent from the real-time transpose zone on the keyboard or the "Real-time Transpose Channel". The range of this parameter is On & Off. This parameter is memorised with a Program.

SETTING REAL-TIME TRANSPOSE ZONE PARAMETERS

These following parameters can be set only while the Arpeggiator Menu is active (the Arp Menu button is flashing)

REAL-TIME TRANSPOSE ZONE RANGE

This parameter can be edited by pressing the Range button while the Arpeggiator Menu is active (the Arp Menu button is flashing). The Range button lights up & the display shows :

```
Kbd t-zone hi      C2
Kbd t-zone lo      C1
```

The higher parameter is "Kbd t-zone hi" (Keyboard Real-time Transpose Zone highest note), in this example with a value of C2. Use the upper Data knob to adjust the value. Alternatively, you may edit this parameter by pressing the Page Up button (the Page Up button lights up while it is pressed) & playing the appropriate note on the keyboard while the button is held down. This parameter represents the highest note value used in the Real-time transpose zone range. The range of this parameter is C-2 to G8. This parameter is memorised with a Program when in Program Mode, or memorised with a Performance if in Performance Mode.

The lower parameter is "Kbd t-zone lo" (Keyboard Real-time Transpose Zone lowest note), in this example with a value of C1. Use the lower Data knob to adjust the value. Alternatively, you may edit this parameter by pressing the Page Down button (the Page Down button lights up while it is pressed) & playing the appropriate note on the keyboard while the button is held down. This parameter represents the lowest note value used in the Real-time transpose zone range. The range of this parameter is C-2 to G8. This parameter is memorised with a Program when in Program Mode, or memorised with a Performance if in Performance Mode.

To return to the previous display in the Arpeggiator Menu, press the Range button again (the Range button goes out).



NOTE:

It is possible to define the transpose zone with the highest note set to a value lower than the lowest value. This creates a reverse zone with a "hole" between the highest note & lowest note where the zone is not active.

REAL-TIME TRANSPOSE ZONE DETUNE

This parameter can be edited by pressing the Tune button while the Arpeggiator Menu is active (the Arp Menu button is flashing). The Tune button lights up & the display shows :

```
Kbd arp transpose
zone detune      +12
```

The only parameter is "Kbd arp transpose zone detune", in this example with a value of +12. Use the lower fast data knob to adjust the value. This parameter detunes the note value played from the transpose zone by the indicated amount of semitones. Therefore a value of +12 would shift all note values in the whole transpose zone up by one octave. This feature can be particularly useful if the transpose zone range does not include the "Arp Transpose Reference Note" (set in the Global Menu) to which all real-time transpositions are relatively calculated. The range of this parameter is -64 to +63. This parameter is memorised with a Program when in Program Mode, or memorised with a Performance if in Performance Mode.

To return to the previous display in the Arpeggiator Menu, press the Tune button again (the Tune button goes out).

Page 5 looks like so:

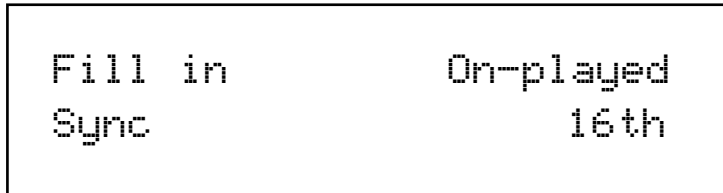

The higher parameter is "Fill in", in this case with a value of On - Played.

This parameter applies only to MONOPHONIC patterns, it has no affect on polyphonic patterns. Use the upper Data knob to adjust the value. In fact, this parameter can be thought of as two different parameters combined. The first Part (always "On" or "Off") determines how the Arpeggiator behaves when you play more or less notes than the Arpeggiator pattern was written to cope with.

When this Part of the parameter is set to "Off", if you play less notes than the pattern is expecting, the highest note you have played will be used for all the notes in the pattern data which are greater than your highest played note. If however, you have played more notes than the pattern was written to cope with, then played notes which are higher than the highest note in the pattern data are never sounded. When this Part of the parameter is set to "On", if you play less notes than the pattern is expecting, your played notes will be used intelligently for all the notes in the pattern data which are greater than your highest played note. If however, you have played more notes than the pattern was written to cope with, then played notes which are higher than the highest note in the pattern data are used, replacing their corresponding lower notes, every other time the pattern cycles around.

Perhaps the best way to understand how this works is by experimentation - altering the values & number of notes played while a mono arpeggiation is running. The second Part of the parameter ("Up", "Down" or "Played") determines which note ordering system is used for the monophonic pattern. When set to "Up", note 1 in the pattern data will refer to the lowest note played, note 2 the next note up & so on. When set to "Down", note 1 in the pattern data will refer to the highest note played, note 2 the next note down & so on. When set to "Played", note 1 in the pattern data will refer to the earliest note played, note 2 the next note to be played & so on. By adjusting this value, you can in effect, treble the number of available monophonic patterns you have access to !

The most musical setting for this parameter are any of the "On" options. The range of this parameter is Off - Up, On - Up, Off - Down, On - Down, Off - Played & On - Played. This parameter is memorised with a Program.



NOTE:

When the Arpeggiator is using one of the standard Up / Down patterns (Mono patterns 000 to 003), Fill-in can be used to determine how the pattern sweeps through the number of octaves selected. When the Fill-in parameter is set to any of the "On" settings, the pattern will sweep through all of the available in octaves in a single pass of the pattern. When the Fill-in parameter is set to any of the "Off" settings, the pattern will use each octave in turn for a single pass of the pattern.



NOTE:

The Note Ordering part of the Fill-in parameter is ignored by Mono Patterns 000 to 010 which generate arpeggios by algorithms rather than fixed pattern data.

The lower parameter is "Sync". In this case with a value of 16ths

This parameter determines the time signature at which the Arpeggiator runs from the Internal or External MIDI Clock.

Use the lower Data knob to adjust the value of this parameter. The range of this parameter is 32nd Triplet, 32nd, 16th Triplet, 16th, 8th Triplet, 16th Dotted, 8th, 4th Triplet, 8th Dotted, 4th, 2nd Triplet, 4th Dotted, 2nd, 1 Bar Triplet, 2nd Dotted, 1 Bar, 2 Bar Triplet, 1 Bar Dotted, 2 Bars, 4 Bar Triplet, 3 Bars, 5 Bar Triplet, 4 Bars, 3 Bar Dotted (4.5 Bars), 7 Bar Triplet, 5 Bars, 8 Bar Triplet, 6 Bars, 7 Bars, 5 Bar Dotted (7.5 Bars), 8 Bars, 6 Bar Dotted (9 Bars), 7 Bar Dotted (10.5 bars) & 8 Bar Dotted (12 Bars). This parameter is memorised with a Program.

Page 6 looks like so:

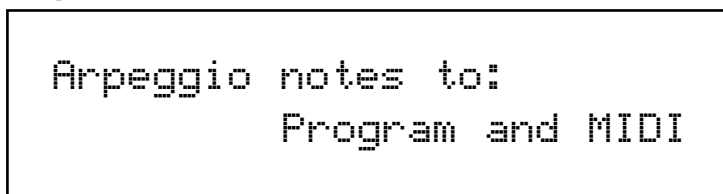

ARPEGGIATOR SECTION

The parameter is "Arpeggio notes to:". In this case with a value of Program & MIDI.

This parameter determines if the Arpeggiation is sent to the Nova II keyboard's sound engine, MIDI output or both. Use the lower Data knob to adjust the value. If this parameter is set to "Program" then no MIDI note data appears when the Arpeggiator is played but the Nova II keyboard is played by the Arpeggiation. If this parameter is set to Program & MIDI then the Nova II keyboard is heard playing the Arpeggiation & the Arpeggiation is also output via MIDI. If this parameter is set to "MIDI Only" then no sound is heard from Nova II keyboard when the Arpeggiator is played but the Arpeggiator is output via MIDI. The range of this parameter is Program Only, Program & MIDI & MIDI Only. This parameter is memorised with a Program.



In program mode, the MIDI channel used for Arp transmission is the Global channel. In Performance mode, the Part's MIDI channel is used. If the part's MIDI channel is set to Global or Omni, the Global channel is used.

Page 7 looks like so:

Constant pitch	Off
Output ranging	Off

The higher parameter is "Constant pitch". In this case with a value of Off.

This parameter applies only to Polyphonic patterns. If this parameter is set to "On" then all Arpeggiator note(s) will be sounded at a constant pitch regardless of where they have been played from the keyboard. If this parameter is set to "Off" then the transposition of the notes played by the Arpeggiator will be at the values programmed into the patterns. Use the upper Data knob to adjust the value. The range of this parameter is On & Off. This parameter is memorised with a Program.



The purpose of this parameter is to allow a sequence of notes to be played in exactly the same musical key regardless of where it has been triggered from the keyboard (real time transposing can still be used to transpose poly patterns if required). This is especially important if the Arpeggiator is being used to trigger drum patterns on an external Drum Machine or Sampler where each drum sound has a specific note value.



When Constant Pitch is activated, the Arp Poly pattern behaves monophonically, since if a chord was played on the keyboard, it would be pointless to send several NOTE ONs to the Program / MIDI OUT each with exactly the same note value.

The lower parameter is "Output ranging". In this case with a value of Off.

This parameter applies when Arpeggiators are used in Performance Mode. When set to 'On', this parameter checks to see if the Arpeggiator's final note value (taking into account the current 'octaves' shift & any 'real-time' transposing) falls within the Part's note range parameters. If the final note value falls outside this range, it is not passed on to the Program or MIDI. When Output Ranging is set to 'Off', the final note value will always be passed on to the Program or MIDI. Previous OS Versions always behaved as if Output Ranging was set to 'On'. Use the lower Data knob to adjust the value. The range of this parameter is On & Off. This parameter is memorised with a Program.



When Output Ranging is set to 'on', it is possible to obtain interesting Arp pattern variations by adjusting the Part's range values in such a way that certain Arpeggiated notes fall outside the Part's range & are not sounded.

Mute - Button

This button determines if the Arpeggiator is heard in the currently selected Program. When this button is unlit the Arpeggiator is on & the sound can be heard. In the "Muted" (Lit) position, the Arpeggiator is still running in the background but is no longer passing the notes to the Program or MIDI & the sound can no longer be heard. This parameter is memorised with a Program.

This feature will mute/unmute an external synthesiser being controlled by the arpeggiator via MIDI. (If the Arpeggio notes to: parameter on page 6 of the Arp menu is set to MIDI only or Program & MIDI)

Up - Button

This button assigns the Monophonic Up pattern to the Arpeggiator when lit. This parameter is memorised with a Program.



NOTE:

It is not possible to have a different pattern assigned to the Arpeggiator in the Pattern bank & Pattern No parameters of the Arp Menu when this button is active.

Down - Button

This button assigns the Monophonic Down pattern to the Arpeggiator when lit. This parameter is memorised with a Program.



NOTE:

It is not possible to have a different pattern assigned to the Arpeggiator in the Pattern bank & Pattern No parameters of the Arp Menu when this button is active.

U/D 1 - Button

This button assigns the Monophonic Up/Down 1 pattern to the Arpeggiator when lit. This parameter is memorised with a Program.



NOTE:

It is not possible to have a different pattern assigned to the Arpeggiator in the Pattern bank & Pattern No parameters of the Arp Menu when this button is active.

U/D 2 - Button

This button assigns the Monophonic Up/Down 2 pattern to the Arpeggiator when lit. This parameter is memorised with a Program.



NOTE:

It is not possible to have a different pattern assigned to the Arpeggiator in the Pattern bank & Pattern No parameters of the Arp Menu when this button is active.

On - Button

This button determines if the Arpeggiator is active or disabled in the currently selected program. Pressing this button makes the Arpeggiator active & the button will light. Pressing it again will deactivate the Arpeggiator & the light will go out. The range of this parameter is On & Off. This parameter is memorised with Programs in Program mode & Performances in Performance mode.

Latch - Button

This button determines the way in which the Arpeggiator remembers which notes you are playing or have played on the keyboard. When this is "Off" (unlit) the Arpeggiator will only sweep through its patterns when you hold down notes on the keyboard. If you are not playing any notes on the keyboard no arpeggio will be heard. If the "latch" is set to "On" (Lit) the Arpeggiator remembers what notes you last played. i.e. If you play a C triad & then release the keys on the keyboard the Arpeggiator will not stop, it will continue to sweep through the C triad until a new set of notes is played, then it will sweep through the new notes until another set it played. etc. etc. The range of this parameter is On & Off. This parameter is memorised with a Program.



NOTE:

This parameter can be controlled via the Sustain pedal in the Performance mode. To do so connect a Sustain Pedal to the Input/sw 1 (Sustain) socket & assign the socket to act as a suitable polarity Footswitch socket on page 9 of the global mode. The Nova II keyboard can read Sustain information as Arpeggiator latch On / Off, so depressing the Sustain Pedal connected to the Input/sw 2 socket will switch the Arpeggiator Latch "On" & releasing the Sustain Pedal will switch it "Off". For this to work properly set the "Sustain" parameter in the MIDI button menu for the selected Part to "Arp Latch". Additionally, this parameter may work in reverse to the manner described if the incorrect footswitch is used with the keyboard. If this is the case, change the polarity of the Footswitch socket on page 9 of the global mode. In Program Mode, the Sustain Pedal always latches the Arpeggiator while it is enabled. If the Arpeggiator is not enabled, the Sustain Pedal will act as a normal Sustain.

ARPEGGIATOR SECTION

1 Oct - Button

This parameter determines the number of octaves the Arpeggiator will sweep through. When this button is active (lit) the range of the Arpeggiators sweep is 1 octave. This parameter is memorised with a Program

2 Oct - Button

This parameter determines the number of octaves the Arpeggiator will sweep through. When this button is active (lit) the range of the Arpeggiators sweep is 2 octaves. This parameter is memorised with a Program.

3 Oct - Button

This parameter determines the number of octaves the Arpeggiator will sweep through. When this button is active (lit) the range of the Arpeggiators sweep is 3 octaves. This parameter is memorised with a Program.

4 Oct - Button

This parameter determines the number of octaves the Arpeggiator will sweep through. When this button is active (lit) the range of the Arpeggiators sweep is 4 octaves. This parameter is memorised with a Program..



NOTE:

When this parameter is set to use octaves greater than 1, then the "Fill in" parameter will affect how the the pattern sweeps through the octaves on the Monophonic Up/Down patterns (Mono 000 to 003). Refer to the notes on the "Fill in" parameter on page 64 for details.



NOTE:

It is not possible to have more than one of the Octave buttons selected at any one time.



NOTE:

It is not possible to have a different pattern assigned to the Arpeggiator in the Pattern bank & Pattern No parameters of the Arpeggiator Menu when this button is active.

Speed - Knob

This knob controls the speed at which the Arpeggiator sweeps through is patterns. Anticlockwise the speed is slow, clockwise the speed is fast. The range of this parameter is 64 bpm to 191bpm. This parameter is memorised with Programs in Program mode & Performances in Performance mode.



NOTE:

If the LFOs are synchronised to Internal MIDI Clock, this control sets the speed of the Internal MIDI Clock & the LFOs & / or Delay will be synchronised with the Arpeggiator at whatever time signature has been selected in the LFOs & / or Delay.

Gate time - Knob

This knob controls the "gate" time or duration of the notes being played by the Arpeggiator. Small values of gate time produce a "Staccato" effect & large values produce a "Legato" effect to the Arpeggiation. Anticlockwise the gate time is very short, clockwise the gate time is long. The range of this parameter is 25%, 50%, 75%, 99% & Tied. This parameter is memorised with Programs.



NOTE:

If the LFOs are synchronised to Internal MIDI Clock, this control sets the speed of the Internal MIDI Clock & the LFOs & / or Delay will be synchronised with the Arpeggiator at whatever time signature has been selected in the LFOs & / or Delay.



This section contains all the knobs & buttons associated with the Oscillators & Mixer.

Menu - Button

When this button is pressed a series of pages is available on the display containing parameters relevant to this section. In the Oscillator section there are 6 pages available. These are selected using the page Up & page Down buttons to the left of the display. There are a maximum of 2 parameters displayed on any page. One for each line on the display. The upper & lower Data knobs on the right of the display are used to alter these parameter's values.

Page 1 looks like so:

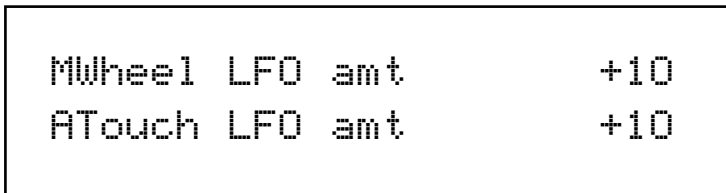

The higher parameter is "MWheel LFO1 amt". In this case with a value of +10. This parameter determines how the Mod Wheel affects the amount of LFO1 modulation on the selected Oscillator. Use the upper Data knob to adjust the value of this parameter. With this parameter it is possible to set the amount of modulation individually for each oscillator. The range of this parameter is -64 to +63. This parameter is memorised with a Program.



NOTE:

Mod Wheel LFO Amt does not apply to the 1*3, 2*3 or Noise buttons. If you attempt to alter this parameter when these buttons are selected the display will show "Menu Only Available For Osc 1,2 or 3" whilst the adjustment is being made then the display will revert back to the last edited parameter.

The lower parameter is "AT LFO1 amt". In this case with a value of +10. This parameter determines how the Aftertouch affects the amount of LFO1 modulation on the selected Oscillator. Use the lower Data knob to adjust the value of this parameter. With this parameter it is possible to set the amount of modulation individually for each oscillator. The range of this parameter is -64 to +63. This parameter is memorised with a Program.



NOTE:

Aftertouch LFO1 Amt does not apply to the 1*3, 2*3 or Noise buttons. If you attempt to alter this parameter when these buttons are selected the display will show "Menu Only Available For Osc 1,2 or 3" whilst the adjustment is being made then the display will revert back to the last edited parameter.

Page 2 looks like so:

Formant width	+10
Sync skew	+10

The higher parameter is "Formant width". In this case with a value of +10.

This parameter determines how much Formant Width is applied to the selected Oscillator. Use the upper Data knob to adjust the value of this parameter. With this parameter it is possible to set the amount of modulation individually for each oscillator. Refer to page 6 in the "About Analogue Synthesis section" for details on this parameter. The range of this parameter is 000 to 127. This parameter is memorised with a Program.



NOTE:

Formant Width does not apply to the 1*3, 2*3 or Noise buttons. If you attempt to alter this parameter when these buttons are selected the display will show "Menu Only Available For Osc 1,2 or 3" whilst the adjustment is being made then the display will revert back to the last edited parameter.

The lower parameter is "Sync skew". In this case with a value of +10.

This parameter determines how much of the Sync Skew effect is applied to the selected Oscillator. Use the lower Data knob to adjust the value of this parameter. With this parameter it is possible to set the amount of modulation individually for each oscillator. Refer to page 6 in the "About Analogue Synthesis section" for details on this parameter. The range of this parameter is -64 to +63. This parameter is memorised with a Program.



NOTE:

Sync Skew does not apply to the 1*3, 2*3 or Noise buttons. If you attempt to alter this parameter when these buttons are selected the display will show "Menu Only Available For Osc 1,2 or 3" whilst the adjustment is being made then the display will revert back to the last edited parameter.

Page 3 looks like so:

Sync key follow	+10
Pitch bend range	+10

The higher parameter is "Sync key follow". In this case with a value of +10.

This parameter determines how the "Virtual" Sync oscillator is transposed across the keyboard for the selected Oscillator. Use the upper Data knob to adjust the value of this parameter. With this parameter it is possible to set the amount of modulation individually for each oscillator. Refer to page 6 in the "About Analogue Synthesis section" for details on this parameter. The range of this parameter is 000 to 127. This parameter is memorised with a Program.



NOTE:

Sync Key Follow does not apply to the 1*3, 2*3 or Noise buttons. If you attempt to alter this parameter when these buttons are selected the display will show "Menu Only Available For Osc 1,2 or 3" whilst the adjustment is being made then the display will revert back to the last edited parameter.

The lower parameter is "Pitch bend range". In this case with a value of +10.

This parameter determines how the Pitch Bend Wheel affects the pitch of the oscillators. Use the lower Data knob to adjust the value of this parameter. With this parameter it is possible to set the pitch bend range individually for each oscillator allowing the creation of effects like using the Pitch bend control to bend into a chord. The range is -12 to +12 in semitone steps. This parameter is memorised with a Program.



NOTE:

Pitch bend Range does not apply to the 1*3, 2*3 or Noise buttons. If you attempt to alter this parameter when these buttons are selected the display will show "Menu Only Available For Osc 1,2 or 3" whilst the adjustment is being made then the display will revert back to the last edited parameter.

- Osc1 - Button
- Osc2 - Button
- Osc3 - Button
- 1*3 - Button
- 2*3 - Button
- Noise - Button
- 1*3 - FM - Button
- 2*3 - FM - Button
- Noise - FM - Button

All these buttons “select” which oscillator is going to be manipulated by the other parameters in this section. Osc 1 button selects Oscillator 1, Osc 2 button selects Oscillator 2, Osc 3 button selects Oscillator 3, 1*3 button selects the output of the Ring Modulator between Oscillators 1 & 3, 2*3 button selects the output of the Ring Modulator between Oscillators 2 & 3, Noise button selects the Noise Generator, 1*2 - FM button changes the modulation between Oscillators 1 & 2 from Ring Modulation to FM, 1*3 - FM button changes the modulation between Oscillators 1 & 3 from Ring Modulation to FM, Noise - FM button changes the modulation between Oscillators 1 & the Noise source from Ring Modulation to FM.

To adjust the “Octave” setting of Oscillator 1 press the “Osc 1” button, (it will light up indicating it is selected) & then press the “Octave” button within the Tune Part of this section. Adjusting the “Tune” knob will now change the octave setting of Oscillator 1. The display will change to indicate the parameter that has been selected & display the newly edited value. The Display will stay like this until another parameter is adjusted, in which case it will change to display the new parameter. To return to the display of the Program / Performance name & number press the appropriate Program or Performance button.



NOTE:

Only one Oscillator or one of the Ring Modulator / FM or the Noise Source can be selected / edited at one time.



NOTE:

Some parameters do not apply to all sound sources. i.e. The “Octave” parameter has no effect on the Noise generator. If this is the case, the display will read “Not Available” when the control is adjusted.

Solo - Button

This button is similar to a “solo” button on a mixing console. Pressing this button activates the solo function (The button is lit) & the currently selected sound source will be soloed. When the solo button is active (lit) the display will momentarily indicate that the selected sound source has been soloed. To return to normal operation press the solo button again. (unlit)

Copy - Button

This button activates a Copying utility & allows the settings of one Oscillator to be quickly copied to another. Pressing the button (The button is lit) when Oscillator 1 is selected activates the copying function for Oscillator 1’s parameters to be copied to another Oscillator & the display shows:

```
Copy oscillator 1
to?
```

It is now a simple matter of pressing the destination. (the oscillator that you wish to copy oscillator 1’s settings to) i.e. Press Oscillator 2 button & the display shows:

```
Oscillator 1 copied
to oscillator 2
```

OSCILLATOR SECTION



It is only possible to copy an Oscillator to another oscillator.



To exit this mode without copying an Oscillator, press the copy button again. (the Copy button is unlit)

Saw Waveform - **Button**
Sq waveform - **Button**
Special Waveform - **Button**

This is a menu of oscillator waveforms for the oscillator selected with the Osc 1, 2, & 3 buttons. To adjust the waveform of oscillator 1 press "Osc 1" button & select the waveform required. The selected waveform will light. The Saw button selects a Sawtooth waveform, the Sq button selects a Square waveform & the Special button selects Audio input 1, Audio input 2 & new additional waveforms to be available here with future software upgrades. This parameter is memorised with a Program.



These buttons do not apply to the Ring Mod Oscillators (1*3 & 2*3) or the Noise Generator.

Octave/Semi Knob
Cents - **Knob**

These knobs determine the Octave setting, Semitone transposition & fine tuning of the selected Oscillator. Turning the Octave/Semi knob clockwise raises the pitch of the selected oscillator by one semitone per click. Similarly turning the Octave/Semi knob anticlockwise lowers the pitch of the selected oscillator by one semitone per click. The total amount of transposition available is +/- 3 Octaves.

When this knob is turned clockwise one click from the 0 oct 0 semi setting position the display shows:

Octave	0
Semitones	+1

When this knob is turned anticlockwise one click from the 0 oct 0 semi setting position the display shows:

Octave	-1
Semitones	+11

When this knob is turned clockwise one click from the 0 oct +11 semi setting position the display shows:

Octave	+1
Semitones	0

When this knob is turned anticlockwise one click from the -1 oct 0 semi setting position the display shows:

Octave	-2
Semitones	+11

Of course the upper data knob should alter octaves & scale the semitones appropriately. Similarly the semitone values of +/- 12 should be interpreted as octave shifts & the semitone value returned to 0.

The Cents knob will shift the selected oscillator up 63 cents when turned fully clockwise & down 64 cents when turned fully anti-clockwise. These parameters are memorised with a Program.

Menu - Button (Voice control section)

Page 1 looks like so:

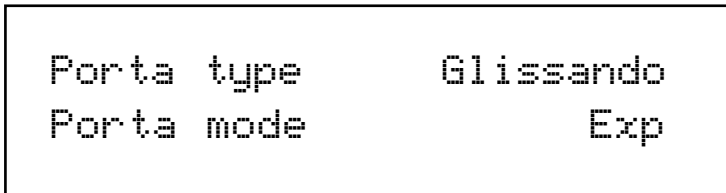

The higher parameter is "Porta type". In this case with a value of Glissando. This parameter determines If the Portamento effect is smooth or stepped in semitones. Use the upper Data knob to adjust the value of this parameter. In the Porta position the Portamento effect is smooth, notes glide smoothly from one pitch to another determined by the Porta Time setting. In the Gliss position the Portamento effect is Glissando, notes glide in semitone steps from one pitch to another determined by the Porta Time setting. The range is Porta & Gliss. This parameter is memorised with a Program.

The lower parameter is "Porta mode". In this case with a value of Exp. This parameter determines if the glide of the Portamento effect is Linear or Exponential. Use the lower Data knob to adjust the value of this parameter. Some synthesisers like the TB303* have an Exponential curve which gives them a "Character" to the way slides are performed, on the other hand for Portamento lead Linear is the norm. The range is Lin & Exp. This parameter is memorised with a Program.

Page 2 looks like so:

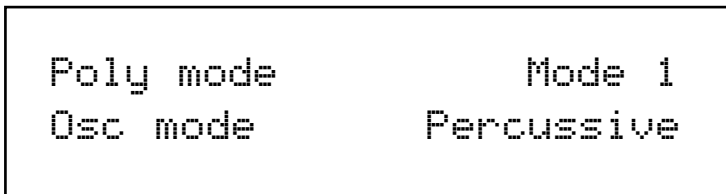

The higher parameter is "Poly mode". In this case with a value of Mode 1. This parameter determines If new voices are used when the same note is played. Use the upper Data knob to adjust the value of this parameter. In the "Mode 1" position the voice allocation behaves like most modern synthesisers. i.e. a new voice is allocated to every new note played even if the new note is being already played by another voice. In the "Mode 2" position the voice allocation behaves like vintage 8 / 6 voice analogue synthesisers. i.e. If a new note is played that is already being played by another voice the existing voice is soft retriggered & plays the new note. No new voice is allocated. The range is Mode 1 & Mode 2. This parameter is memorised with a Program.

The lower parameter is "Osc mode". In this case with a value of Percussive. This parameter determines if the Oscillators are reset on note on or not. Use the lower Data knob to adjust the value of this parameter. In the "Percussive" position the Oscillators are reset on note on. This makes it possible to create "Punchy" basses & Drum sounds. In the "Ensemble" position all the Oscillators are free running & this allows the creation of fat string sounds etc. The range is Percussive & Ensemble. This parameter is memorised with a Program.



If this parameter is set to Ensemble then the Osc start phase parameter on page 6 of this menu will not have any effect as this makes all oscillators freewheel, in which case no phase control is operational.

Page 3 looks like so:

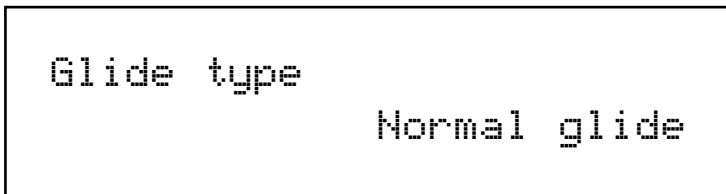

OSCILLATOR SECTION

The lower parameter is "Glide type". In this case with a value of Normal Glide.

This parameter determines how the Portamento is controlled. Turning the lower Data knob fully anticlockwise sets this parameter to the "Normal" position. In this mode the Portamento behaves normally. Turning this knob clockwise selects the "AutoGlide" option". In this mode the Portamento will be switched off when notes are played with a gap in-between them however when Legato (overlapping) notes are received the Portamento effect is switched on. This is particularly useful as it makes TB303* type glides in a sequencer very easy to program by simply overlapping the notes where you want the glide to occur. From this position turning the knob clockwise brings up the Preglide options. When these options are selected a "Preglide" is applied to the pitch of the oscillators starting a a pitch determined by the PreGlide selected & gliding up or down to the normal pitch. The time it takes to do this is determined by the Portamento time. The Preglide is triggered with every note received. Below is a description of the different types of PreGlide available.

2 semitones down	A Glide from 2 semitones down is applied to the Oscillators.
2 semitones up	A Glide from 2 semitones up is applied to the Oscillators.
5 semitones down	A Glide from 5 semitones down is applied to the Oscillators.
5 semitones up	A Glide from 5 semitones up is applied to the Oscillators.
7 semitones down	A Glide from 7 semitones down is applied to the Oscillators.
7 semitones up	A Glide from 7 semitones up is applied to the Oscillators.
12 semitones down	A Glide from 12 semitones down is applied to the Oscillators.
12 semitones up	A Glide from 12 semitones up is applied to the Oscillators.

The range of this parameter is Normal Glide, Auto Glide, 2 semitones down, 2 semitones up, 5 semitones down, 5 semitones up, 7 semitones down, 7 semitones up, 12 semitones down & 12 semitones up. This parameter is memorised with a Program.



NOTE:

You cannot have different settings of this parameter in different Envelopes.

Page 4 looks like so:

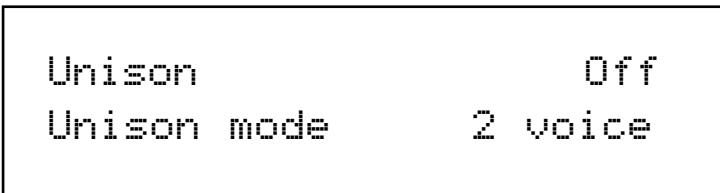

The higher parameter is "Unison". In this case with a value of Off.

This parameter activates the Unison mode.. Use the upper Data knob to adjust the value of this parameter. When this parameter is set to Off only one voice is used per note in a Program. When this parameter is set to On more than one voice is used per note in a Program. The number of voices used per note is determined by the Unison Voice No parameter on the next page. The Detuning of the voices is controlled by the Unison Detune parameter on the next page. The range of this parameter is On & Off. This parameter is memorised with a Program.



NOTE:

The Unison mode will not appear to do very much unless the Unison detune parameter has a value greater than 0.

The lower parameter is "Unison mode". In this case with a value of 2 voice.

This parameter determines the maximum number of voices can be used on one note when the Unison mode is active. Use the lower Data knob to adjust the value of this parameter. Larger values tend to create fatter sounds. The range of this parameter is 2 to 8. This parameter is memorised with a Program.



NOTE:

Large voice settings of the Unison mode can be quite polyphony hungry. For example a setting of 8 voice will produce a fat sound but 3 notes will consume 24 voices.

Page 5 looks like so:

Unison detune	008
VCO drift	064

The higher parameter is "Unison detune". In this case with a value of 8. This parameter determines the relative detuning of voices when the Unison mode above is active. Use the upper Data knob to adjust this parameter. When this parameter is set to low values only small shifts in tuning are applied to the different voices. When this parameter is set to high values only larger shifts in tuning are applied to the different voices. The range of this parameter is 000 to 127. This parameter is memorised with a Program.

The lower parameter is "VCO drift". In this case with a value of 64. This parameter determines the how the tuning of all the oscillators behave. Use the lower Data knob to adjust this parameter. When this parameter is set 000 the tuning between the oscillators is perfect. This is the case on "DCO" (Digitally Controlled Oscillator) synthesisers such as the Roland Juno 106 or Juno 60. Tuning this parameter up gradually increases the classic "VCO" (Voltage Controlled Oscillator) characteristics. At relatively low levels this parameter is similar to a quality VCO synth with all its oscillators tuned up. At 127 the oscillators are quite out of tune & it sounds like a VCO synth in need of a service! The range of this parameter is 000 to 127. This parameter is memorised with a Program.

Page 6 looks like so:

Osc start phase	000
-----------------	-----

The higher parameter is "Osc start phase". In this case with a value of 000. This parameter determines the phase at which the oscillators start at when a key is pressed. When this parameter is set to 000 the start phase of the oscillators is at 0°. When set to 32 the start phase of the oscillators is 90°. When set to 64 the start phase of the oscillators is 180°. When set to 96 the start phase of the oscillators is 270° & when set to 127 the start phase of the oscillators is approx 355°. The phase is smoothly adjustable from 0° to nearly 360° with this parameter. The range of this parameter is 000 to 127. This parameter is memorised with a Program.



NOTE:

This parameter will not have any effect at all if the Osc mode parameter on page 2 of this menu is set to Ensemble as this makes all oscillators freewheel, in which case no phase control is operational.



NOTE:

This parameter is useful in the creation of "Percussive" sounds & drums when set to either 32 (= 90°) or 96. (= 270°)

Portamento - Knob

This knob adjusts the Portamento effect on the currently selected Program. Fully anticlockwise no Portamento is heard. Turning the knob clockwise brings in the Portamento effect & notes will smoothly glide from one pitch to the next. The range of this parameter is 000 to 127. This parameter is memorised with Programs.

Oscillator Modulation Matrix



This is an extremely powerful feature of the Nova II keyboard. These controls affect the modulation of the selected oscillator. The buttons on the left are all "Destinations". They can all be modulated by the "Sources" which are the buttons on the right. The amount of modulation applied from any source is determined by the setting of the Mod Depth Knob. This can be either *Positive* modulation (Turning the Mod Depth Knob Clockwise) or *Negative* modulation. (Turning the Mod Depth Knob Anticlockwise) Additionally there is a manual Level Knob that allows a static "Offset" or "level" to be applied to any of the destinations.

For example, to adjust the level of the "Harden" setting of Oscillator 1 press the "Osc 1" button (it will light up indicating it is selected) & then press the "Harden" button within the modulation section to define the modulation destination. Now adjusting the Level knob will change the Harden setting of Oscillator 1.

Similarly to adjust the level of envelope 3 modulation of the "Harden" setting of Oscillator 1, press the "Osc 1" button (it will light up indicating it is selected) & then press the "Harden" button within the modulation section to define the modulation destination. Press the Env 3 button to define the modulation source. Now adjusting the Mod depth knob clockwise will modulate the Harden setting of Oscillator 1 by envelope 3.



NOTE:

This makes it possible for *all* modulation sources to affect any one destination in varying amounts & even in different polarities.

The display will change to indicate the parameter that has been selected & display the newly edited value. The Display will stay like this until another parameter is adjusted, in which case it will change to display the new parameter. To return to the display of the Program / Performance name & number press the Program or Performance button.



NOTE:

Only one source & destination can be edited at one time.



NOTE:

Even though only one source & destination combination can be edited at one time, All available combinations can happen at the same time



NOTE:

Some combinations do not apply. i.e. Pulse Width Modulation of Noise Generator. When such a parameter is edited the display shows "Not Available" & no audible effect is heard.

Possible Combinations & the effects Produced.



NOTE:

All these parameters are memorised with a Program.

Mix - Button
Level - Knob

This combination controls the Volume of the selected Oscillator, Noise Generator or Ring Modulator. Turning the Level Knob fully clockwise turns the selected sound source to full volume & fully anticlockwise turns the selected sound source to off. (No Volume)
 The range of this parameter is 000 to 127.

Mix - Button
Mod Depth - Knob
LFO 1 - Button

This combination controls the modulation of the Mix of the selected Oscillator, Noise Generator or Ring Modulator by LFO 1. Turning the Mod Depth Knob fully clockwise introduces Mix modulation from LFO 1 to the selected sound source in a *Positive* direction. Turning the Mod Depth Knob fully anticlockwise introduces Mix modulation from LFO 1 to the selected sound source in a *Negative* direction. In the "Mid" position there is no modulation at all. The range of this parameter is -64 to +63.

Mix - Button
Mod Depth - Knob
LFO 2 - Button

This combination controls the modulation of the Mix of the selected Oscillator, Noise Generator or Ring Modulator by LFO 2. Turning the Mod Depth Knob fully clockwise introduces Mix modulation from LFO 2 to the selected sound source in a *Positive* direction. Turning the Mod Depth Knob fully anticlockwise introduces Mix modulation from LFO 2 to the selected sound source in a *Negative* direction. In the "Mid" position there is no modulation at all. The range of this parameter is -64 to +63.

Mix - Button
Mod Depth - Knob
ENV 2 - Button

This combination controls the modulation of the Mix of the selected Oscillator, Noise Generator or Ring Modulator by ENV 2. Turning the Mod Depth Knob fully clockwise introduces Mix modulation from ENV 2 to the selected sound source in a *Positive* direction. Turning the Mod Depth Knob fully anticlockwise introduces Mix modulation from ENV 2 to the selected sound source in a *Negative* direction. In the "Mid" position there is no modulation at all. The range of this parameter is -64 to +63.

Mix - Button
Mod Depth - Knob
ENV 3 - Button

This combination controls the modulation of the Mix of the selected Oscillator, Noise Generator or Ring Modulator by ENV 3. Turning the Mod Depth Knob fully clockwise introduces Mix modulation from ENV 3 to the selected sound source in a *Positive* direction. Turning the Mod Depth Knob fully anticlockwise introduces Mix modulation from ENV 3 to the selected sound source in a *Negative* direction. In the "Mid" position there is no modulation at all. The range of this parameter is -64 to +63.

Mix - Button
Mod Depth - Knob
Wheel - Button

This combination controls the modulation of the Mix of the selected Oscillator, Noise Generator or Ring Modulator by the Mod Wheel. Turning the Mod Depth Knob fully clockwise introduces Mix modulation from the Mod Wheel to the selected sound source in a *Positive* direction. Turning the Mod Depth Knob fully anticlockwise introduces Mix modulation from the Mod Wheel to the selected sound source in a *Negative* direction. In the "Mid" position there is no modulation at all. The range of this parameter is -64 to +63.

OSCILLATOR SECTION

Pitch - **Button**
Level - **Knob**

This combination controls the Pitch Tracking of the selected oscillator. Turning the Level Knob fully clockwise makes the selected Oscillator track the keyboard in the normal way. i.e. Notes played one octave apart keyboard are transposed one octave apart. In the "Mid" position notes played one octave apart on the keyboard are transposed 1/2 an octave apart & fully anticlockwise notes played one octave apart on the keyboard produces no transposition at all. This can be useful for Ring Mod effects. The range of this parameter is 000 to 127.



NOTE:

This does not apply to the Noise, 1*3 & 2*3 Ring Modulator outputs. No audible effect to these sound sources will be heard if an attempt is made to adjust this parameter when these sound sources are selected.

Pitch - **Button**
Mod Depth - **Knob**
LFO 1 - **Button**

This combination controls the Pitch Modulation of the selected Oscillator by LFO 1. Turning the Mod Depth Knob fully clockwise introduces Vibrato from LFO 1 to the selected Oscillator in a *Positive* direction. Turning the Mod Depth Knob fully anticlockwise introduces Vibrato from LFO 1 to the selected Oscillator in a *Negative* direction. In the "Mid" position there is no modulation at all. The range of this parameter is -64 to +63.



NOTE:

This does not apply to the Noise, 1*3 & 2*3 Ring Modulator outputs. No audible effect to these sound sources will be heard if an attempt is made to adjust this parameter when these sound sources are selected & the display will show "Not Available".

Pitch - **Button**
Mod Depth - **Knob**
LFO 2 - **Button**

This combination controls the Pitch Modulation of the selected Oscillator by LFO 2. Turning the Mod Depth Knob fully clockwise introduces Vibrato from LFO 2 to the selected Oscillator in a *Positive* direction. Turning the Mod Depth Knob fully anticlockwise introduces Vibrato from LFO 2 to the selected Oscillator in a *Negative* direction. In the "Mid" position there is no modulation at all. The range of this parameter is -64 to +63.



NOTE:

This does not apply to the Noise, 1*3 & 2*3 Ring Modulator outputs. No audible effect to these sound sources will be heard if an attempt is made to adjust this parameter when these sound sources are selected & the display will show "Not Available".

Pitch - **Button**
Mod Depth - **Knob**
ENV 2 - **Button**

This combination controls the Pitch Modulation of the selected Oscillator by ENV 2. Turning the Mod Depth Knob fully clockwise introduces Pitch shift from ENV 2 to the selected Oscillator in a *Positive* direction. (Up) Turning the Mod Depth Knob fully anticlockwise introduces Pitch shift from ENV 2 to the selected Oscillator in a *Negative* direction. (Down) In the "Mid" position there is no modulation at all. The range of this parameter is -64 to +63.



NOTE:

This does not apply to the Noise, 1*3 & 2*3 Ring Modulator outputs. No audible effect to these sound sources will be heard if an attempt is made to adjust this parameter when these sound sources are selected & the display will show "Not Available".

Pitch - **Button**
Mod Depth - **Knob**
ENV 3 - **Button**

This combination controls the Pitch Modulation of the selected Oscillator by ENV 3. Turning the Mod Depth Knob fully clockwise introduces Pitch shift from ENV 3 to the selected Oscillator in a *Positive* direction. (Up) Turning the Mod Depth Knob fully anticlockwise introduces Pitch shift from ENV 3 to the selected Oscillator in a *Negative* direction. (Down) In the "Mid" position there is no modulation at all. The range of this parameter is -64 to +63.



NOTE:

This does not apply to the Noise, 1*3 & 2*3 Ring Modulator outputs. No audible effect to these sound sources will be heard if an attempt is made to adjust this parameter when these sound sources are selected & the display will show "Not Available".

Pitch - **Button**
Mod Depth - **Knob**
Wheel - **Button**

This combination controls the Pitch Modulation of the selected Oscillator by the Mod Wheel. Turning the Mod Depth Knob fully clockwise introduces Pitch shift from Mod Wheel to the selected Oscillator in a *Positive* direction. (Up) Turning the Mod Depth Knob fully anticlockwise introduces Pitch shift from Mod Wheel to the selected Oscillator in a *Negative* direction. (Down) In the "Mid" position there is no modulation at all. The range of this parameter is -64 to +63.



NOTE:

This parameter is calibrated in semitones, so a setting of 12 will produce an octave shift (Up) in the selected oscillator when a Mod Wheel value of 127 is received.



NOTE:

This does not apply to the Noise, 1*3 & 2*3 Ring Modulator outputs. No audible effect to these sound sources will be heard if an attempt is made to adjust this parameter when these sound sources are selected & the display will show "Not Available".

Width - **Button**
Level - **Knob**

This combination controls the Pulse Width of the selected Oscillator. Turning the Level Knob fully clockwise makes the selected Oscillator Pulse Width very thin. In the mid position the Pulse Width is 25% - 75% & fully anticlockwise the Pulse Width is 50% - 50%. The range of this parameter is -64 to +63.



NOTE:

This does not apply to the Oscillators that have Saw Waveforms selected or the Noise, 1*3 & 2*3 Ring Modulator outputs. No audible effect to these sound sources will be heard if an attempt is made to adjust this parameter when these sound sources are selected & the display will show "Not Available".

Width - **Button**
Mod Depth - **Knob**
LFO 1 - **Button**

This combination controls the Pulse Width Modulation of the selected Oscillator by LFO 1. Turning the Mod Depth Knob fully clockwise introduces Pulse Width Modulation from LFO 1 to the selected Oscillator in a *Positive* direction. Turning the Mod Depth Knob fully anticlockwise introduces Pulse Width Modulation from LFO 1 to the selected Oscillator in a *Negative* direction. In the "Mid" position there is no modulation at all. The range of this parameter is -64 to +63.



NOTE:

This does not apply to the Oscillators that have Saw Waveforms selected or the Noise, 1*3 & 2*3 Ring Modulator outputs. No audible effect to these sound sources will be heard if an attempt is made to adjust this parameter when these sound sources are selected & the display will show "Not Available".

Width - **Button**
Mod Depth - **Knob**
LFO 2 - **Button**

This combination controls the Pulse Width Modulation of the selected Oscillator by LFO 2. Turning the Mod Depth Knob fully clockwise introduces Pulse Width Modulation from LFO 2 to the selected Oscillator in a *Positive* direction. Turning the Mod Depth Knob fully anticlockwise introduces Pulse Width Modulation from LFO 2 to the selected Oscillator in a *Negative* direction. In the "Mid" position there is no modulation at all. The range of this parameter is -64 to +63.

OSCILLATOR SECTION



This does not apply to the Oscillators that have Saw Waveforms selected or the Noise, 1*3 & 2*3 Ring Modulator outputs. No audible effect to these sound sources will be heard if an attempt is made to adjust this parameter when these sound sources are selected & the display will show "Not Available".

Width - **Button**
Mod Depth - **Knob**
ENV 2 - **Button**

This combination controls the Pulse Width Modulation of the selected Oscillator by ENV 2. Turning the Mod Depth Knob fully clockwise introduces Pulse Width Modulation from ENV 2 to the selected Oscillator in a *Positive* direction. Turning the Mod Depth Knob fully anticlockwise introduces Pulse Width Modulation from ENV 2 to the selected Oscillator in a *Negative* direction. In the "Mid" position there is no modulation at all. The range of this parameter is -64 to +63.



This does not apply to the Oscillators that have Saw Waveforms selected or the Noise, 1*3 & 2*3 Ring Modulator outputs. No audible effect to these sound sources will be heard if an attempt is made to adjust this parameter when these sound sources are selected & the display will show "Not Available".

Width - **Button**
Mod Depth - **Knob**
ENV 3 - **Button**

This combination controls the Pulse Width Modulation of the selected Oscillator by ENV 3. Turning the Mod Depth Knob fully clockwise introduces Pulse Width Modulation from ENV 3 to the selected Oscillator in a *Positive* direction. Turning the Mod Depth Knob fully anticlockwise introduces Pulse Width Modulation from ENV 3 to the selected Oscillator in a *Negative* direction. In the "Mid" position there is no modulation at all. The range of this parameter is -64 to +63.



This does not apply to the Oscillators that have Saw Waveforms selected or the Noise, 1*3 & 2*3 Ring Modulator outputs. No audible effect to these sound sources will be heard if an attempt is made to adjust this parameter when these sound sources are selected & the display will show "Not Available".

Width - **Button**
Mod Depth - **Knob**
Wheel - **Button**

This combination controls the Pulse Width Modulation of the selected Oscillator by the Mod Wheel. Turning the Mod Depth Knob fully clockwise introduces Pulse Width Modulation from the Mod Wheel to the selected Oscillator in a *Positive* direction. Turning the Mod Depth Knob fully anticlockwise introduces Pulse Width Modulation from the Mod Wheel to the selected Oscillator in a *Negative* direction. In the "Mid" position there is no modulation at all. The range of this parameter is -64 to +63.



This does not apply to the Oscillators that have Saw Waveforms selected or the Noise, 1*3 & 2*3 Ring Modulator outputs. No audible effect to these sound sources will be heard if an attempt is made to adjust this parameter when these sound sources are selected & the display will show "Not Available".

Sync - **Button**
Level - **Knob**

This combination controls the Sync Effect on the selected Oscillator. Turning the Level Knob fully clockwise introduces the Sync Effect fully to the selected Oscillator & fully anticlockwise there is no Sync Effect at all. The range of this parameter is 000 to 127.



This does not apply to the Noise, 1*3 & 2*3 Ring Modulator outputs. No audible effect to these sound sources will be heard if an attempt is made to adjust this parameter when these sound sources are selected & the display will show "Not Available".

Sync - **Button**
Mod Depth - **Knob**
LFO 1 - **Button**

This combination controls the modulation of the Sync Effect on the selected Oscillator by LFO 1. Turning the Mod Depth Knob fully clockwise introduces Sync Effect from LFO 1 to the selected Oscillator in a *Positive* direction. Turning the Mod Depth Knob fully anticlockwise introduces Sync Effect from LFO 1 to the selected Oscillator in a *Negative* direction. In the "Mid" position there is no modulation at all. The range of this parameter is -64 to +63.



NOTE:

This does not apply to the Noise, 1*3 & 2*3 Ring Modulator outputs. No audible effect to these sound sources will be heard if an attempt is made to adjust this parameter when these sound sources are selected & the display will show "Not Available".

Sync - **Button**
Mod Depth - **Knob**
LFO 2 - **Button**

This combination controls the modulation of the Sync Effect on the selected Oscillator by LFO 2. Turning the Mod Depth Knob fully clockwise introduces Sync Effect from LFO 2 to the selected Oscillator in a *Positive* direction. Turning the Mod Depth Knob fully anticlockwise introduces Sync Effect from LFO 2 to the selected Oscillator in a *Negative* direction. In the "Mid" position there is no modulation at all. The range of this parameter is -64 to +63.



NOTE:

This does not apply to the Oscillators that have the Noise, 1*3 & 2*3 Ring Modulator outputs. No audible effect to these sound sources will be heard if an attempt is made to adjust this parameter when these sound sources are selected & the display will show "Not Available".

Sync - **Button**
Mod Depth - **Knob**
ENV 2 - **Button**

This combination controls the modulation of the Sync Effect on the selected Oscillator by ENV 2. Turning the Mod Depth Knob fully clockwise introduces Sync Effect from ENV 2 to the selected Oscillator in a *Positive* direction. Turning the Mod Depth Knob fully anticlockwise introduces Sync Effect from ENV 2 to the selected Oscillator in a *Negative* direction. In the "Mid" position there is no modulation at all. The range of this parameter is -64 to +63.



NOTE:

This does not apply to the Noise, 1*3 & 2*3 Ring Modulator outputs. No audible effect to these sound sources will be heard if an attempt is made to adjust this parameter when these sound sources are selected & the display will show "Not Available".

Sync - **Button**
Mod Depth - **Knob**
ENV 3 - **Button**

This combination controls the modulation of the Sync Effect on the selected Oscillator by ENV 3. Turning the Mod Depth Knob fully clockwise introduces Sync Effect from ENV 3 to the selected Oscillator in a *Positive* direction. Turning the Mod Depth Knob fully anticlockwise introduces Sync Effect from ENV 3 to the selected Oscillator in a *Negative* direction. In the "Mid" position there is no modulation at all. The range of this parameter is -64 to +63.



NOTE:

This does not apply to the Noise, 1*3 & 2*3 Ring Modulator outputs. No audible effect to these sound sources will be heard if an attempt is made to adjust this parameter when these sound sources are selected & the display will show "Not Available".

Sync - **Button**
Mod Depth - **Knob**
Wheel - **Button**

This combination controls the modulation of the Sync Effect on the selected Oscillator by the Mod Wheel. Turning the Mod Depth Knob fully clockwise introduces Sync Effect from the Mod Wheel to the selected Oscillator in a *Positive* direction. Turning the Mod

OCILLATOR SECTION

Depth Knob fully anticlockwise introduces Sync Effect from the Mod Wheel to the selected Oscillator in a *Negative* direction. In the "Mid" position there is no modulation at all. The range of this parameter is -64 to +63.



This does not apply to the Noise, 1*3 & 2*3 Ring Modulator outputs. No audible effect to these sound sources will be heard if an attempt is made to adjust this parameter when these sound sources are selected & the display will show "Not Available".

Harden- Button
Level - Knob

This combination controls the Harden Effect on the selected Oscillator & noise waveforms. Turning the Level Knob fully clockwise introduces the Harden effect fully to the selected Oscillator & fully anticlockwise there is no Hardening at all. The range of this parameter is 000 to 127.



This does not apply to the 1*3 & 2*3 Ring Modulator outputs. No audible effect to these sound sources will be heard if an attempt is made to adjust this parameter when these sound sources are selected & the display will show "Not Available".

Harden - Button
Mod Depth - Knob
LFO 1 - Button

This combination controls the modulation of the Harden effect of the selected Oscillator by LFO 1. Turning the Mod Depth Knob fully clockwise introduces Harden from LFO 1 to the selected Oscillator in a *Positive* direction. Turning the Mod Depth Knob fully anticlockwise introduces Harden from LFO 1 to the selected Oscillator in a *Negative* direction. In the "Mid" position there is no modulation at all. The range of this parameter is -64 to +63.



This does not apply to the Oscillators that have the, 1*3 & 2*3 Ring Modulator outputs. No audible effect to these sound sources will be heard if an attempt is made to adjust this parameter when these sound sources are selected & the display will show "Not Available".

Harden - Button
Mod Depth - Knob
LFO 2 - Button

This combination controls the modulation of the Harden Effect on the selected Oscillator by LFO 2. Turning the Mod Depth Knob fully clockwise introduces Harden Effect from LFO 2 to the selected Oscillator in a *Positive* direction. Turning the Mod Depth Knob fully anticlockwise introduces Harden Effect from LFO 2 to the selected Oscillator in a *Negative* direction. In the "Mid" position there is no modulation at all. The range of this parameter is -64 to +63.



This does not apply to the 1*3 & 2*3 Ring Modulator outputs. No audible effect to these sound sources will be heard if an attempt is made to adjust this parameter when these sound sources are selected & the display will show "Not Available".

Harden - Button
Mod Depth - Knob
ENV 2 - Button

This combination controls the modulation of the Harden Effect on the selected Oscillator by ENV 2. Turning the Mod Depth Knob fully clockwise introduces Harden Effect from ENV 2 to the selected Oscillator in a *Positive* direction. Turning the Mod Depth Knob fully anticlockwise introduces Harden Effect from ENV 2 to the selected Oscillator in a *Negative* direction. In the "Mid" position there is no modulation at all. The range of this parameter is -64 to +63.



This does not apply to the 1*3 & 2*3 Ring Modulator outputs. No audible effect to these sound sources will be heard if an attempt is made to adjust this parameter when these sound sources are selected & the display will show "Not Available".

Harden - **Button**
Mod Depth - **Knob**
ENV 3 - **Button**

This combination controls the modulation of the Harden Effect on the selected Oscillator by ENV 3. Turning the Mod Depth Knob fully clockwise introduces Harden Effect from ENV 3 to the selected Oscillator in a *Positive* direction. Turning the Mod Depth Knob fully anticlockwise introduces Harden Effect from ENV 3 to the selected Oscillator in a *Negative* direction. In the "Mid" position there is no modulation at all. The range of this parameter is -64 to +63.



NOTE:

This does not apply to the 1*3 & 2*3 Ring Modulator outputs. No audible effect to these sound sources will be heard if an attempt is made to adjust this parameter when these sound sources are selected & the display will show "Not Available".

Harden - **Button**
Mod Depth - **Knob**
Wheel - **Button**

This combination controls the modulation of the Harden Effect on on the selected Oscillator by the Mod Wheel. Turning the Mod Depth Knob fully clockwise introduces Harden Effect from the Mod Wheel to the selected Oscillator in a *Positive* direction. Turning the Mod Depth Knob fully anticlockwise introduces Harden Effect from the Mod Wheel to the selected Oscillator in a *Negative* direction. In the "Mid" position there is no modulation at all. The range of this parameter is -64 to +63.



NOTE:

This does not apply to the 1*3 & 2*3 Ring Modulator outputs. No audible effect to these sound sources will be heard if an attempt is made to adjust this parameter when these sound sources are selected & the display will show "Not Available".

FILTER SECTION

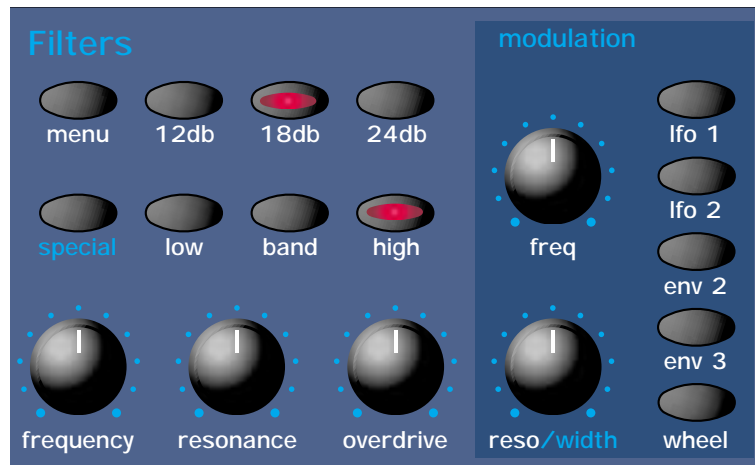

This section contains all the knobs & buttons associated with the Filter.

Menu - Button

When this button is pressed a series of pages is available on the display containing parameters relevant to this section. In the Filter section there are 6 pages available. These are selected using the page Up & page Down buttons to the left of the display.

There are a maximum of 2 parameters displayed on any page. One for each line on the display. The upper & lower Data knobs on the right of the display are used to alter these parameter's values.

Page 1 looks like so:

Filter tracking	000
Q norm amount	000

The higher parameter is "Filter tracking". In this case with a value of 000.

This parameter controls the amount of change to the Filter Cutoff Frequency (initially set by the Frequency knob.) by the pitch of the note being played. Use the lower Data knob to adjust this parameter. Fully anticlockwise this parameter does not effect the Cutoff Frequency of the filter if notes at different pitches are played. Clockwise from this position there will be an increasing amount of modulation. i.e. The Filter will be opened more as higher notes are played in the keyboard. This control is used to determine how the timbre of a sound changes over the keyboard. At the fully clockwise position the Filter tracks the pitch changes in a 1:1 ratio. The range of this parameter is 000 to 127. This parameter is memorised with a Program.

The lower parameter is "Q norm amount". In this case with a value of 000.

This parameter determines how the Resonance of the Filter behaves. Use the higher Data knob to adjust this parameter. Fully Anticlockwise the Resonance is added to the incoming signal to the filter. This means that higher levels of resonance will produce a louder output signal from the Filter. Fully Clockwise the output level of the filter is maintained regardless of the position of the resonance control. The range of this parameter is 000 to 127. This parameter is memorised with a Program.

Page 2 looks like so:

Fq Mwh LFO2 amt	+63
Res Mwh LFO2 amt	+63

The higher parameter is "Fq MWh LFO2 amt". In this case with a value of +63.

This parameter determines how the Modulation Wheel affects the amount of Modulation of the Cutoff Frequency of the Filter from LFO 2. This produces a Wah Wah type of effect. In the central position of the upper Data knob there is no change to the Filter Cutoff Frequency when the Modulation Wheel is engaged. Anticlockwise of centre there will be an increasing amount of Negative

modulation. i.e. The Filter will be closed more by LFO 2 when the Modulation Wheel is engaged. Clockwise of centre the modulation is Positive. i.e. The Filter will be increasingly opened by LFO 2 when the Modulation Wheel is engaged. The range of this parameter is -64 to +63. This parameter is memorised with a Program.

The lower parameter is "Res MWh LFO2 amt". In this case with a value of +63.

This parameter determines how the Modulation Wheel affects the amount of Modulation of the Resonance of the Filter from LFO 2. In the central position of the lower Data knob there is no change to the Filter Resonance when the Modulation Wheel is engaged. Anticlockwise of centre there will be an increasing amount of Negative modulation. i.e. The Filter will be made less Resonant by LFO 2 when the Modulation Wheel is engaged. Clockwise of centre the modulation is Positive. i.e. The Filter will be increasingly made more Resonant by LFO 2 when Modulation Wheel is engaged. The range of this parameter is -64 to +63. This parameter is memorised with a Program.

Page 3 looks like so:

Fq AT LFO2 amt	+63
Res AT LFO2 amt	+63

The higher parameter is "Fq AT LFO2 amt". In this case with a value of +63.

This parameter determines how the Aftertouch affects the amount of Modulation of the Cutoff frequency of the Filter from LFO 2. This produces the Growl effect. In the central position of the upper Data knob there is no change to the Filter Cutoff Frequency when the Aftertouch is engaged. Anticlockwise of centre there will be an increasing amount of Negative modulation. i.e. The Filter will be closed more by LFO 2 when the Aftertouch is engaged. Clockwise of centre the modulation is Positive. i.e. The Filter will be increasingly opened by LFO 2 when the Aftertouch is engaged. The range of this parameter is -64 to +63. This parameter is memorised with a Program.

The lower parameter is "Res AT LFO2 amt". In this case with a value of +63.

This parameter determines how the Aftertouch affects the amount of Modulation of the Resonance of the Filter from LFO 2. In the central position of the lower Data knob there is no change to the Filter Resonance when the Aftertouch is engaged. Anticlockwise of centre there will be an increasing amount of Negative modulation. i.e. The Filter will be made less Resonant by LFO 2 when the Aftertouch is engaged. Clockwise of centre the modulation is Positive. i.e. The Filter will be increasingly made more Resonant by LFO 2 when the Aftertouch is engaged. The range of this parameter is -64 to +63. This parameter is memorised with a Program.

Page 4 looks like so:

Fq AT amt	+63
Res AT amt	+63

The higher parameter is "Fq AT amt". In this case with a value of +63.

This parameter determines how the Aftertouch affects the amount of Modulation of the Cutoff frequency of the Filter. In the central position of the upper Data knob there is no change to the Filter Cutoff Frequency when the Aftertouch is engaged. Anticlockwise of centre there will be an increasing amount of Negative modulation. i.e. The Filter will be closed more when the Aftertouch is engaged. Clockwise of centre the modulation is Positive. i.e. The Filter will be increasingly opened when the Aftertouch is engaged. The range of this parameter is -64 to +63. This parameter is memorised with a Program.

The lower parameter is "Res AT amt". In this case with a value of +63.

This parameter determines how the Aftertouch affects the amount of Modulation of the Resonance of the Filter. In the central position of the lower Data knob there is no change to the Filter Resonance when the Aftertouch is engaged. Anticlockwise of centre there will be an increasing amount of Negative modulation. i.e. The Filter will be made less Resonant when the Aftertouch is engaged. Clockwise of centre the modulation is Positive. i.e. The Filter will be increasingly made more Resonant when the Aftertouch is engaged. The range of this parameter is -64 to +63. This parameter is memorised with a Program

Page 5 looks like so:

```
Overdrive curve      -64
Oscs filt bypass    Off
```

The higher parameter is "Overdrive curve." In this case with a value of -64.

This parameter determines the characteristic of the Overdrive effect. Use the upper Data knob to adjust this parameter. With a setting +00 normal clipping type of Distortion occurs. With at +ve value additional symmetrical distortion effects are introduced. With at -ve value addition asymmetrical distortion effects are introduced. The range of this parameter is -64 to+64. This parameter is memorised with a Program.

The lower parameter is "Oscs filt bypass". In this case with a value of Off.

This parameter determines if the Oscillators & Ring modulator outputs actually pass through the Filter or not. This allows the noise to be filtered independently of the Oscillators, which is particularly useful when creating drum sounds. When this parameter is set to the On position, all the oscillators & the outputs of the Ring Modulators minus the Noise (which is still going through the filter) are routed past the filter, to the Amp envelope. When this parameter is set to the Off position, all the oscillators, the outputs & the Ring Modulators plus the Noise are routed to the filter. The range of this parameter is -64 to +63. This parameter is memorised with a Program.

Page 6 looks like so:

```
Special type
filter width      000
```

The parameter is "Special type filter width". In this case with a value of 000.

This parameter determines the spacing/offset in Filter cutoff frequencies between the two elements of the "Special" filters. This is a duplicate of the Filter width parameter that is displayed when the special page is active. The reason for this is that it was found to be nice when editing for the display to jump back to this parameter when editing & as this parameter is duplicated here in this menu it will do exactly that. This can provide "Formant" type filters & speech like qualities can be easily realised. The Filter width is calibrated in semitones & allows specific offsets to be easily created. The range of this parameter is 000 to 127. Note that the Resonance modulation Knob in the Filter Modulation Matrix actually modulates the "Filter width" parameter & not the resonance when the "Special" filters are selected. The Resonance knob still retains its function as filter Resonance when in this mode. This parameter is memorised with a program.



NOTE:

Adjusting the value of this parameter will alter the value in the Special page. It is not possible to have different values set in the 2 pages.

12dB - **Button**
18dB - **Button**
24dB - **Button**

These buttons select the slope of the cutoff curve of the Filter. Only one can be selected at once. The effect is similar to a "Q" control on a parametric EQ. In the 12db position the Cutoff Frequency slope is less steep so in a Low Pass Filter the higher frequencies are not attenuated as much as they are in the 24 or 18db positions. This makes the resulting filtering in the 12db position more subtle than the 24db or 18db positions which you should select if you want the Cutoff Frequency to be more obvious.

Low - **Button**
High - **Button**
Band - **Button**

These buttons select the type of Filter to be used in this program. All have a very different sound. Below is a description of what parts of the sound the different Filters allow through the Filter. The Low button configures the Filter into a Low Pass Filter. A Low Pass Filter allows harmonics below a set frequency to pass through the Filter. Hence the name Low Pass Filter. The High button configures the Filter into a High Pass Filter. A High Pass Filter allows harmonics above a set frequency to pass through the Filter.

Hence the name High Pass Filter. The Band button configures the Filter into a Band Pass Filter. A Band Pass Filter allows harmonics at a set frequency to pass through the Filter, the harmonics above & below the set frequency do not pass through the Filter. Hence the name Band Pass Filter. The setting of these buttons is memorised with a Program.

Special- Button

When the special filter button is pressed the display shows:

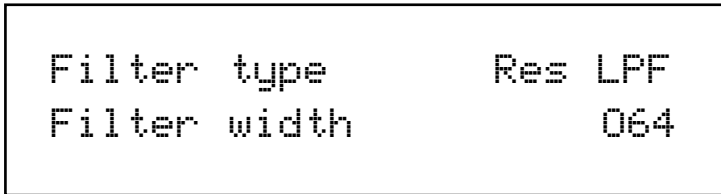

The higher parameter is "Filter type". In this case with a value of Res LPF. This parameter determines what type of Special filter is applied. Use the Higher data knob to adjust this parameter. There are 9 different special filters. Each one is made up of 2 filter blocks. The "Hyper Resonant" types are in series & are the Res LPF, Res BPF & Res HPF filters. These types are very resonant & the Filter width parameter allows the Cutoff frequencies of each filter block to be set at different frequencies. The rest of the filter types have the 2 filter blocks in parallel. Again the Filter width parameter allows the Cutoff frequencies of each filter block to be set at different frequencies. The range of this parameter is Res LPF, Res BPF, Res HPF, Notch, LPF + LPF, BPF + BPF, HPF + HPF, LPF + BPF & BPF + LPF. This parameter is memorised with a program.

The lower parameter is "Width". In this case with a value of 00. This parameter determines the spacing/offset in filter cutoff frequencies between the two elements of the "Special" filters. This is a duplicate of the Special type filter width parameter that is displayed on page 6 of the Filter menu. The reason for this is that it was found to be nice when editing for the display to jump back to this parameter when editing & as this parameter is duplicated in the Filter menu it will do that when the filter menu is selected. This can provide "Formant" type filters & speech like qualities can be easily realised. The Filter width is calibrated in semitones & allows specific offsets to be easily created. The range of this parameter is 000 to 127. Note that the Resonance modulation Knob in the Filter Modulation Matrix actually modulates the "Filter width" parameter & not the resonance when the "Special" filters are selected. The Resonance knob still retains its function as filter Resonance when in this mode. This parameter is memorised with a program.



NOTE:

Adjusting the value of this parameter will alter the value in the Filter menu. It is not possible to have different values set in the 2 pages.

Frequency - Knob

This knob controls the "Cutoff Frequency" of the Filter. Fully Clockwise & the Filters Cutoff frequency is set to the highest position, generally this produces a very trebly sound. Fully anticlockwise & the Filters Cutoff frequency is set to the lowest position, generally producing a very mellow sound. The range of this parameter is 000 to 127. This parameter is memorised with a Program.



NOTE:

It is possible to set the Filter so that it Filters out all of the sound. This normally happens at extreme settings. i.e. The Frequency knob set fully anticlockwise in Low Pass Filter mode or the Frequency knob set fully clockwise in the High Pass Filter mode.

Resonance - Knob

This knob controls the amount of Resonance the Filter has. The effect is to emphasise the harmonics around the Cutoff Frequency. (Set by the Frequency knob above.) For this reason on some synths this control is known as Emphasis. Fully anticlockwise there is no boosting of the Cutoff Frequency, but as you turn the knob clockwise this frequency will be boosted until fully clockwise it goes in to oscillation producing a new pitched element. (similar to feedback on an electric guitar) Increasing the Resonance is very good for bringing out modulation (movement or change) in the Filters Cutoff Frequency, such as TB303 basslines. The range of this parameter is 000 to 127. This parameter is memorised with a Program.

FILTER SECTION

Overdrive - Knob

This knob determines how much Overdrive is applied to the Filter. This can warm sounds up & give them a different harmonic content from the standard waveforms, "Warmer" sounds are produced by modelling the "Saturation effect" common in classic Analogue Filters. Fully anticlockwise the signal will be unaffected by the Overdrive. Fully clockwise & full drive will be applied. This parameters characteristics can be altered by the amount of mix level feed to the Filter. For really overdriven effects it is recommended that all the oscillators are used & maximum Mix levels are used. The range of this parameter is 000 to 127. This parameter is memorised with a Program.



NOTE:

The characteristics of the Overdrive can be altered quite drastically with the Overdrive curve parameter on page 5 of the Filter menu.

Filter Modulation Matrix

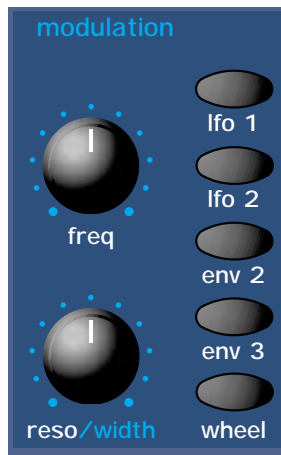

This is an extremely powerful feature of the Nova II keyboard. These controls affect the modulation of the Filter. The Buttons on the left are "Destinations". They can all be modulated by the "Sources" which are the buttons on the right. The amount of modulation applied from any source is determined by the setting of the Mod Depth Knob. This can be either positive modulation (Turning the Mod Depth Knob Clockwise) or negative modulation. (Turning the Mod Depth Knob Anticlockwise)

For example to adjust the level of Envelope 2 modulation of the the "Freq" setting of the Filter press the "Frequency" button to define the modulation destination, it will light up indicating it is selected. Press the Env 2 button to define the modulation source. Now adjusting the "Mod depth" knob clockwise will modulate the Frequency setting of the Filter by Envelope 2.



NOTE:

This makes it possible for *all* modulation sources to affect any one destination in varying amounts & even in different polarities.

The display will change to indicate the parameter that has been selected & display the newly edited value. The Display will stay like this until another parameter is adjusted, in which case it will change to display the new parameter. To return to the display of the Program / Performance name & number press the Program or Performance button.



NOTE:

Only one source & destination can be edited at one time.



NOTE:

Even though only one source & destination combination can be edited at one time, All available combinations can happen at the same time.

Possible Combinations & the effects Produced.



NOTE:

The range of all these parameters is -64 to +63. All these parameters are memorised with a Program.

**Frequency Mod- Knob
LFO 1 - Button**

This combination controls the amount of change to the Filter Cutoff Frequency (Initially set by the Frequency knob) by LFO 1. With the Frequency Mod knob set to the central position there is no change to the Filter Cutoff Frequency. Anticlockwise of centre there will be an increasing amount of *Negative* modulation. i.e. The Filter will be closed more by LFO 1. Clockwise of centre the modulation is *Positive*. i.e. The Filter will be increasingly opened by LFO 1.

**Frequency Mod- Knob
LFO 2 - Button**

This combination controls the amount of change to the Filter Cutoff Frequency (Initially set by the Frequency knob) by LFO 2. With the Frequency Mod knob set to the central position there is no change to the Filter Cutoff Frequency. Anticlockwise of centre there will be an increasing amount of *Negative* modulation. i.e. The Filter will be closed more by LFO 2. Clockwise of centre the modulation is *Positive*. i.e. The Filter will be increasingly opened by LFO 2.

**Frequency Mod- Knob
ENV 2 - Button**

This combination controls the amount of change to the Filter Cutoff Frequency (Initially set by the Frequency knob) by ENV 2. With the Frequency Mod knob set to the central position there is no change to the Filter Cutoff Frequency. Anticlockwise of centre there will be an increasing amount of *Negative* modulation. i.e. The Filter will be closed more by ENV 2. Clockwise of centre the modulation is *Positive*. i.e. The Filter will be increasingly opened by ENV 2.

**Frequency Mod- Knob
ENV 3 - Button**

This combination controls the amount of change to the Filter Cutoff Frequency (Initially set by the Frequency knob) by ENV 3. With the Frequency Mod knob set to the central position there is no change to the Filter Cutoff Frequency. Anticlockwise of centre there will be an increasing amount of *Negative* modulation. i.e. The Filter will be closed more by ENV 3. Clockwise of centre the modulation is *Positive*. i.e. The Filter will be increasingly opened by ENV 3.

**Frequency Mod- Knob
Wheel - Button**

This combination controls the amount of change to the Filter Cutoff Frequency (Initially set by the Frequency knob) by the Mod Wheel. With the Frequency Mod knob set to the central position there is no change to the Filter Cutoff Frequency. Anticlockwise of centre there will be an increasing amount of *Negative* modulation. i.e. The Filter will be closed more by the Mod Wheel. Clockwise of centre the modulation is *Positive*. i.e. The Filter will be increasingly opened by the Mod Wheel.

**Resonance/Width - Knob
LFO 1 - Button**

This combination controls the amount of change to the Resonance (Initially set by the Resonance knob) by LFO 1. With the Resonance Mod knob set to the central position there is no change to the Resonance. Anticlockwise of centre there will be an increasing amount of *Negative* modulation. i.e. The Filter will become less resonant by LFO 1. Clockwise of centre the modulation is *Positive*. i.e. The Filter will become more resonant by LFO 1.



NOTE:

When "Special" (which are all Dual Filters) Filter types are selected this parameter no longer modulates the Resonance of the Filters but the spacing or "Width" between the 2 Filters Cutoff frequencies.

FILTER SECTION

Resonance/Width - Knob **LFO 2 - Button**

This combination controls the amount of change to the Resonance (Initially set by the Resonance knob) by LFO 2. With the Resonance Mod knob set to the central position there is no change to the Resonance. Anticlockwise of centre there will be an increasing amount of *Negative* modulation. i.e. The Filter will become less resonant by LFO 2. Clockwise of centre the modulation is *Positive*. i.e. The Filter will become more resonant by LFO 2.



When "Special" (which are all Dual Filters) Filter types are selected this parameter no longer modulates the Resonance of the Filters but the spacing or "Width" between the 2 Filters Cutoff frequencies.

Resonance/Width - Knob **ENV 2 - Button**

This combination controls the amount of change to the Resonance (Initially set by the Resonance knob) by ENV 2. With the Resonance Mod knob set to the central position there is no change to the Resonance. Anticlockwise of centre there will be an increasing amount of *Negative* modulation. i.e. The Filter will become less resonant by ENV 2. Clockwise of centre the modulation is *Positive*. i.e. The Filter will become more resonant by ENV 2.



When "Special" (which are all Dual Filters) Filter types are selected this parameter no longer modulates the Resonance of the Filters but the spacing or "Width" between the 2 Filters Cutoff frequencies.

Resonance/Width - Knob **ENV 3 - Button**

This combination controls the amount of change to the Resonance (Initially set by the Resonance knob) by ENV 3. With the Resonance Mod knob set to the central position there is no change to the Resonance. Anticlockwise of centre there will be an increasing amount of *Negative* modulation. i.e. The Filter will become less resonant by ENV 3. Clockwise of centre the modulation is *Positive*. i.e. The Filter will become more resonant by ENV 3.



When "Special" (which are all Dual Filters) Filter types are selected this parameter no longer modulates the Resonance of the Filters but the spacing or "Width" between the 2 Filters Cutoff frequencies.

Resonance/Width - Knob **Wheel - Button**

This combination controls the amount of change to the Resonance (Initially set by the Resonance knob) by the Mod Wheel. With the Resonance Mod knob set to the central position there is no change to the Resonance. Anticlockwise of centre there will be an increasing amount of *Negative* modulation. i.e. The Filter will become less resonant by the Mod Wheel. Clockwise of centre the modulation is *Positive*. i.e. The Filter will become more resonant by the Mod Wheel.



When "Special" (which are all Dual Filters) Filter types are selected this parameter no longer modulates the Resonance of the Filters but the spacing or "Width" between the 2 Filters Cutoff frequencies.

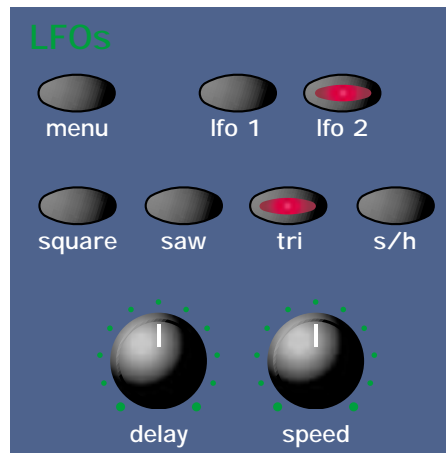

This section contains all the Knobs & buttons associated with the LFOs. The LFOs (Low Frequency Oscillators) produce regular electronic variation which are normally too low a frequency to be heard when converted into audio vibrations. However when used to modify various elements of the sound they can be used to create regular changes in pitch (Vibrato) or Pulse width & Filter Modulation. (these create tonal changes in the waveforms) for example.

Menu - Button

When this button is pressed a series of pages is available on the display containing parameters relevant to this section. In the LFO section there are 5 pages available. These are selected using the page Up & page Down buttons to the left of the display.

There are a maximum of 2 parameters displayed on any page. One for each line on the display. The upper & lower Data knobs on the right of the display are used to alter these parameter's values.

Page 1 looks like so:

Offset amount	000
Env 3 speed mod	+63

The higher parameter is "Offset amount". In this case with a value of 000.

This parameter controls an "Offset" (or DC shift) applied to the LFO waveform. This allows the creation of realistic Stringed instrument Vibrato effects by making it possible to create vibrato that is only up for example. Use the higher Dat knob to adjust this parameter. Fully Anticlockwise there is no effect on the normal operation of LFO 1. Tuning this knob clockwise of this position introduces an increasing amount of offset applied to the selected LFO's waveform until at fully clockwise the LFO's waveform is only in the upwards direction. The range of this parameter is 000 to 127. This parameter is memorised with a Program.

The lower parameter is "Env 3 speed mod". In this case with a value of +63.

This parameter determines how the Env 3 effects the speed of the selected LFO. In the central position of the lower Data knob there is no change to the selected LFO's speed. Anticlockwise of centre there will be an increasing amount of negative modulation. i.e. the selected LFO will slow down as the Envelope rises & speed back up as the envelope falls. Clockwise of centre there will be an increasing amount of positive modulation. i.e. the selected LFO will speed up as the Envelope rises & slow down as the envelope falls. The range of this parameter is -64 to +63. This parameter is memorised with a Program.

LFO SECTION

Page 2 looks like so:

MWh speed mod	+10
AT speed mod	+10

The higher parameter is "MWheel speed mod". In this case with a value of +10.

This parameter determines how the Mod Wheel effects the speed of the selected LFO. If this parameter is set to 0 there is no change to the selected LFO's speed. Negative values of this parameter will produce an increasing amount of negative modulation. i.e. the selected LFO will slow down as the Modulation Wheel is moved forward & speed back up as it is brought back. Positive values of this parameter will produce an increasing amount of positive modulation. i.e. the selected LFO will speed up as the Modulation Wheel is moved forward & slow down as it is brought back. The range of this parameter is -64 to +63. This parameter is memorised with a Program.

The lower parameter is "AT speed mod". In this case with a value of +10.

This parameter determines how the Aftertouch effects the speed of the selected LFO. If this parameter is set to 0 there is no change to the selected LFO's speed. Negative values of this parameter will produce an increasing amount of negative modulation. i.e. the selected LFO will slow down as the Aftertouch is applied & speed back up as it is disengaged. Positive values of this parameter will produce an increasing amount of positive modulation. i.e. the selected LFO will speed up as the Aftertouch is applied & slow down as it is disengaged. The range of this parameter is -64 to +63. This parameter is memorised with a Program.

Page 3 looks like so:

Sync	Off
LFO range	Slow

The higher parameter is "Sync". In this case with a value of 16th.

This parameter determines where the selected LFO get their Clock. Turning the upper Data knob fully anticlockwise selects the "Off" option which means the selected LFO is running on its own clock & is not in sync with anything else. Turning the knob clockwise from this position makes the selected LFO sync to Internal or External MIDI Clock in various signatures ranging from 12 Bars to 32nd Triplets. The range of this parameter is Off, 32 Triplet, 32nd, 16th Triplet, 16th, 8th Triplet, 16th Dotted, 8th, 4th Triplet, 8th Dotted, 4th, 2nd Triplet, 4th Dotted, 2nd, 1 Bar Triplet, 2nd Dotted, 1 Bar, 2 Bar Triplet, 1 Bar Dotted, 2 Bars, 4 Bar Triplet, 3 Bars, 5 Bar Triplet, 4 Bars, 3 Bar Dotted (4.5 Bars), 7 Bar Triplet, 5 Bars, 8 Bar Triplet, 6 Bars, 7 Bars, 5 Bar Dotted (7.5 Bars), 8 Bars, 6 Bar Dotted (9 Bars), 7 Bar Dotted (10.5 Bars) & 8 Bar Dotted (12 Bars). This parameter is memorised with a Program.

The lower parameter is "LFO range". In this case with a value of Slow.

This parameter is used to select the frequency range for the currently selected LFO. Use the lower Data knob to adjust this parameter. If Slow is selected the Speed knob of the selected LFO will have a range that goes from stopped to moderate speeds. If Normal is selected the Speed knob of the selected LFO will have a range equivalent to that found on a normal synthesiser. If Fast is selected the Speed knob of the selected LFO will have a range of stopped to several Khz. This parameter is memorised with a Program.

Page 4 looks like so:

Delay fade	In
Delay trigger	Multi

The higher parameter is "Delay fade". In this case with a value of In.

This parameter determines how the selected LFOs Delay parameter behaves. Turning the higher Data knob anticlockwise selects the "In" option which means if a Delay is set using the LFO Delay Knob then no modulation will be present at the start of the note but LFO modulation will "Fade in" over the Delay period. Turning the lower Data knob clockwise selects the "Out" option which

means if a Delay is set using the LFO Delay Knob then LFO modulation will be present at the start of the note & will "Fade out" over the Delay period. The range of this parameter is In & Out. This parameter is memorised with a Program.

The lower parameter is "Delay trigger". In this case with a value of Multi.

This parameter determines how the "Delay" parameter is triggered on the selected LFO. Turning the lower Data knob anticlockwise selects the "Multi" option which means the LFO Delay Time is reset to the start value every time any key is pressed. Turning the upper Data knob clockwise selects the "Single" option which means the LFO Delay Time is reset to the start value only if no other keys are currently held down. The range of this parameter is Multi & Single. This parameter is memorised with a program.

Page 5 looks like so:

Triggering	Keysync
LFO slew amount	000

The higher parameter is "Triggering". In this case with a value of Keysync.

This parameter determines how the selected LFO is triggered. Turning the higher Data knob anticlockwise selects the "Freewheel" option which means all the LFOs of the "Voices" that are being played are not in phase or in sync. This is the most natural sounding for vibrato effects etc. Turning the lower Data knob clockwise selects the "Keysynced" option which means all the LFOs of the "Voices" that are being played are in phase & the cycles of the LFOs are reset to start from the beginning when a new note is struck. The range of this parameter is Freewheel & Keysynced. This parameter is memorised with a Program.

The lower parameter is "LFO slew amount". In this case with a value of 000.

This parameter determines how fast the selected LFO can change to another value (a bit like portamento). Use the lower data knob to adjust this parameters value. In the 000 position (fully anticlockwise) no slewing is applied to the selected LFO & the LFO behaves normally. Turning the upper data knob introduces the slewing effect. The range of this parameter is 000 to 127. This parameter is memorised with a Program.

LFO 1 - Button

LFO 2 - Button

The LFO 1 & LFO 2 buttons select which LFO the Speed & Delay knobs are going to adjust. To adjust LFO 1 press the LFO 1 button. To adjust the LFO 2 press the LFO 2 button.

Delay - Knob

The Delay knob controls how long after the note is struck before the selected LFO begins to take effect. If the knob is fully anticlockwise the LFO will begin immediately. As the knob is turned clockwise it will take increasingly longer for the LFO effect to be introduced.



NOTE:

This is particularly useful for vibrato effects where if present as the note is struck, can make the note sound out of tune. Turning the Delay Knob slightly clockwise, selected LFO will not be introduced until after the note is struck, thereby removing the problem.



NOTE:

If you have problems getting the selected LFO to take effect, make sure the delay knob is not set fully clockwise.

Speed - Knob

The Speed knob controls the rate at which the selected LFO oscillates. Turning the Speed knob fully anticlockwise sets the LFO running at its slowest speed (which is actually stopped) & turning the Speed knob fully clockwise sets the LFO running at its highest speed. (Which can be KHz)

LFO SECTION

Square	-	Button
Saw	-	Button
Tri	-	Button
S/H	-	Button

These Buttons select which waveform the selected LFO has.

The Tri button selects a Triangle waveform. This waveform gives the smoothest, continuous change in level to the LFO & is therefore probably the most useful setting. When used in the Oscillator Section it gives you vibrato (if used at moderate speed & subtle amount) or "Siren" effects (if used at slow speeds & large amount) or FM type effects. (if used at high speed & subtle amount) If used with the Filter slow speeds produce Wah Wah effects.

The Saw button selects a Sawtooth waveform. This waveform looks like the teeth of a saw (from which it gets its name) & gives you a falling level which suddenly jumps back up to full level. When used in the Filter it produces a rhythmic pulsating effect, similar to a sequenced repeated bass line. When used in the Oscillator Section it can be used to create "Alarm" type sounds.

The Square button selects a waveform that looks square (from which it gets its name) & changes instantly from one level to another. This is useful for Trill & Computer Game effects.

The S/H button selects the Sample & Hold waveform. (sometimes called Random) At a regular interval (governed by the Speed knob) the level of the LFO jumps to a new random level & stays there until the next jump. This creates a rhythmic effect particularly if used on the Filter & assigned to the Cutoff Frequency. (refer Filter section on page 87 for details). Useful results can also be obtained when used in the Oscillator Section in the creation of Computer Game effects. The setting of these buttons are memorised with a Program.



Menu - Button

When this button is pressed a series of pages is available on the display containing parameters relevant to this section. In the Inputs section there is 1 page available.

There are a maximum of 2 parameters displayed on any page. One for each line on the display. The upper & lower Data knobs on the right of the display are used to alter these parameter's values.

Page 1 looks like so:

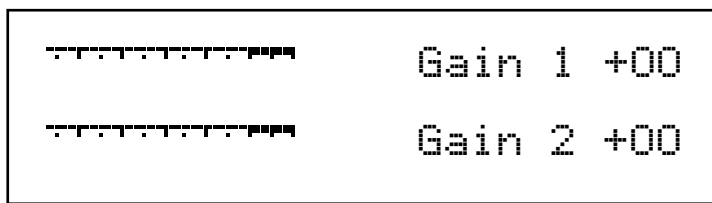

The inputs 1 & 2 can be monitored & the sensitivity of the inputs can be adjusted using this page. PPM meters show the level of both inputs. The levels of both of these signals can be adjusted from +60 dB gain to -8 dB attenuation using the upper & lower Data knobs. These parameters are memorised as Global.



NOTE:

The setting of these parameters is saved along with all the other Global parameters when the Global parameters are saved while in the Global menu.



NOTE:

A slight click may be heard a certain intervals as the gain is adjusted. This is due to switching of analogue circuits & is normal.

Constant Gate - Button

When this button is lit, the envelopes are constantly gated on as if C3 was being played constantly. This allows signals fed into the Inputs

(& that are assigned as Special waveforms to the Oscillators) to be passed through the Nova II keyboard's synthesis engine without requiring a MIDI Note message to trigger the envelopes. Also this feature can be used to create sustained sound effects that require no trigger note. When a Program that has this parameter activated is selected, the Program will sound straight away as if C3 was played. This will continue until another program is selected.

Setting up the Sensitivity/Input level of the Inputs.

Plug a sound source into one of the Nova II keyboard's Inputs. Adjust the sensitivity with The Gain Parameter on Page 1 of the inputs menu to the type of sound source connected. As a guideline in the -4 position the input sensitivity is suitable for accepting signals from Studio equipment such as Samplers, Synths, Workstations, Mixers etc. (+4dB) In the +10 position the sensitivity is suitable for Consumer Audio Equipment such as Cassette decks etc. (-10dB) In the + 25 position the sensitivity is suitable for guitars etc. (-25dB) In the +55 position the sensitivity is suitable for Microphones etc. (-55dB) These settings may vary from equipment to equipment. To set this correctly press the menu button in the Input section & go to page 1. The display looks like so:

INPUTS SECTION

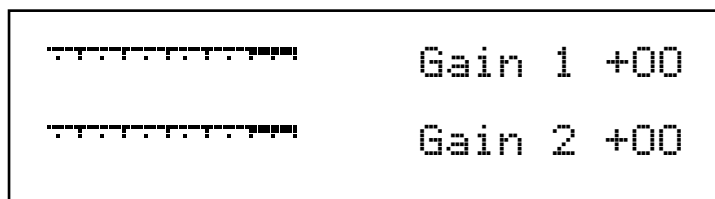

In this page meters are available showing the level of incoming signals on the 2 Inputs. The 2 Data knobs access "Gain" controls allowing -8dBm attenuation (a signal of =8dbm will clip) to +60dBm of boost or gain to the signal. When the meters reach the highest segment of the display the signal is clipping. Set the "Gain" controls to get the loudest possible signal without clipping.



NOTE:

The "Gain" can be set individually for each channel.

The Inputs on the Nova II keyboard can be used in 3 different ways, Firstly an Input can be used to "Tack on" to an effects chain in a Program or to the Effects chain of a Part of a Performance. Secondly as waveform that can be processed by the Filter, LFOs, ENVs & in turn the Effects. Thirdly as a Modulator or Carrier in a Vocoder setup. Lets look at these individually.

Setting the Inputs to be routed to the effects.

Set up the Input sensitivity with the "Gain" parameters as shown above. To connect an Input to an effects chain in Program or Performance mode simply press the menu button in the Effects section. Go to page 8 of the Effects sections Distort/EQ menu & set the "Pass to effects:" parameter to either Input 1 or 2 or Program & Input 1 or 2. Input 1 or 2 settings mean only the selected Input goes to the effects on the selected Program or Part & the sound assigned to the Program or Part is mute. Program & Input 1 or 2 settings mean that the selected Input & the sound assigned to the Program or Part go the effects. Remember there are 7 effects available in each program or Part so a lot of effects processing can be used on the Inputs. Additionally in a Performance the output of the effects can be routed to different output pairs allowing separate returns to be realised. To do this select the Part of the Performance you wish to re-route & set the Part outputs parameter on page 2 of the Output menu in the Part edit section to the output pair you require.

Passing an Input signal through the Filter & effects.

Passing loops & other signals through Filters has become popular over the last couple of years & the Nova II keyboard allows either Input to be processed in this way. Set up the Input sensitivity with the "Gain" parameters as shown above. Simply selecting the Program D125 Input/sw1 Program will assign Input one to an Oscillator & will therefore pass this signal through the Filter. Additionally this Program also uses the "Constant Gate" parameter meaning no MIDI event is required to trigger the envelopes. Alternatively you can set up your own Program.

To set this up it is necessary create a Program that is set up so that an Oscillator waveform is substituted with an Input signal & to supply a MIDI note to "trigger" the Envelopes (the Amp Envelope in particular) or set the Constant gate parameter to On so that you can hear the signal.

The best thing to do is to use B127 Init Prog as a starting point from which to create an "Input" Program. Select Prog B127 Init Prog. Select Oscillator 1 & then press the Mix button (so that it is lit) in the Oscillator Mod Matrix. Turn the Level knob in the Oscillator Mod Matrix fully clockwise to a value of 127. (This turns Osc 1 up to a volume of 127) Select Oscillator 2 & then press the Mix button (so that it is lit) in the Oscillator Mod Matrix. Turn the Level knob in the Oscillator Mod Matrix fully anticlockwise to a value of 000. (This turns Osc 2 down to a volume of 000) Select Oscillator 3 & then press the Mix button (so that it is lit) in the Oscillator Mod Matrix. Turn the Level knob in the Oscillator Mod Matrix fully anticlockwise to a value of 000. (This turns Osc 3 down to a volume of 000) Now the only audible Oscillator should be Oscillator 1. Select Oscillator 1 & then press the Special waveform button. Use the lower fast data knob to select the desired Input. Now when pressing a note on the Nova II keyboard the Input signal should be heard.

**NOTE:**

If no signal is present on the Input no sound will be heard.

**NOTE:**

If no MIDI note is sent to the Nova II keyboard & the Constant gate parameter is set to Off no sound will be heard & if no signal is present on the assigned Input at the moment the MIDI Note is played then no sound will be heard.

Now all that remains to be done is set up the Filter, Envelopes, LFOs & Effects to the type/settings that you require. Once that is done then save the Program so you can recall it later. Some cool things can be done here. Filter sweeps can be carried out by the envelopes. LFOs. LFOs of course can be synced to MIDI clock & used to Modulate the Oscillator Mix level thereby creating "Gater" effects. In an unsynced mode & with the LFO range parameter set to Fast strange effects can be achieved when "Gating" the Inputs at Khz (similar to Decimator type effects). Remember that Envelope 3 can also modulate the speed of the LFO that is used for the "Gating" effect.

**NOTE:**

Input choices are memorised with the program so different programs could use different Inputs or even both at once by using Oscillator 2 or 3 for the other Input.

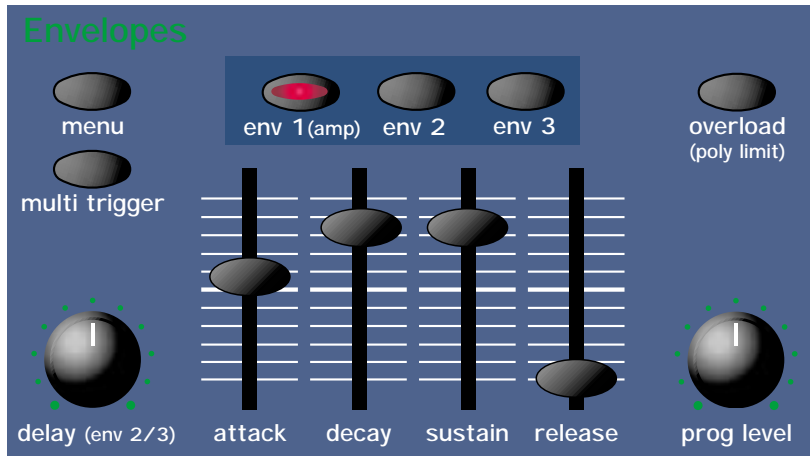

This section contains all the Knobs & buttons associated with the Envelopes. The Envelopes are used to shape a sound over time. Env 1 (the Amplifier Envelope) is assigned to the Amplifier & controls the Volume of the Program. It is used to decide how quickly the sound starts when you play a note & how it sustains & dies away. Similarly Env 2 & Env 3 can be used to create tonal changes over time by modulating the Filters Cutoff Frequency and/or Resonance in a similar fashion or can be used to create sweeping pitch shifts, Pulse Width Modulation, Sync & Osc Mix sweeps.

Menu - Button

When this button is pressed a series of pages is available on the display containing parameters relevant to this section.

In the Envelope section there are 13 pages available.

There are a maximum of 2 parameters displayed on any page. One for each line on the display. The upper & lower Data knobs on the right of the display are used to alter these parameter's values.

Page 1 looks like so:

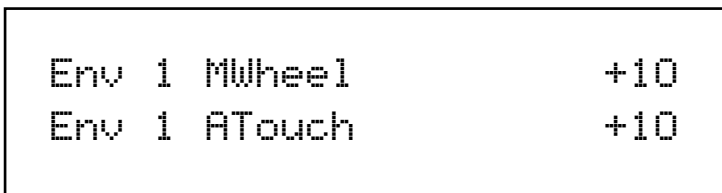

The lower parameter is "Env 1 MWheel". In this case with a value of +10.

This parameter controls the volume of the Program using the Mod Wheel. With the higher Data knob fully anticlockwise, the Mod Wheel alters the volume of the Program & it drops correspondingly. With the lower Data knob fully clockwise the Mod Wheel alters the volume of the Program gets louder correspondingly. The range of this parameter is -64 to +63. This parameter is memorised with a Program.

The higher parameter is "Env 1 ATouch". In this case with a value of +10.

This parameter controls the volume of the Program using the Aftertouch. With the upper Data knob fully anticlockwise when the Aftertouch is applied the volume of the Program drops correspondingly. With the upper Data knob fully clockwise when the Aftertouch is applied the volume of the Program gets louder correspondingly. The range of this parameter is -64 to +63. This parameter is memorised with a Program.

Page 2 looks like so:

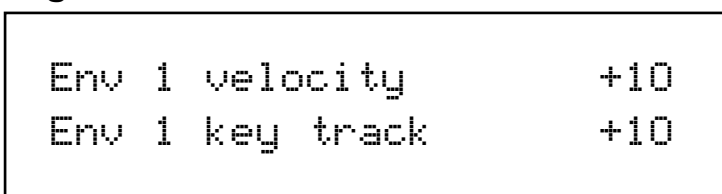

The lower parameter is "Env 1 velocity". In this case with a value of +10.

This parameter determines how the Velocity of the notes played on the keyboard affect the amount of modulation produced by Envelope 1. Use the higher Data knob to adjust this parameter. In the central position, (+00) there is no Velocity response to the

amount of modulation produced by the Envelope 1. Anticlockwise of centre, there will be an increasing amount of negative modulation. i.e. Envelope 1's amount of modulation will decrease when notes are struck harder (with more Velocity) on the keyboard. Clockwise of centre, there will be an increasing amount of positive modulation. i.e. Envelope 1's amount of modulation will increase when notes are struck harder (with more Velocity) on the keyboard. The range of this parameter is -64 to +63. These parameters are memorised with a Program.

The higher parameter is "Env 1 key track". In this case with a value of +10.

This parameter modulates the speed of the Attack, Decay & Release times of Envelope 1, depending on the key played on the keyboard. Use the lower Data knob to adjust this parameter. In the central position (+00) there is no modulation to Envelope 1. Anticlockwise of centre there will be an increasing amount of negative modulation. i.e. The speed of Envelope 1's Attack, Decay & Release times become shorter below C3 & longer above C3 on the keyboard. Clockwise of centre there will be an increasing amount of positive modulation. i.e. The speed of Envelope 1's Attack, Decay & Release times become longer below C3 & shorter above C3 on the keyboard. The range of these parameters is -64 to +63. These parameters are memorised with a Program.

Page 3 looks like so:

```

Env 1 lev track      +00
Env 1 lev note      C3
    
```

The higher parameter is "Env 1 level track". In this case with a value of +00.

In conjunction with the "Env 1 level note" parameter below these parameters control the amount of envelope modulation in relation to the note played on the keyboard. This is particularly useful when dealing with more complex FM synthesis. Use the higher Data knob to adjust this parameter. When this parameter is set to a +ve value the amount of modulation applied by the envelope increases as higher notes are played on the keyboard up to the setting of the "Env level note" parameter, at which point full modulation is applied. When this parameter is set to a -ve value the amount of modulation applied by the envelope decreases as higher notes are played on the keyboard from the setting of the "Env level note" parameter. Below are diagrams outlining the function.

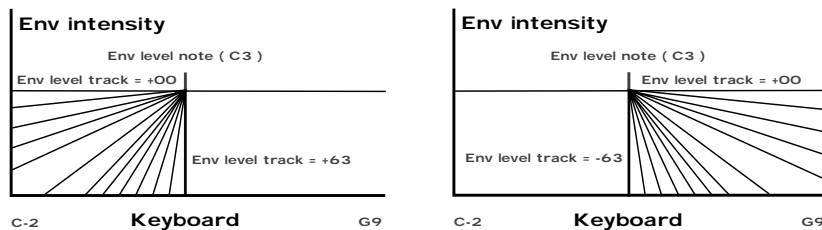

On the left a Env level note with a value of +00 produces no change in envelope level at different points along the keyboard. as +ve values are applied the start point of the fade in moves higher up the keyboard until with a value of +64 no envelope modulation occurs at B2 & all envelope modulation occurs at C3. On the right with -ve modulation the reverse happens.

This parameter is calibrated. Values -64 & -63 are the same & cause instant switch over at the Env level note value. The same applies to +64. The parameter is calibrated in semitone steps from + or - 62 to + or - 16. + or - 15, 14, 13 & 12 are calibrated at 3 semitones each. 11, 10, 9 & 8 are calibrated in 6 semitones each & 7, 6, 5 & 4 are calibrated in octaves. The remainder are equally tempered for the remainder of the range. The range of this parameter is -64 to +63. This parameter is memorised with a Program.

The lower parameter is "Env 1 level note". In this case with a value of +00.

In conjunction with the "Env 1 level track" parameter above these parameters control the amount of envelope modulation in relation to the note played on the keyboard. This is particularly useful when dealing with more complex FM synthesis. Use the lower Data knob to adjust this parameter. This parameter determines the point at which the "tracking" parameter above begins or stops. See the diagram above. The range of this parameter is C-2 to G9. This parameter is memorised with a Program.

Page 4 looks like so:

```

Env 1 A-D repeat    +22
    
```

ENVELOPES SECTION

The higher parameter is "Env 1 A-D repeat". In this case with a value of 022. This parameter controls the number of times the Attack/Decay cycles of the selected envelope repeat before entering the sustain phase of the envelope. With the higher Data knob fully anticlockwise (Value 000) Envelope 1 behaves as normal, triggering only once when a key is struck. When this parameter is set to a value of 1 or more the Attack/Decay cycles are looped correspondingly. At a value of 127 the Attack/Decay cycles loop infinitely as long as the key is held down. Below are diagrams illustrating this parameters behaviour:

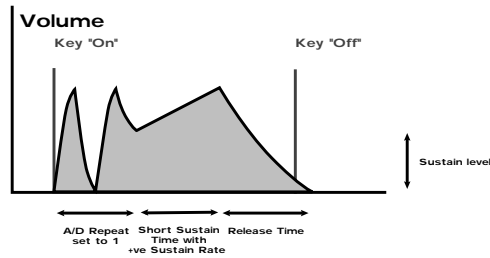

The range of this parameter is Off, 1 to 126 & Inf (Infinite). This parameter is memorised with a Program.

Page 5 looks like so:

```

Env 1 sust rate      +00
Env 1 sust time     C3
    
```

The higher parameter is "Env 1 sustain rate". In this case with a value of +00. This parameter is used to control the slope of the "Sustain" phase of the envelope. Use the higher Data knob to adjust this parameter. When this parameter is set to +00 the curve is normal. i.e. just like a normal ADSR envelope like so:

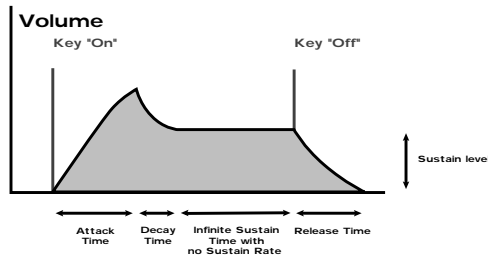

When this parameter has a +ve value, during the "Sustain" phase of the envelope the Sustain value will rise to full at a "Rate" determined by this parameter as can be seen below:

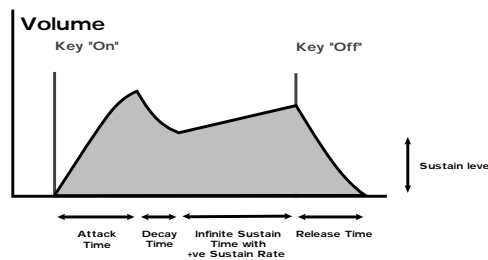

Low values like +01 will produce a very slow rise & high values will produce a quick rise to full intensity. When this parameter has a -ve value, during the "Sustain" phase of the envelope the Sustain value will fall to zero at a "Rate" determined by this parameter as can be seen below:

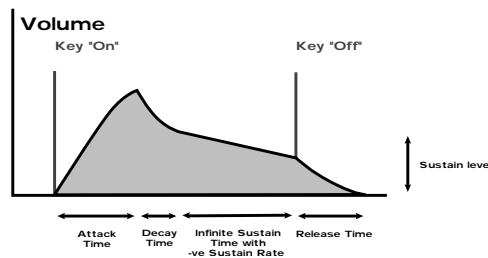

Low values like -01 will produce a very slow fall & high values will produce a quick fall to zero intensity. The range of this parameter is -64 to +63. This parameter is memorised with a Program.

The lower parameter is "Env 1 sustain time". In this case with a value of 000.

This parameter controls the length of time the "Sustain" phase of the envelope lasts. Use the lower Data knob to adjust this parameter. Full clockwise at a value of "Key" the sustain phase of the envelope behaves as any standard ADSR envelope. i.e. the sustain phase lasts until the key has been released, at which point the release phase starts. Any setting other than the Key setting defines a finite time duration for the sustain phase. If this is shorter than the duration that the key is held down then the release phase is started before the key is released. The range of this parameter is 000 to 126 & Key. This parameter is memorised with a Program.

Page 6 looks like so:

Env 2 velocity	+10
Env 2 key track	+10

The lower parameter is "Env 2 velocity". In this case with a value of +10.

This parameter determines how the Velocity of the notes played on the keyboard affect the amount of modulation produced by Envelope 2. Use the higher Data knob to adjust this parameter. In the central position, (+00) there is no Velocity response to the amount of modulation produced by the Envelope 2. Anticlockwise of centre, there will be an increasing amount of negative modulation. i.e. Envelope 2's amount of modulation will decrease when notes are struck harder (with more Velocity) on the keyboard. Clockwise of centre, there will be an increasing amount of positive modulation. i.e. Envelope 2's amount of modulation will increase when notes are struck harder (with more Velocity) on the keyboard. The range of this parameter is -64 to +63. These parameters are memorised with a Program.

The higher parameter is "Env 2 key track". In this case with a value of +10.

This parameter modulates the speed of the Attack, Decay & Release times of Envelope 2, depending on the key played on the keyboard. Use the lower Data knob to adjust this parameter. In the central position (+00) there is no modulation to Envelope 2. Anticlockwise of centre there will be an increasing amount of negative modulation. i.e. The speed of Envelope 2's Attack, Decay & Release times become shorter below C3 & longer above C3 on the keyboard. Clockwise of centre there will be an increasing amount of positive modulation. i.e. The speed of Envelope 2's Attack, Decay & Release times become longer below C3 & shorter above C3 on the keyboard. The range of these parameters is -64 to +63. These parameters are memorised with a Program.

Page 7 looks like so:

Env 2 lev track	+00
Env 2 lev note	C3

The higher parameter is "Env 2 level track". In this case with a value of +00.

In conjunction with the "Env 2 level note" parameter below these parameters control the amount of envelope modulation in relation to the note played on the keyboard. This is particularly useful when dealing with more complex FM synthesis. Use the higher Data knob to adjust this parameter. The operation of this parameter is identical to Env 1 level track parameter on page 3 but applies to Envelope 2. The range of this parameter is -64 to +63. This parameter is memorised with a Program.

The lower parameter is "Env 2 level note". In this case with a value of +00.

In conjunction with the "Env 2 level track" parameter above these parameters control the amount of envelope modulation in relation to the note played on the keyboard. This is particularly useful when dealing with more complex FM synthesis. Use the lower Data knob to adjust this parameter. The operation of this parameter is identical to Env 1 level note parameter on page 3 but applies to Envelope 2. The range of this parameter is C-2 to G9. This parameter is memorised with a Program.

Page 8 looks like so:

Env 2 A-D repeat	+22
------------------	-----

ENVELOPES SECTION

The higher parameter is "Env 2 A-D repeat". In this case with a value of 022.

This parameter controls the number of times the Attack/Decay cycles of the selected envelope repeat before entering the sustain phase of the envelope. The operation of this parameter is identical to Env 1 A-D repeat parameter on page 4 but applies to Envelope 2. The range of this parameter is Off, 1 to 126 & Inf (Infinite). This parameter is memorised with a Program.

Page 9 looks like so:

Env 2 sust rate	+00
Env 2 sust time	C3

The higher parameter is "Env 2 sustain rate". In this case with a value of +00.

This parameter is used to control the slope of the "Sustain" phase of the envelope. Use the higher Data knob to adjust this parameter. The operation of this parameter is identical to Env 1 sustain rate parameter on page 5 but applies to Envelope 2. The range of this parameter is -64 to +63. This parameter is memorised with a Program.

The lower parameter is "Env 2 sustain time". In this case with a value of 000.

This parameter controls the length of time the "Sustain" phase of the envelope lasts. Use the lower Data knob to adjust this parameter. The operation of this parameter is identical to Env 1 sustain time parameter on page 5 but applies to Envelope 2. The range of this parameter is 000 to 126 & Key. This parameter is memorised with a Program.

Page 10 looks like so:

Env 3 velocity	+10
Env 3 key track	+10

The lower parameter is "Env 3 velocity". In this case with a value of +10.

This parameter determines how the Velocity of the notes played on the keyboard affect the amount of modulation produced by Envelope 3. Use the higher Data knob to adjust this parameter. In the central position, (+00) there is no Velocity response to the amount of modulation produced by the Envelope 3. Anticlockwise of centre, there will be an increasing amount of negative modulation. i.e. Envelope 3's amount of modulation will decrease when notes are struck harder (with more Velocity) on the keyboard. Clockwise of centre, there will be an increasing amount of positive modulation. i.e. Envelope 3's amount of modulation will increase when notes are struck harder (with more Velocity) on the keyboard. The range of this parameter is -64 to +63. These parameters are memorised with a Program.

The higher parameter is "Env 3 key track". In this case with a value of +10.

This parameter modulates the speed of the Attack, Decay & Release times of Envelope 3, depending on the key played on the keyboard. Use the lower Data knob to adjust this parameter. In the central position (+00) there is no modulation to Envelope 3. Anticlockwise of centre there will be an increasing amount of negative modulation. i.e. The speed of Envelope 3's Attack, Decay & Release times become shorter below C3 & longer above C3 on the keyboard. Clockwise of centre there will be an increasing amount of positive modulation. i.e. The speed of Envelope 3's Attack, Decay & Release times become longer below C3 & shorter above C3 on the keyboard. The range of these parameters is -64 to +63. These parameters are memorised with a Program.

Page 11 looks like so:

Env 3 lev track	+00
Env 3 lev note	C3

The higher parameter is "Env 3 level track". In this case with a value of +00.

In conjunction with the "Env 3 level note" parameter below these parameters control the amount of envelope modulation in relation to the note played on the keyboard. This is particularly useful when dealing with more complex FM synthesis. Use the higher Data knob to adjust this parameter. The operation of this parameter is identical to Env 1 level track parameter on page 3 but applies to Envelope 2. The range of this parameter is -64 to +63. This parameter is memorised with a Program.

The lower parameter is "Env 3 level note". In this case with a value of +00.

In conjunction with the "Env 3 level track" parameter above these parameters control the amount of envelope modulation in relation to the note played on the keyboard. This is particularly useful when dealing with more complex FM synthesis. Use the lower Data knob to adjust this parameter. The operation of this parameter is identical to Env 1 level note parameter on page 3 but applies to Envelope 2. The range of this parameter is C-2 to G9. This parameter is memorised with a Program.

Page 12 looks like so:

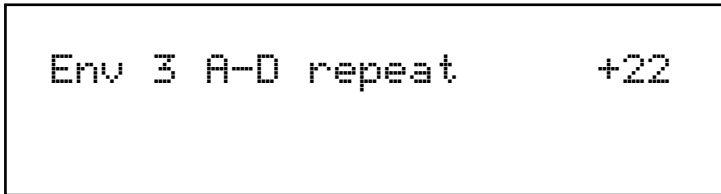

The higher parameter is "Env 3 A-D repeat". In this case with a value of 022.

This parameter controls the number of times the Attack/Decay cycles of the selected envelope repeat before entering the sustain phase of the envelope. The operation of this parameter is identical to Env 1 A-D repeat parameter on page 4 but applies to Envelope 2.

The range of this parameter is Off, 1 to 126 & Inf (Infinite). This parameter is memorised with a Program.

Page 13 looks like so:

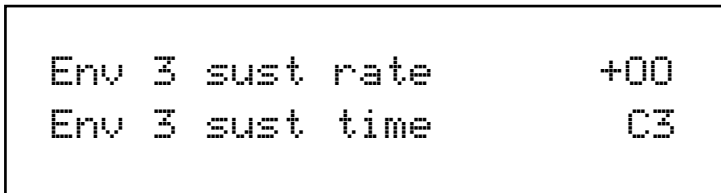

The higher parameter is "Env 3 sustain rate". In this case with a value of +00.

This parameter is used to control the slope of the "Sustain" phase of the envelope. Use the higher Data knob to adjust this parameter. The operation of this parameter is identical to Env 1 sustain rate parameter on page 5 but applies to Envelope 2. The range of this parameter is -64 to +63. This parameter is memorised with a Program.

The lower parameter is "Env 3 sustain time". In this case with a value of 000.

This parameter controls the length of time the "Sustain" phase of the envelope lasts. Use the lower Data knob to adjust this parameter. The operation of this parameter is identical to Env 1 sustain time parameter on page 5 but applies to Envelope 2. The range of this parameter is 000 to 126 & Key. This parameter is memorised with a Program.

ENV 1 - Button

ENV 2 - Button

ENV 3 - Button

These buttons select which Envelope this set of knobs & buttons is going to adjust.

Multi Trigger - Button (ENV 2/3)

Multi Trigger - Button (ENV 1)

These buttons determine how the Envelopes 1, 2 & 3 trigger. When a Multi trigger is activated (the button is lit) the triggering for the envelopes is in "Multi" mode & any new note received will retrigger the envelope. When Multi trigger is disabled (the button is unlit) the triggering for the envelopes is in "Single" mode triggering & there must be a gap in-between received notes for the envelope to retrigger. (Legato notes will not retrigger the envelope) The range of this parameter is On (Multi) or Off (Single). This parameter is memorised with a Program.

Delay - Knob (ENV 2/3)

This parameter introduces a Delay time before the selected Envelope starts when a note is struck on the keyboard. Turning this knob fully anticlockwise sets no delay. i.e. The selected Envelope will start immediately when a note is struck on the keyboard. turning this knob clockwise will introduce an increasing amount delay before selected Envelope starts after a note has been struck on the keyboard. The range of this parameter is Off, 1 to 127. This parameter is memorised with a Program.



This parameter only applies to Envelopes 2 & 3. It has no effect on Envelope 1.

Attack - Slider (All Envelopes)

This slider sets how quickly the Envelope rises to its maximum level when a note is struck. Set to 000, this is instantaneous increasing exponentially to 20 seconds when set to 127. The range of this parameter is 000 to 127. This parameter is memorised with a Program.

Decay - Slider (All Envelopes)

This slider sets how quickly the Envelope drops off to the Sustain level once the Maximum level has been reached by the Attack time. Set to 000, this is instantaneous increasing exponentially to 20 seconds when set to 127. The range of this parameter is 000 to 127. This parameter is memorised with a Program.

Sustain - Slider (All Envelopes)

This slider sets the level at which the Envelope remains at after the Decay phase until the note is released. Set to 000 the Envelope will decay all the way to zero without being interrupted. As the slider is moved higher, the level at which the Decay is halted increases until at 127 there is no Decay at all. The range of this parameter is 000 to 127. This parameter is memorised with a Program.



The envelope may appear to start decaying even though the note is being held due to the Sustain time parameter for the currently selected envelope.



The envelope may appear to rise or fall in the sustain phase depending on the setting of the Sustain rate parameter for the currently selected envelope.

Release - Slider (All Envelopes)

This slider sets how quickly the Envelope drops from the Sustain level to zero once the note has been released. Set to 000, this is instantaneous increasing exponentially to 20 seconds when set to 127. The range of this parameter is 000 to 127. This parameter is memorised with a Program.

Overload / Poly Limit - Button

This button indicates if the Program level is too high & will light if the currently selected Program is Clipping (Overloading). This is handy when adjusting the Program level parameter. When pressed & held down the button will light when the polyphony for the Nova II keyboard is exceeded. This is handy for establishing if overvoicing is occurring. This is best done by pressing the side of the button so that the light can be clearly observed.

Prog Level - Knob (ENV 1)

This parameter determines the overall level of the currently selected program. With 3 Oscillators set at high levels, Filter overdrive set high & large amounts of resonance, combined with large amounts of notes played can overload the signal path (Just like a mixing desk) This parameter allows the "Gain" of the whole signal path to be set so that distortion does not occur. In fact this parameter should be thought of as the "Gain" or "Trim" pot similar to that found on mixing consoles. Overload is indicated by the Clip / Poly button in the same section. range of these parameters is 000 to 127. This parameter is memorised with a Program.

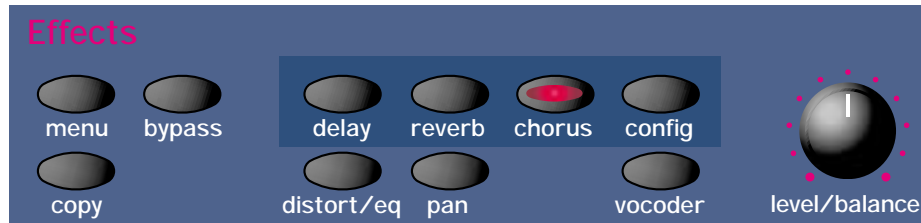

This section contains all the Knobs & buttons associated with the Effects Section. There are 7 effects available on each Program in the Nova II Keyboard.

Delay	-	Button
Reverb	-	Button
Chorus	-	Button
Config	-	Button
Distort/EQ	-	Button
Pan	-	Button
Vocoder	-	Button

These buttons select the effect that will assigned to the Level/Balance knob and which set of effects parameters will be displayed when the Menu button is pressed. i.e. If the Delay button is pressed (lit) the the Level/Balance knob controls the amount of Delay and the Delay parameters are displayed when the menu button is pressed, similarly if the Reverb button is pressed (lit) then the Level/Balance knob controls the amount of Reverb and the Reverb parameters are displayed when the menu button is pressed. etc. etc.

Level/Balance - Knob

This knob controls the amount of effect that is currently selected in the effects section. i.e. If the Delay button is pressed (lit) the the effect knob controls the amount of Delay, similarly if the Reverb button is pressed (lit) then the effect knob controls the amount of Reverb. etc. etc. Fully anticlockwise no effect will be heard and as the knob is rotated clockwise more and more effect is added. When the Config button is selected the knob controls the type of Effects Configuration. Refer to page 111 for details on Effects Configurations. When the Vocoder button is selected the knob controls the balances between the Carrier, Modulator and Vocoder output signals. At a position of 000 the Program (Carrier) only will be heard. Turning the knob to the mid position will fade this into the Vocoder's output. At the Mid position only the Vocoder's output will be heard. Tuning the knob clockwise from the mid position fades out the Vocoder's output and fades in the Modulator's signal. At the fully clockwise position only the Modulator will be heard. The range of these parameters is 000 to 127. This parameter is memorised with a Program in Program Mode or memorised with a Program or Performance in Performance Mode depending on the value of the Part's "Effects Used" parameter.



NOTE:

Setting the Vocoder balance to anything other than 000 activates the Vocoder.



NOTE:

When a Performance or Program that the Vocoder activated, "[V]" will appear after the Performance or Program name.

Menu - Button & Delay - Button

When these buttons are pressed, a series of pages is available on the display containing parameters relevant to this section. In the Delay section there are 4 pages available. These are selected using the page Up & page Down buttons to the left of the display.

There are a maximum of 2 parameters displayed on any page. One for each line on the display. The upper & lower Data knobs on the right of the display are used to alter these parameter's values.

Page 1 looks like so:

Delay time	010
Feedback	020

The higher parameter is "Delay time". In this case with a value of 010.

This parameter determines the Delay time of this effect. Use the higher Data knob to adjust this parameter. The range of this parameter is 00 to 127. This parameter is memorised with a Program in Program Mode or memorised with a Program or Performance in Performance Mode depending on the value of the Part's "Part FX" parameter.



If the Sync (Delay) parameter is set to anything but "Off", this parameter will not work.

The lower parameter is "Feedback". In this case with a value of 20.

This parameter determines how much feedback there is in the Delay effect. Use the lower Data knob to adjust this parameter. The higher the value of this parameter the more "Repeats" are in the delayed signal. The range of this parameter is 000 to 127. This parameter is memorised with a Program in Program Mode or memorised with a Program or Performance in Performance Mode depending on the value of the Part's "Part FX" parameter.

Page 2 looks like so:

Stereo width	010
Delay ration	1:1

The higher parameter is "Stereo width". In this case with a value of 010.

This parameter determines how wide the stereo image of the delay is. Use the upper Data knob to adjust this parameter. In the 000 position the Delay is Mono. In the 127 position the delay is fully stereo. The range of this parameter is 000 to 127. This parameter is memorised with a Program in Program Mode or memorised with a Program or Performance in Performance Mode depending on the value of the Part's "Part FX" parameter.

The lower parameter is "Delay ratio". In this case with a value of 1:1.

This parameter determines the relationship of the Delay times in the Delay. In the 1:1 position the Left & Right channel Delays are the same Delay time. In the 1:0.5 position the Right Delay is half the time of the Left Delay. In the 0.5:1 position the Left Delay is half the time of the Right Delay. The range of this parameter is 1:1, 1:0.75, 0.75:1, 1:0.66, 0.66:1, 1:0.5, 0.5:1, 1:0.33, 0.33:1, 1:0.25 & 0.25:1, . This parameter is memorised with a Program in Program Mode or memorised with a Program or Performance in Performance Mode depending on the value of the Part's "Part FX" parameter.

Page 3 looks like so:

Sync	32nd triplet
Delay HF damp	020

The higher parameter is "Sync". In this case with a value of 32nd Triplet.

This parameter determines if the delay is synchronised to MIDI Clock or not & at what resolution. Use the upper Data knob to adjust this parameter. Turning the upper Data knob fully anticlockwise selects the "Off" option which means the Delay is running on its own clock & is not in sync with anything else. Turning the knob clockwise from this position makes the Delay sync to Internal or External MIDI Clock in various signatures ranging from 12 Bars to 32nd Triplets. The range of this parameter is Off, 32 Triplet, 32nd, 16th Triplet, 16th, 8th Triplet, 16th Dotted, 8th, 4th Triplet, 8th Dotted, 4th, 2nd Triplet, 4th Dotted, 2nd, 1 Bar Triplet, 2nd Dotted, 1 Bar, 2 Bar Triplet, 1 Bar Dotted, 2 Bars, 4 Bar Triplet, 3 Bars, 5 Bar Triplet, 4 Bars, 3 Bar Dotted (4.5 Bars), 7 Bar Triplet, 5 Bars, 8 Bar Triplet, 6 Bars, 7 Bars, 5 Bar Dotted (7.5 Bars), 8 Bars, 6 Bar Dotted (9 Bars), 7 Bar Dotted (10.5 Bars) & 8 Bar Dotted (12 Bars). This parameter is memorised with a Program in Program Mode or memorised with a Program or Performance in Performance Mode depending on the value of the Part's "Part FX" parameter.



If this parameter is set to anything but "Off", the Delay Time parameter will not work.

The lower parameter is "Delay HF damp". In this case with a value of 20.

This parameter determines the rate at which High Frequencies decay away in repeats of the Delay. Use the lower Data knob to adjust this parameter. The range of this parameter is 000 to 127. This parameter is memorised with a Program in Program Mode or memorised with a Program or Performance in Performance Mode depending on the value of the Part's "Part FX" parameter.

Page 4 looks like so:

Delay wheel	+20
-------------	-----

The higher parameter is "Delay Wheel". In this case with a value of +20.

This parameter determines how much the Mod Wheel controls the amount of Delay effect. Use the upper Data knob to adjust this parameter. Fully anticlockwise, the Delay will be reduced with full modulation of the Mod Wheel. Fully clockwise, the Delay will be increased with full modulation of the Mod Wheel. The range of this parameter is -64 to +63. This parameter is memorised with a Program in Program Mode or memorised with a Program or Performance in Performance Mode depending on the value of the Part's "Part FX" parameter.

Menu - Button & Reverb - Button

When these buttons are pressed, a series of pages is available on the display containing parameters relevant to this section. In the Reverb section there are 3 pages available. These are selected using the page Up & page Down buttons to the left of the display.

There are a maximum of 2 parameters displayed on any page. One for each line on the display. The upper & lower Data knobs on the right of the display are used to alter these parameter's values.

Page 1 looks like so:

Type	Medium type 2
Early ref level	6

The higher parameter is "Type". In this case with a value of Medium type 2.

This parameter determines the type of Reverb effect. Use the higher Data knob to adjust this parameter. There are 16 different types of reverb available in the Nova II keyboard. Turning this knob fully anticlockwise selects Gated reverse reverb. This is a special reverb where the reverb builds to a point & then stops as opposed to decaying away like normal reverb. Turning this knob clockwise one click selects Gated rising, Again this is a gated type of reverb that is slightly reverse in characteristic. Turning this knob clockwise one click selects Gated gentle which is a classic gated sort of reverb. Turning this knob clockwise one click selects Gated falling which is a gated type of reverb but does decay away slightly like normal reverb. Turning this knob clockwise one click selects Dry chamber. This is the first of the normal reverb types & represents a very small room. The rest of the reverbs model rooms that gradually get bigger & bigger, the last one being Large plate 2. The range of this parameter is Gated reverse, Gated rising, Gated gentle, Gated falling, Dry chamber, Echo chamber, Small room, Big room, Medium type 1, Medium type 2, Medium plate 1, Medium plate 2, Large type 1, Large type 2, Large plate 1 & Large plate 2. This parameter is memorised with a Program in Program Mode or memorised with a Program or Performance in Performance Mode depending on the value of the Part's "Part FX" parameter.

The lower parameter is "Early ref level". In this case with a value of 6.

This parameter determines the level of early reflections in the reverb. Use the lower Data knob to adjust this parameter. The range of this parameter is 0 to 7. This parameter is memorised with a Program in Program Mode or memorised with a Program or Performance in Performance Mode depending on the value of the Part's "Part FX" parameter.

Page 2 looks like so:

Reverb decay	083
Reverb HF damp	020

The higher parameter is "Early ref level". In this case with a value of 6. This parameter determines the rate at which the Reverb effect decays away. Use the higher Data knob to adjust this parameter. The range of this parameter is 000 to 127. This parameter is memorised with a Program in Program Mode or memorised with a Program or Performance in Performance Mode depending on the value of the Part's "Part FX" parameter.

The lower parameter is "HF damp". In this case with a value of 020. This parameter determines the rate at which High Frequencies decay away in the Reverb & is called High Frequency Damping. Use the lower Data knob to adjust this parameter. The range of this parameter is 000 to 127. This parameter is memorised with a Program in Program Mode or memorised with a Program or Performance in Performance Mode depending on the value of the Part's "Part FX" parameter.

Page 3 looks like so:

Reverb wheel	+20
--------------	-----

The higher parameter is "Reverb wheel". In this case with a value of +50. This parameter determines How much the Mod Wheel controls the amount of Reverb effect. Use the upper Data knob to adjust this parameter. Fully anticlockwise the Reverb will be reduced with full modulation of the Mod Wheel, fully clockwise the Reverb will be increased with full modulation of the Mod Wheel. The range of this parameter is -64 to +63. This parameter is memorised with a Program in Program Mode or memorised with a Program or Performance in Performance Mode depending on the value of the Part's "Part FX" parameter.

Menu - Button & Chorus - Button

When these buttons are pressed, a series of pages is available on the display containing parameters relevant to this section. In the Rotary Speaker/Ensemble/Chorus/Flanger/Phaser section there are 6 pages available. These are selected using the page Up & page Down buttons to the left of the display. There are a maximum of 2 parameters displayed on any page. One for each line on the display. The upper & lower Data knobs on the right of the display are used to alter these parameter's values.

Page 1 looks like so:

Type	Quad chorus
Speed	027

The higher parameter is "Mod depth". In this case with a value of 032. This parameter adjusts the type of effect the Rotary Speaker/Ensemble/Chorus/Flanger/Phaser will be. Use the higher Data knob to adjust this parameter. The range of this parameter is Phaser, Chorus/Flanger, Quad Chorus, Ensemble & Rotary Speaker. This parameter is memorised with a Program in Program Mode or memorised with a Program or Performance in Performance Mode depending on the value of the Part's "Part FX" parameter.

The lower parameter is "Speed". In this case with a value of 027. This parameter determines the speed of the Rotary Speaker/Ensemble/Chorus/Flanger/Phaser LFO. Use the lower Data knob to adjust this parameter. The range of this parameter is 000 to 127. This parameter is memorised with a Program in Program Mode or memorised with a Program or Performance in Performance Mode depending on the value of the Part's "Part FX" parameter.

Page 2 looks like so:

Mod depth	032
Feedback	+00

The higher parameter is "Mod depth". In this case with a value of 032.

This parameter determines the depth of Rotary Speaker/Ensemble/Chorus/Flanger/Phaser LFO Modulation to the delay time of the Chorus. Higher values tend to sound a bit wobbly. Use the upper Data knob to adjust this parameter. The range of this parameter is 000 to 127. This parameter is memorised with a Program in Program Mode or memorised with a Program or Performance in Performance Mode depending on the value of the Part's "Part FX" parameter.

The lower parameter is "Feedback". In this case with a value of 00.

This parameter determines the amount of Feedback within the Rotary Speaker/Ensemble/Chorus/Flanger/Phaser. Use the lower Data knob to adjust this parameter. The range of this parameter is -64 to +63. This parameter is memorised with a Program in Program Mode or memorised with a Program or Performance in Performance Mode depending on the value of the Part's "Part FX" parameter.

Page 3 looks like so:

Delay	032
LFO waveshape	-20

The higher parameter is "Delay". In this case with a value of 032.

This parameter determines the delay time used by the Rotary Speaker/Ensemble/Chorus/Flanger/Phaser. Use the upper Data knob to adjust this parameter. The range of this parameter is 000 to 127. This parameter is memorised with a Program in Program Mode or memorised with a Program or Performance in Performance Mode depending on the value of the Part's "Part FX" parameter.

The lower parameter is "LFO waveshape". In this case with a value of -20.

This parameter determines the shape of the LFO waveform. Use the lower Data knob to adjust this parameter. The range of this parameter is -64 to -25, Sine, -23 to +23, Tri, +25 to +63. This parameter is memorised with a Program in Program Mode or memorised with a Program or Performance in Performance Mode depending on the value of the Part's "Part FX" parameter.

Page 4 looks like so:

Speed 2	080
Inertia	032

The higher parameter is "Speed 2". In this case with a value of 080.

This parameter determines the secondary Speed of the Rotary Speaker/Ensemble/Chorus/Flanger/Phaser. The primary speed is determined by the Speed knob on the front panel. It is possible to switch from the front panel setting to this one using the Wheel function & Wheel level parameters on page 6 of this menu. This is particularly effective when using the Rotary Speaker effect but is also applicable to all th effects on the Rotary Speaker/Ensemble/Chorus/Flanger/Phaser block. Use the upper Data knob to adjust this parameter. The range of this parameter is 000 to 127. This parameter is memorised with a Program in Program Mode or memorised with a Program or Performance in Performance Mode depending on the value of the Part's "Part FX" parameter.

The lower parameter is "Inertia". In this case with a value of 032.

This parameter determines rate at which the speed changes when the effect is switched from the primary speed to speed 2 & vice versa. This again is particularly effective when using the Rotary Speaker effect but is also applicable to all th effects on the Rotary Speaker/Ensemble/Chorus/Flanger/Phaser block. Use the lower Data knob to adjust this parameter. The range of this parameter is 000 to 127. This parameter is memorised with a Program in Program Mode or memorised with a Program or Performance in Performance Mode depending on the value of the Part's "Part FX" parameter.

Page 5 looks like so:

Stereo width	032
--------------	-----

The parameter is "Stereo width". In this case with a value of 032.

This parameter determines how stereo the effect is. Use the upper Data knob to adjust this parameter. With a value of 000 the effect is Mono. With a value of 127 the effect very stereo The range of this parameter is 000 to 127. This parameter is memorised with a Program in Program Mode or memorised with a Program or Performance in Performance Mode depending on the value of the Part's "Part FX" parameter.

Page 6 looks like so:

Wheel mode	Threshold
Wheel level	010

The higher parameter is "Wheel mode". In this case with a value of Threshold.

This parameter determines what the Mod Wheel is assigned to do. Use the upper Data knob to adjust this parameter. When this parameter is set to FX amount the Mod wheel will control the amount of effect if the "Wheel Level" parameter below is set to any value other than 000. When this parameter is set to Threshold then the Mod wheel controls the speed of the Rotary Speaker/Ensemble/Chorus/Flanger/Phaser effect. For example if this parameter is set to Threshold & the Wheel level parameter is set to 010 as shown, when the Mod wheel is set to any value between 000 & 009 then the Rotary Speaker/Ensemble/Chorus/Flanger/Phaser effect will be modulated at the front panel Speed setting. When the Mod wheel is set to any value between 010 & 127 then the Rotary Speaker/Ensemble/Chorus/Flanger/Phaser effect will be modulated at the Speed 2 parameters setting. The range of this parameter is FX amount & Threshold. This parameter is memorised with a Program in Program Mode or memorised with a Program or Performance in Performance Mode depending on the value of the Part's "Part FX" parameter.



NOTE:

The value of Speed 2 can be higher than the front panel Speed so that as the threshold is passed the effect will "Speed up", but also the reverse can apply, the Speed 2 can be lower than the front panel Speed so that as the threshold is passed the effect will "Slow down".

The lower parameter is "Wheel level". In this case with a value of 010.

This parameter determines how much the Mod Wheel controls the amount of Rotary Speaker/Ensemble/Chorus/Flanger/Phaser effect or the Threshold at which the speed of the Rotary Speaker/Ensemble/Chorus/Flanger/Phaser effect is switched over depending on the value of the "Wheel mode" parameter above. Use the lower Data knob to adjust this parameter. When the "Wheel mode" parameter above is set to FX amount setting this parameter to -ve values means the Rotary Speaker/Ensemble/Chorus/Flanger/Phaser effect will be reduced with full modulation of the Mod Wheel, setting this parameter to +ve values means the Rotary Speaker/Ensemble/Chorus/Flanger/Phaser effect will be increased with full modulation of the Mod Wheel. The range of this parameter when the Wheel mode parameter above is set to FX amount is -64 to +63. When the "Wheel

mode" parameter above is set to Threshold setting this parameter to a value of 010 means when the Mod wheel is set to any value between 000 & 009 then the Rotary Speaker/Ensemble/Chorus/Flanger/Phaser effect will be modulated at the front panel Speed setting. When the Mod wheel is set to any value between 010 & 127 then the Rotary Speaker/Ensemble/Chorus/Flanger/Phaser effect will be modulated at the Speed 2 parameters setting.. The range of this parameter when the Wheel mode parameter above is set to Threshold is 000 to 127. This parameter is memorised with a Program in Program Mode or memorised with a Program or Performance in Performance Mode depending on the value of the Part's "Part FX" parameter.

Config - Button & Level/Balance - Knob

When the Config button is selected, (lit) the Level/Balance knob changes the order/arrangement of the Delay, Reverb & Rotary Speaker/Ensemble/Chorus/Flanger/Phaser effects. Different configurations can make the effects sound quite different. i.e. a sound that is delayed then reverbed & then chorused sounds quite different to a sound that has been Chorused then Delayed then Reverbed. There are 19 different effects configurations available in the Nova II keyboard. Below is a diagram showing how the "Normal" effects configuration.

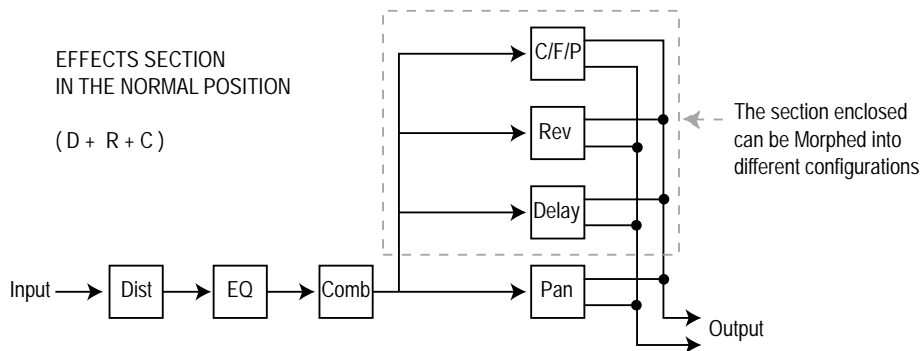

Below are diagrams showing how the different effects are connected in different configurations.

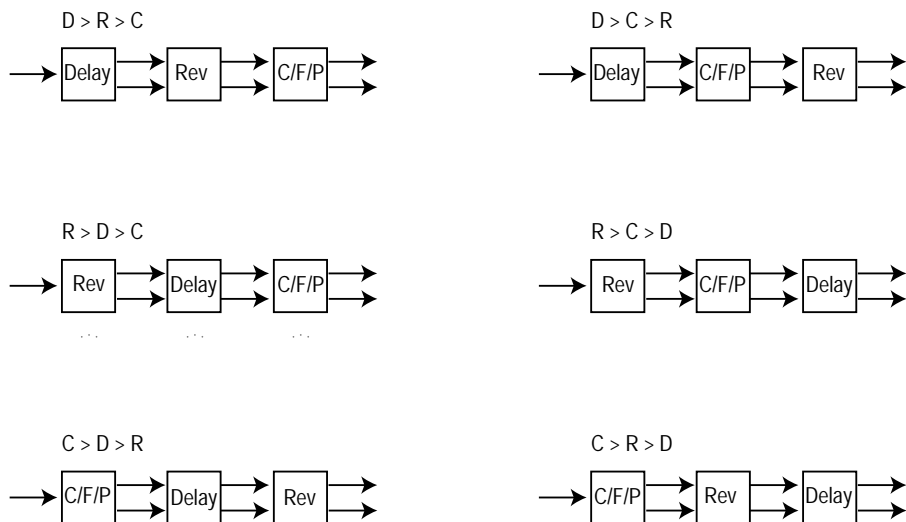

SERIES/PARALELL CONFIGURATIONS

$D + [R > C]$

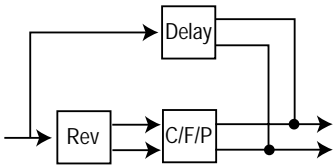

$D + [C > R]$

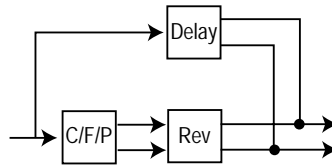

$R + [D > C]$

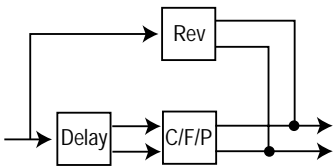

$R + [C > D]$

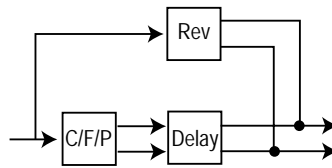

$C + [D > R]$

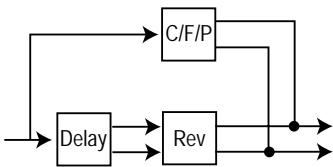

$C + [R > D]$

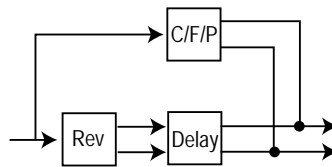

$D > [R + C]$

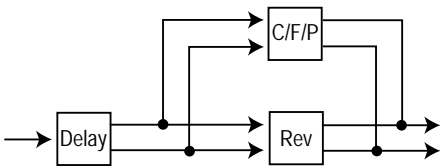

$R > [D + C]$

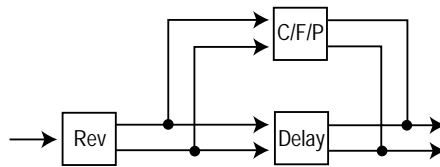

$C > [D + R]$

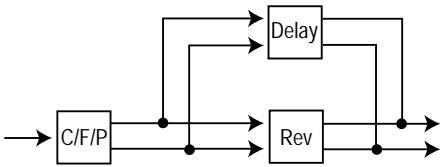

$[R + C] > D$

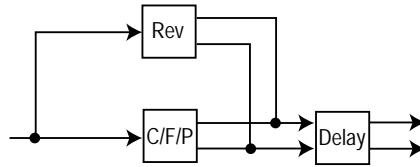

$[D + C] > R$

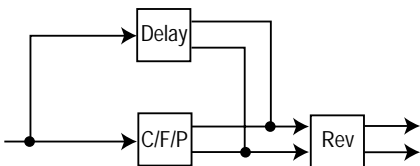

$[D + R] > C$

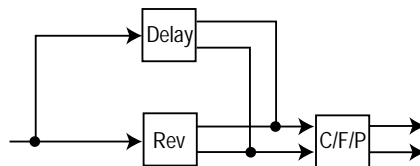

The range of this parameter is D+R+C, D>R>C, D>C>R, R>D>C, R>C>D, C>D>R, C>R>D, D+[R>C], D+[C>R], R+[D>C], R+[C>D], C+[D>R], C+[R>D], D>[R+C], R>[D+C], C>[D+R], [R+C]>D, [D+C]>R & [D+R]>C. This parameter is memorised with a Program in Program Mode or memorised with a Program or Performance in Performance Mode depending on the value of the Part's "Part FX" parameter.



NOTE:

To use the different configurations, the Config morph parameter should be set to 127. If this parameter is set to 000, the "Normal" configuration D+R+C applies.

Menu - Button & Config - Button

When these buttons are pressed a page is available on the display containing parameters relevant to this section.

In the Distort/EQ section there are 1 page available.

There are a maximum of 2 parameters displayed on any page. One for each line on the display. The upper & lower Data knobs on the right of the display are used to alter these parameter's values.

Page 1 looks like so:

Config morph	000
--------------	-----

The higher parameter is "Config morph". In this case with a value of 000.

This parameter morphs the effects configuration from the "Normal" D+R+C configuration to any configuration selected by the Fx config parameter. If this parameter is set to the 00 position the config is "Normal" D+R+C. If this parameter is set to 127 the configuration will be the one selected by the Fx config parameter. In-between this, the configuration is somewhere between the two. This allows many interesting "Cross connections" to occur between the different effects blocks. The range of this parameter is 000 to 127. This parameter is memorised with a Program in Program Mode or memorised with a Program or Performance in Performance Mode depending on the value of the Part's "Part FX" parameter.

Menu - Button & Distort/EQ - Button

When these buttons are pressed a series of pages is available on the display containing parameters relevant to this section.

In the Distort/EQ section there are 8 pages available.

There are a maximum of 2 parameters displayed on any page. One for each line on the display. The upper & lower Data knobs on the right of the display are used to alter these parameter's values.

Page 1 looks like so:

Output level	+20
Gain compensate	+00

The higher parameter is "Output level". In this case with a value of +20.

This parameter determines the output level of the Distortion effect. Use the upper Data knob to adjust this parameter. With a setting of 000 the output is zero & as the Distortion effect is available all the time this can "Mute" the sound. With a setting of 127 the output is maximum. The range of this parameter is 000 to 127. This parameter is memorised with a Program in Program Mode or memorised with a Program or Performance in Performance Mode depending on the value of the Part's "Part FX" parameter.



NOTE:

This parameter can be used as a "Pre Effects level" & so via MIDI control messages can be used to "Gate" the signal pre effects.

EFFECTS SECTION

The lower parameter is "Gain compensate". In this case with a value of +00.

This parameter determines How much Distortion level knob interacts with the Output level parameter. The purpose of this parameter is to make increases or decreases in Distortion level automatically adjust the Output level of the distortion effect so that radical changes in volume can be "Compensated" automatically. Use the lower Data knob to adjust this parameter. With a setting of -64 the Distortion's output level will be reduced with increases of the Distortion level parameter, With a setting of +63 the Distortion will be increased with increases of the Distortion level parameter. The range of this parameter is -64 to +63. This parameter is memorised with a Program in Program Mode or memorised with a Program or Performance in Performance Mode depending on the value of the Part's "Part FX" parameter

Page 2 looks like so:

Distortion curve	+64
Distortion wheel	+00

The higher parameter is "Distortion curve". In this case with a value of +64.

This parameter determines the characteristic of the Distortion effect. Use the upper Data knob to adjust this parameter. With a setting +00 normal clipping type of Distortion occurs. With at +ve value addition symmetrical effects are introduced. With at -ve value addition asymmetrical effects are introduced. The range of this parameter is -64 to +64. This parameter is memorised with a Program in Program Mode or memorised with a Program or Performance in Performance Mode depending on the value of the Part's "Part FX" parameter.

The lower parameter is "Distortion wheel". In this case with a value of +00.

This parameter determines How much the Mod Wheel controls the Distortion effect. Use the lower Data knob to adjust this parameter. With a setting of -64 the Distortion will be reduced with full modulation of the Mod Wheel, With a setting of +63 the Distortion will be increased with full modulation of the Mod Wheel. The range of this parameter is -64 to +63. This parameter is memorised with a Program in Program Mode or memorised with a Program or Performance in Performance Mode depending on the value of the Part's "Part FX" parameter.

Page 3 looks like so:

EQ treble	+20
EQ bass	+64

The higher parameter is "EQ treble". In this case with a value of +20.

This parameter adjusts the Treble of the selected Program. Use the upper Data knob to adjust this parameter. The range of this parameter is -64 to +63. This parameter is memorised with a Program in Program Mode or memorised with a Program or Performance in Performance Mode depending on the value of the Part's "Part FX" parameter.

The lower parameter is "EQ bass". In this case with a value of +64.

This parameter adjusts the Bass of the selected Program. Use the lower Data knob to adjust this parameter. The range of this parameter is -64 to +63. This parameter is memorised with a Program in Program Mode or memorised with a Program or Performance in Performance Mode depending on the value of the Part's "Part FX" parameter..

Page 4 looks like so:

Comb frequency	069
Comb boost	+10

The higher parameter is "Comb frequency". In this case with a value of 069.

This parameter adjusts the Frequency range of the Comb Filter. Use the upper Data knob to adjust this parameter. The range of this parameter is -64 to +63. This parameter is memorised with a Program in Program Mode or memorised with a Program or Performance in Performance Mode depending on the value of the Part's "Part FX" parameter.



NOTE:

No effect will be heard when altering this parameter if the Comb Boost parameter is set to 00

The lower parameter is "Comb boost". In this case with a value of +10.

This parameter adjusts the amount of boost to harmonics the Comb Filter provides. Use the lower Data knob to adjust this parameter. If this parameter is set to the mid position (00) no effect will be heard. If turned Clockwise or anticlockwise from this position boost will be applied to harmonics in the sound. The range of this parameter is -64 to +63. This parameter is memorised with a Program in Program Mode or memorised with a Program or Performance in Performance Mode depending on the value of the Part's "Part FX" parameter.

Page 5 looks like so:

Comb speed	020
Comb depth	064

The higher parameter is "Comb speed". In this case with a value of 020.

This parameter adjusts the speed of the Comb filters modulation LFO. Use the upper Data knob to adjust this parameter. The range of this parameter is 000 to 127. This parameter is memorised with a Program in Program Mode or memorised with a Program or Performance in Performance Mode depending on the value of the Part's "Part FX" parameter.

The lower parameter is "Comb depth". In this case with a value of 064.

This parameter adjusts the depth of the Comb filters LFO modulation. Use the lower Data knob to adjust this parameter. There are in fact 2 Comb filters & when this parameter is +ve both Comb filters are modulated with the Comb LFO at the same phase. i.e. Both going up & down together. When this parameter is -ve both Comb filters are modulated with the Comb LFO in anti phase. i.e. One going up & the other going down. The amount of modulation determines the depth of the Comb effect. The range of this parameter is -63 to +64. This parameter is memorised with a Program in Program Mode or memorised with a Program or Performance in Performance Mode depending on the value of the Part's "Part FX" parameter.

Page 6 looks like so:

Comb spread	-20
-------------	-----

The parameter is "Comb spread". In this case with a value of -20.

There are in fact 2 comb filters. This parameter adjusts the difference in the "Comb frequency" between the two filters. When this parameter is applied the Comb frequencies of the 2 Comb filters are different & more complex Comb filtering results. This is something similar to the "Width" parameter in the Special Filter section. Use the upper Data knob to adjust this parameter. When this parameter is set to 0 both filters are set to the same Comb frequency & they will sound like one comb filter. With +ve settings the Boost to both Comb filters will be whatever was set on page 4 of this menu. When -ve settings are applied the boost to one of the Comb filters will be inverted, creating an even more noticeable stereo effect. The range of this parameter is -64 to +63. This parameter is memorised with a Program in Program Mode or memorised with a Program or Performance in Performance Mode depending on the value of the Part's "Part FX" parameter.

Page 7 looks like so:

Comb freq wheel	+10
Comb boost wheel	+10

EFFECTS SECTION

The higher parameter is "Comb freq wheel". In this case with a value of +10.

This parameter adjusts the modulation of the Comb frequency from the Mod wheel. Use the higher Data knob to adjust this parameter. The range of this parameter is -64 to +63. This parameter is memorised with a Program in Program Mode or memorised with a Program or Performance in Performance Mode depending on the value of the Part's "Part FX" parameter.

The lower parameter is "Comb boost wheel". In this case with a value of +10.

This parameter adjusts the modulation of the Comb boost from the Mod wheel. Use the lower Data knob to adjust this parameter. The range of this parameter is -64 to +63. This parameter is memorised with a Program in Program Mode or memorised with a Program or Performance in Performance Mode depending on the value of the Part's "Part FX" parameter.

Page 8 looks like so:

```
Pass to effects:
                Program only
```

The parameter is "Pass to effects:". In this case with a value of Program only.

This parameter allows the Audio Inputs to be connected into the effects. Use the Lower Fast Data knob to adjust this parameter. If this parameter is set to Program only then the Program only will be connected to the effects chain of the program or Part if in Performance mode. If this parameter is set to Audio input (1) only then the Audio from Input/sw 1 will be will be connected to the effects chain of the Program or Part if in Performance mode & the Program will be disconnected. If this parameter is set to Program & input (1) only then the Audio from Input/sw 1 & the Program will be will be connected to the effects chain of the Program or Part if in Performance mode. Similar values are provided for Audio Input/sw 2. The range of this parameter is Program only, Audio input (1) only, Program & input (1), Audio input (2) only & Program & input (2). This parameter is memorised with a Program in Program Mode or memorised with a Program or Performance in Performance Mode depending on the value of the Part's "Effects Used" parameter.

Menu - Button & Pan - Button

When these buttons are pressed, a series of pages is available on the display containing parameters relevant to this section. In the Pan section there are 2 pages available. These are selected using the page Up & page Down buttons to the left of the display.

Page 1 looks like so:

```
Pan type           Autopan
Pan speed          040
```

The higher parameter is "Pan type" In this case with a value of Autopan.

This parameter determines in what way the panning effects are used. Use the upper Data knob to adjust this parameter. In the Autopan position the Program is "Panned" automatically from Left to Right & back again. In the Tremolo position both Left & Right are controlled in sync creating the classic "Tremolo" effect. Another 2 phases are provided L-R & R-L. these are similar to Autopan but the effect is not symmetrical. The range of this parameter is Autopan, Tremolo L-R & R-L. This parameter is memorised with a Program in Program Mode or memorised with a Program or Performance in Performance Mode depending on the value of the Part's "Part FX" parameter.

The lower parameter is "Pan speed". In this case with a value of 040.

This parameter determines the rate at which the Autopan & Tremolo effects run. Use the lower Data knob to adjust this parameter. The range of this parameter is 000 to 127. This parameter is memorised with a Program in Program Mode or memorised with a Program or Performance in Performance Mode depending on the value of the Part's "Part FX" parameter.

Page 2 looks like so:

Pan depth	080
Dry level	020

The higher parameter is "Pan depth" In this case with a value of 080.

This parameter controls the intensity of the Autopan & Tremolo effects. Use the upper Data knob to adjust this parameter. In the 000 position there is no movement of sound in the stereo field & no change to the programs volume. (No Autopan or Tremolo effects will be heard) As the value of this parameter is increased the Autopan & Tremolo have more & more effect. The range is 000 to 127 Off. This parameter is memorised with a Program in Program Mode or memorised with a Program or Performance in Performance Mode depending on the value of the Part's "Part FX" parameter.

The lower parameter is "Dry level". In this case with a value of 020.

This parameter determines how much "Dry" signal is in the mix. Use the lower Data knob to adjust this parameter. This allows "Pre" effects "Sends" arrangements to be realised. If this parameter is set to 000 no "Dry" sound from the Program will be heard. The sound you will hear will be 100% effect signals. i.e. If the Chorus "Send" is set to 127 & the "Dry level" parameter is set to 000 you will hear only the "Chorused" signal, none of the original. The range of this parameter is 000 to 127. This parameter is memorised with a Program in Program Mode or memorised with a Program or Performance in Performance Mode depending on the value of the Part's "Part FX" parameter.

Menu - Button & Vocoder - Button**NOTE:**

There is only 1 Vocoder in the Nova II keyboard. You cannot have a Performance with several different vocoders on different parts.

When these buttons are pressed, a series of pages is available on the display containing parameters relevant to this section.

In the Pan section there are 4 pages available. These are selected using the page Up & page Down buttons to the left of the display.

Page 1 looks like so:

Sibilance level	15
Sibilance type	Hpass

The higher parameter is "Sibilance level" In this case with a value of 15.

This parameter determines the amount of sibilance there will be in the vocoded signal. Typically these are the "S" type of sounds in speech. Use the upper Data knob to adjust this parameter. If this parameter is set to 00 no sibilance from the modulator's signal will be passed to the output of the vocoder. If this parameter is set to 15 then large amounts of sibilance from the modulator will be passed to the output of the vocoder. The range of this parameter is 00 to 15. This parameter is memorised with a Program in Program Mode or memorised with Performance in Performance Mode.

**NOTE:**

If there is no sibilance in the modulator's signal then this parameter will appear to do nothing.

The lower parameter is "Sibilance type". In this case with a value of Hpass.

This parameter determines if the vocoder uses real sibilance filtered from the modulator or artificially generates it using noise. Use the lower Data knob to adjust this parameter. In the Hpass mode, a High pass filter is used to extract the sibilance from the modulator. In the Noise mode noise is used to artificially generate sibilance. The range of this parameter is Hpass & Noise. This parameter is memorised with a Program in Program Mode or memorised with a Performance in Performance mode.

Page 2 looks like so:

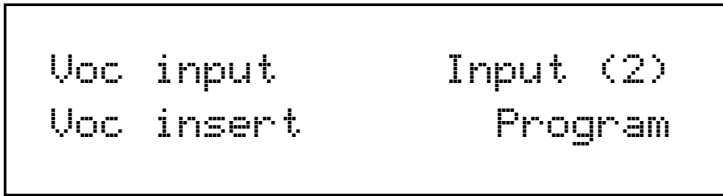

The higher parameter is "Voc input" In this case with a value of Input 2.
This parameter determines what is going to be the "Modulator" of the vocoder. Use the upper Data knob to adjust this parameter. If this parameter is set to Input 1, input 1 will be the modulator. If this parameter is set to Input 2, input 2 will be the modulator. In performance mode, parts 1 to 6 can also be selected. The range of this parameter is Input 1 & input 2 in program mode & Input 1, Input 2 & parts 1 to 6 in performance mode. This parameter is memorised with a Program in Program Mode or memorised with a Program or Performance in Performance Mode .

The lower parameter is "Voc insert". In this case with a value of Program.
This parameter determines what is going to be the "Carrier" for the vocoder. Use the lower Data knob to adjust this parameter. In Program mode, only the currently selected program can be used as the carrier for the vocoder & this parameter shows only the Program option for clarity. In Performance mode, any of the 6 parts can be used as the carrier for the vocoder. The range of this parameter is Program in Program Mode, Part 1 to Part 6 in Performance Mode. This parameter is memorised with a Program in Program Mode or memorised with a Program or Performance in Performance Mode.

Page 3 looks like so:

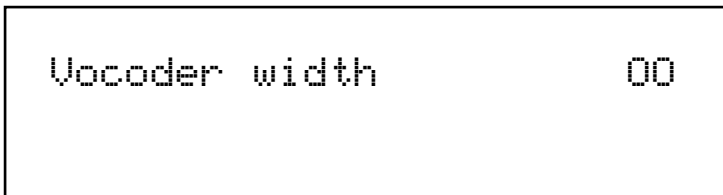

The parameter is "Vocoder width" In this case with a value of 00.
This parameter determines how wide the stereo output of the vocoder will be. Use the upper Data knob to adjust this parameter. If this parameter is set to 00, the output of the vocoder will be Mono. If this parameter is set to 15, the output of the vocoder will be Stereo. The range of this parameter is 00 to 15. This parameter is memorised with a Program in Program Mode or memorised with a Program or Performance in Performance Mode.

Page 4 looks like so:

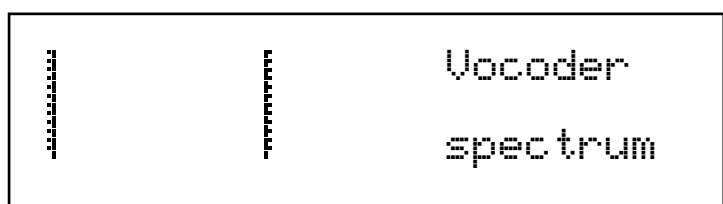

The display is showing "Vocoder spectrum".
On this page the Nova II keyboard displays the Audio spectrum of the modulator in 42 bands on the screen.
This is for display & is not memorised.

Setting up the Inputs for use with the Vocoder.

Set up the Input sensitivity with the "Gain"parameters on page 1 of the Inputs section menu. There are 2 Programs in memory already that have the vocoder function assigned to them already, these are Program D123 Pulse vocoder in 1 & D124 Vocoder in 1. Both of these Programs use the input/sw1 socket as a source for the Modulator.

To set up a Program of your own is straightforward. Select a Program that is going to become the "Carrier" for the Vocoder. The best "Carriers" tend to be bright Pads or similar. In fact Program B127 "Init Prog" is actually quite good for this purpose. In the following example B127 "Init Prog" will be the "Carrier".Select Program mode or Performance mode. If in Program mode select B127. If in Performance mode select the Part to be used for the vocoder, then assign Program B127 to that Part. Press the menu button in the Vocoder section. (the button will flash) Use the page buttons to go to page 2 of this menu & the display will show:

```

Voc input      Input (2)
Voc insert     Program

```

Assign which Input to use as the "Modulator" source using the higher fast data knob. In program mode this will be limited to Input 1 & 2. In Performance mode the options increase to Input 1 & 2, Part 1, 2, 3, 4, 5 & 6. The bottom parameter determines what is going to become the "Carrier". In program mode there is only one choice, the currently selected Program. In Performance mode the options are Part 1, 2, 3, 4, 5 & 6. (Only one part can be assigned at once & only one Vocoder is available at once.)

Now the Vocoder should be working & all that remains is to adjust the Sibilance & width parameters to taste. Also note that the full effects section is available on the selected Part or Program as well. In addition to this in Performance the "Effects used" parameter in the Output menu of the Part edit section allows the use of completely different effects settings from those found in the original Program. (This is in fact almost exactly how the factory Performance A119 is set up.) Once this is done then the Program or Performance can be written into memory.

Bypass - Button

When this button is active (lit) all effects are bypassed & only the dry sound of the synth will be heard.

This parameter is memorised with a Program in Program mode or memorised with a Program or Performance in Performance mode depending on the value of the Part's "Part FX" parameter..

Copy - Button

When this button is pressed, a series of pages is available on the display containing parameters relevant to this section.

In the Reverb section there are 2 pages available. These are selected using the page Up & page Down buttons to the left of the display. The lower Data knob on the right of the display are used to alter these parameter's values.

Page 1 looks like so:

```

Copy program effects
to part effects

```

The parameter is "Copy program effects to part effects".

This is a copying utility that allows copying of the effects settings in the currently selected program to the "Part Effects Buffer". To copy all the Program's effects settings to the Part effects buffer press the Part effects button while in this mode. Selective copying is also possible, that is just one Effects setting can be copied. To copy just the Delay's settings press the Delay menu button while in this mode. To copy just the Reverb's settings press the Reverb menu button while in this mode. To copy just the Chorus settings press the Chorus menu button while in this mode. To copy just the Distortions settings press the Distortion menu button while in this mode. To copy just the Pan's settings press the Pan menu button while in this mode. To copy just the Special's settings press the Special menu button while in this mode. The Vocoder is also an effect & can be copied from a Program to the Performance. (there is only one Vocoder in Performance mode) To copy just the Vocoder's settings press the Vocoder menu button while in this mode. This parameter is not memorised.



NOTE:

It is only possible to copy effects settings in Performance mode.

Page 2 looks like so:

```

Copy part effects
to program effects

```

EFFECTS SECTION

The parameter is "Copy part effects to program effects".

This is a copying utility that allows copying of the effects settings in the currently selected Part effects to the Program.

To copy all the Part's effects settings to the Program press the Part effects button while in this mode. Selective copying is also possible, that is just one Effects setting can be copied. To copy just the Delay's settings press the Delay menu button while in this mode. To copy just the Reverb's settings press the Reverb menu button while in this mode. To copy just the Chorus settings press the Chorus menu button while in this mode. To copy just the Distortions settings press the Distortion menu button while in this mode. To copy just the Pan's settings press the Pan menu button while in this mode. To copy just the Special's settings press the Special menu button while in this mode. The Vocoder is also an effect & can be copied from a Performance to the Program. (there is only one Vocoder in Performance mode) To copy just the Vocoder's settings press the Vocoder menu button while in this mode. This parameter is not memorised.



It is only possible to copy effects settings in Performance mode.

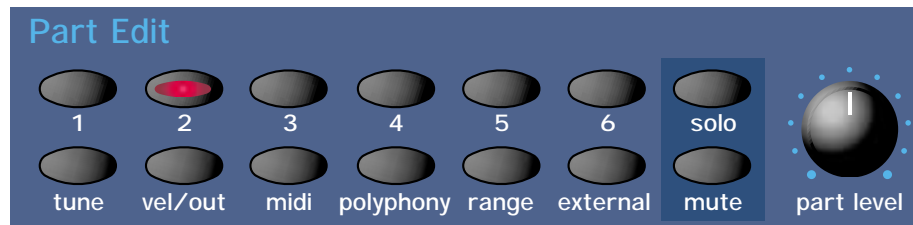

This section contains all the Knobs & buttons associated with the Part Edit Section.

Part 1 - Button

Part 2 - Button

Part 3 - Button

Part 4 - Button

Part 5 - Button

Part 6 - Button



NOTE:

These buttons select "Parts" in Performance Mode. In Program mode they can be used to Audition the currently selected Program. Simply press the Part buttons & a note will play as long as the button is held down. Part 1 button plays C1, Part 2 button plays F1, Part 3 button plays C2, Part 4 button plays F2, Part 5 button plays C3 & Part 6 button plays F3. Additionally in Program mode these buttons light to display the sequence of steps of an Arpeggiator pattern. (If the Arpeggiator is on & playing)

These buttons select which Part of a Performance is going to be edited. Pressing any Part button will assign all the front panel to the Program assigned to the selected Part. To assign a different Program to this Part use the Bank & Prog Up & Down buttons to select a new Program. Moving any knob will bring up the Parameter name on the display in the normal way. To return to the display showing the Part's assigned Program simply press the appropriate Part button again. Any modifications to the Program made in this mode will have to be written into the Program. See writing Performances into memory on page 41 for details.



NOTE:

Part selection can be transmitted & recorded as controller data to a sequencer & the played back to the Nova II keyboard.

Tune - Button



NOTE:

This button only works in Performance mode.

This button alters the Tuning of the Program assigned to the currently selected Part. When this button is pressed the display shows parameters relevant to this section.

When this button is pressed the display shows:

Part semitone	+07
Part detune	+25

The higher parameter is "Part semitone". In this case with a value of +07.

This parameter Transposes the Program by the number of semitones selected using the upper Data knob. The range of this parameter is -24 to +24 semitones. This parameter is memorised with the Performance.

The lower parameter is "Part detune". In this case with a value of +25

This parameter Detunes the Program by the amount selected using the upper Data knob. The range of this parameter is -64 to +63 cents. This parameter is memorised with the Performance.

When this button is pressed in Program mode the display shows:

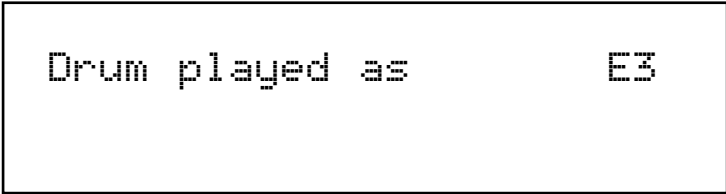

The parameter is "Drum played as" with a value of E3. This parameter determines the note the Drum Program will be pitched at. This is not the note on the keyboard that the Drum Program is triggered from, (this is not assignable) but it is the pitch of the Program. This can be set with the higher Data knob or directly using the keyboard. To do this simply play the desired note on the keyboard while holding down the Page up button when this display is showing & the appropriate note value will automatically be inserted for the currently selected Program. The range of this parameter is C-2 to G8. This parameter is memorised with a Program.



NOTE:

This parameter only takes effect when the program is situated within a Drum Map.

Vel/Out - Button

When this button is pressed a series of pages is available on the display containing parameters relevant to this section. In the In/Out menu there are 3 pages available. These are selected using the page Up & page Down buttons to the left of the display. There are a maximum of 2 parameters displayed. One for each line on the display. The upper & lower Data knobs on the right of the display are used to alter these parameter's values

Page 1 looks like so:

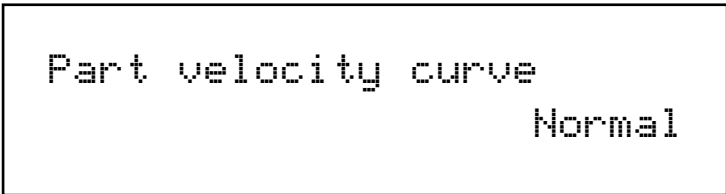

The higher parameter is "Part velocity curve". In this case with a value of Normal. This parameter determines the velocity response of the currently selected Part. Values are selected using the lower Data knob. In the "Normal" position the Program plays in a normal velocity sensitive way. (If the Velocity parameter for the selected Program has been set to any positive value) In the "Inverse" position the response is inverse to the normal velocity curve. i.e. Louder sounds are produced by playing softly rather than hard. (If the Velocity parameter for the selected Program has been set to any positive value) These two curves are ideal for creating velocity Cross fades between to different parts for Organ type sounds. The Cross Fade - Low & Cross Fade - High options are similar but provide a "Normal" overall response when used together in two different parts. The remaining options provide "Normal" velocity curve response "Up to" or "From" specific Velocity values. This enables "Velocity Switch" arrangements to be easily made by setting up appropriate curve on two parts. i.e. To Value 100 on one Part & From Value 101 on another. The range of this parameter is Normal, Inverse, Cross fade - High, Cross Fade - Low, To Value 60, From Value 61, To Value 70, From Value 71, To Value 80, From Value 81, To Value 90, From Value 91, To Value 100, From Value 101, To Value 110 & From Value 111. This parameter is memorised with the Performance.

Page 2 looks like so:

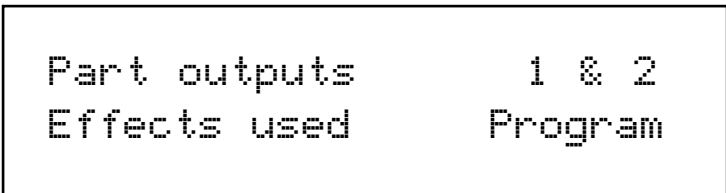

The higher parameter is "Part outputs". In this case with a value of 1and2. This parameter determines which set of outputs the currently selected Part will be output from. Use the upper Data knob to adjust this parameter. It is possible to have each Part go to an individual output. (Mono) To do this set Part 1and 2 to go to outputs 1and2 then pan Part 1 to the Left (output 1) & Part 2 (output 2) to the Right with the panpot. Set Part 3and4 to go to outputs 3and4 then pan Part 3 to the Left (output 3) & Part 4 (output 4) to the Right with the panpot. Set Part 5and6 to go to outputs 5and6 then pan Part 5 to the Left (output 5) & Part 6 (output 6)

to the Right with the panpot. The range of this parameter is 1and2, 3and4, 5and6 & 7and8. This parameter is memorised with the Performance.



NOTE:

If the Delay, Reverb or Rotary Speaker/Ensemble/Chorus/Flanger/Phaser effects are used they will produce stereo signals over an output pair. To isolate a sound to a single mono output, it is necessary to make sure the send levels of these effects are set to 000.

The lower parameter is "Effects used". In this case with a value of Program.

This parameter determines if the Effects buffer used for the currently selected Part is the assigned Program's or the Parts "Override" buffer. Use the lower Data knob to adjust this parameter. When this is set to Part all effects settings are in the Part FX buffer & do not use the settings of the effects in the source Program assigned to the currently selected Part. When this button is set to Program all effects settings are derived from the source Program assigned to the currently selected Part. Additionally this parameter determines if the Effects to be used by the Part will change when a MIDI Program Change message is received from the current settings to the settings of the new Program or not. This can be useful for dramatic changes in Effects by setting this parameter to Program, or this parameter can be useful for retaining the effects used on this Part when a MIDI Program Change is received by setting it to "Part". This parameter is memorised with the Performance.

Page 3 looks like so:

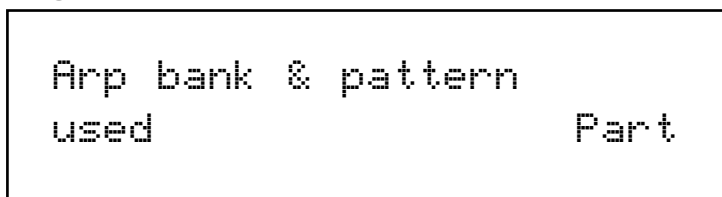

The parameter is "Arp bank & pattern used" & is currently set to Part.

This parameter determines if the Arpeggiator Pattern assigned to the Program which is assigned to the currently selected Part is used or is overridden. This can be useful if you want to assign a different pattern to that that was set in the Program & means that it is not necessary to make a copy of the same Program with a different Arpeggiator Pattern assigned. Use the higher Data knob to adjust this parameter. The range of this parameter is Part & Program. This parameter is memorised with a Performance.



NOTE:

When this parameter is altered, the Pattern Bank & Pattern number parameters on page 2 of the Arpeggiator menu will display the Pattern Bank & Pattern number stored in the Program when this parameter is set to Program, or the Pattern Bank & Pattern number stored in the Performance when this parameter is set to Part.

MIDI - Button

This button only works in Performance mode.

When this button is pressed a series of pages is available on the display containing parameters relevant to this section.

In the MIDI menu there are 5 pages available. These are selected using the page Up & page Down buttons to the left of the display.

There are a maximum of 2 parameters displayed. One for each line on the display. The upper & lower Data knobs on the right of the display are used to alter these parameter's values.



NOTE:

If you are currently on the Sysex transmission page of the Global menu, Pressing this button will initiate a sysex dump.

Page 1 looks like so:

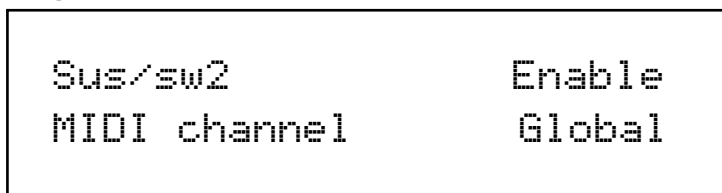

The higher parameter is "Sus/sw2". In this case with a value of Enable.

This parameter determines how the selected Part will respond to incoming MIDI/Sustain pedal data. (Controller 64). This parame-

PART EDIT SECTION

ter is adjusted using the upper Data knob. If this parameter is set to "Enable" the Envelopes are held at their sustain phases if a MIDI Sustain pedal message of "On" is received. (This is similar to the Damper pedal on a Piano) . The Sustain pedal message can be set to do other things as well though. If this parameter is set to "Arp Latch" the Arp latch function will be switched on when a Sustain pedal message of "On" is received & switched "Off" when a pedal "off" is received. Similarly if this parameter is set to "Arp Mute" or "Part Mute" the respective mute function will be controlled in the same way. Some manufacturers have different polarity pedals which can make this parameter behave in reverse so inverse parameters have been added as an option. Additionally it is often useful when layering 2 or more Parts to have one Part enabled & the other(s) disabled so an "Off" option is available. The range of this parameter is Enable, Arp Latch, Arp Mute, Part Mute, Enable (I), Arp Latch (I), Arp Mute (I), Part Mute (I) & Off. This parameter is memorised with the Performance.

The lower parameter is "MIDI channel". In this case with a value of Global.

This parameter selects the MIDI Channel the Part will receive & transmit MIDI Data on. Use the lower Data knob to adjust this parameter. If this parameter is set to "Global" the Part will play on whatever channel is set as the "Global MIDI channel" on page 1 of the Global menu. If this parameter is set to "Omni" the Part will play on any MIDI channel. The range of this parameter is 1 to 16 Omni & Global. This parameter is memorised with the Performance.



NOTE:

The MIDI channel for the Part can be set via MIDI by holding down the Page down button & while holding it down playing a note into the Nova II keyboard on the desired channel. It is not possible to set the Part's MIDI channel to Omni or Global using this method.

Page 2 looks like so:

Sw1	Off
Sw3	Off

These parameters determine how the currently selected Part will respond to the type of MIDI controller data which is generated when footswitches 1 or 3 are pressed. This MIDI controller data could arrive either by a sequencer or be directly generated by the footswitches (provided the relevant footswitch is enabled for this Part, see page 4 of the MIDI Menu). Use the upper Data knob to adjust Switch 1 & the lower Data knob to adjust Switch 3. The range of this parameter is Off, Sustain, Arp latch, Arp mute, Part mute, Sustain (I), Arp latch (I) Arp mute (I) & Part mute (I). These parameters are memorised with a Performance.



NOTE:

The "Sw3" parameter on this page only applies to the type of MIDI controller data generated when Footswitch 3 is configured to "Switch" or "Switch-I" on page 10 of the Global Menu.

Page 3 looks like so:

Pedal/breath	Off
--------------	-----

This parameter determines whether the currently selected Part will respond to the type of MIDI controller data which is generated when footswitch 3 is pressed when it is acting in "Pedal" mode (it is configured to "Pedal-R" or "Pedal-T" on page 10 of the Global Menu). This MIDI controller data could arrive either by a sequencer or be directly generated by footswitch 3 (provided footswitch 3 is enabled for this Part on page 4 of the MIDI Menu).

When footswitch 3 is configured for use as a pedal (rather than a footswitch), it generates data using controller CC002 (also known as breath control). This in turn can be re-mapped to any other controller or aftertouch, pitch bend etc. by altering the "Pedal/breath" re-mapping parameter on page 4 of the Global menu. Therefore, many types of dynamic modulation are possible using the pedal - volume, filter cutoff frequency etc. The range of this parameter is Off & On. This parameter is memorised with a Performance.

Page 4 looks like so:

123	Switch 1
X	Disabled

These parameters determine the various switch functions are active or not. Turning the higher fast data knob selects the Switch to be edited. The Display shows the selected Switch on the top right of the display & its status is indicated on the bottom left of the display, in this case X. The range of this parameter is Switch 1, Switch 2 & Pedal Switch 3. The lower parameter sets the status, X equals Disabled & O equals Enabled. When set to Disabled, Footswitch operation have no affect on the Part plus no MIDI for the Footswitch is transmitted for this Part. When set to Enabled, Footswitch operation affects the Part plus MIDI is transmitted for the Footswitch on this Part. This parameter is memorised with a Performance.

Page 5 looks like so:

Prog change	filt	Off
Controller	filt	Off

The higher parameter is "Prog change filt". In this case with a value of Off.

This parameter determines how the selected Part will respond to incoming Program Change messages. This parameter is adjusted using the upper Data knob. If this parameter is set to "On" the Part will ignore any Program Change messages sent on the Part's MIDI channel. If this parameter is set to "Off" the Part will recognise any Program Change messages sent on the Part's MIDI channel. The range of this parameter is On & Off. This parameter is memorised with the Performance.



NOTE:

If the Global Program Change filter on page 12 of the Global menu is set to Disabled, then no Program Change messages will be recognised regardless of this parameters setting.



NOTE:

If the Program Change filter is set to On it also filters out Bank select messages. (CC00 & CC32)

The lower parameter is "Controller filt". In this case with a value of Off.

This parameter determines how the selected Part will respond to incoming Controller messages. This parameter is adjusted using the lower Data knob. If this parameter is set to "On", the Part will ignore any Controller messages sent on the Part's MIDI channel. If this parameter is set to "Off", the Part will recognise any Controller messages sent on the Part's MIDI channel. The range of this parameter is On & Off. This parameter is memorised with the Performance.



NOTE:

If the Global Control Change filter on page 12 of the Global menu is set to Disabled, then no Control Change messages will be recognised regardless of this parameters setting.



NOTE:

The Control Change filter does not filter Bank select messages. (CC00 and CC32) These can be filtered using the Program Change filter if required.

Polyphony - Button

This button works in Performance & Program mode.

This button alters the Polyphony of the currently selected Program or Part. When this button is pressed, the display shows parameters relevant to this section. There are a maximum of 2 parameters displayed. One for each line on the display. The upper & lower Data knobs on the right of the display are used to alter these parameter's values.

When this button is pressed the display shows:

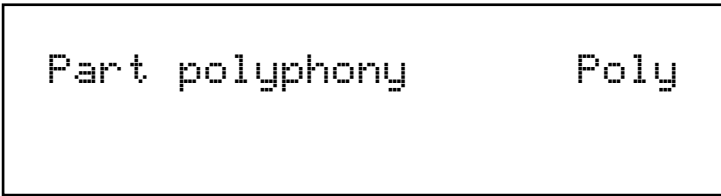

The higher parameter is "Part polyphony". In this case with a value of Poly. This parameter assigns how much polyphony is assigned to the selected Part & is adjusted using the upper Data knob. If this is set to Off (Performance mode only) the Part is disabled. No sound will come from this Part & it will not respond to MIDI. If this parameter is set to Mono, only one voice is assigned to the Part. (Monophonic). If this is set to Poly, voices are dynamically allocated to the Part. All voices will be dynamically shared by the Parts. If this parameter is set to Prog, the Polyphony setting of the currently selected Program in the currently selected Part is mirrored by the Part. i.e. If a Monophonic Program was selected in the Part then the Part's polyphony would be Monophonic & if a Polyphonic sound was selected then the polyphony would automatically change to Polyphonic. In Program mode, the display is different. It shows "Program Mode" on the top line of the display & "Polyphony" on the bottom line.

When this button is pressed when in Program mode the display shows:

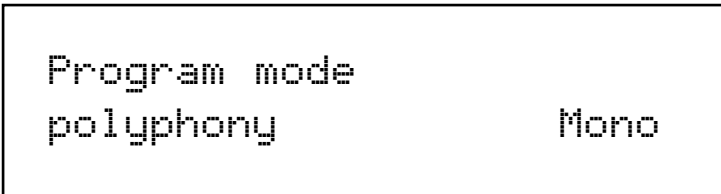

When in Program mode, the display is different but the function is the same. Use the lower Data knob to adjust this parameter. The range of this parameter in the Performance mode is Off, Poly , Mono. & Prog. In the Program mode the range is Poly & Mono. This parameter is memorised with Programs in Program Mode & Performances in Performance Mode.

Range - Button

This button only works in Performance mode. This button alters the Key Range of the currently selected Part. When this button is pressed, the display shows parameters relevant to this section. There are a maximum of 2 parameters displayed. One for each line on the display. The upper & lower Data knobs on the right of the display are used to alter these parameter's values.

When this button is pressed the display shows:

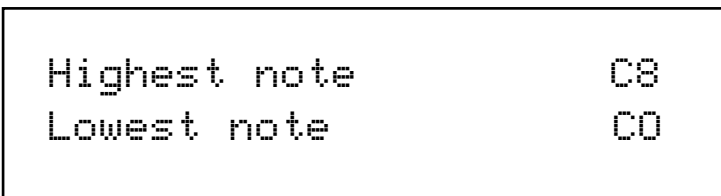

The higher parameter is "Highest note". In this case with a value of C8. This parameter selects the Highest note the currently selected Part will play on & is adjusted using the upper Data knob. The range of this parameter is C-2 to G8 . This parameter is memorised with the Performance.

The lower parameter is "Lowest note". In this case with a value of C0. This parameter selects the Lowest note the currently selected Part will play on & is adjusted using the lower Data knob. The range of this parameter is C-2 to G8 . This parameter is memorised with the Performance.



NOTE:

If the Lowest note is set higher than the Highest note, a reverse window can be created. For example: If Part Highest key is set to C2 & Part lowest key is set to C3. The sound appears on the keyboard from C0 to C2 & from C3 to C8. In other words there is a "Hole" in the middle of the keyboard.



NOTE:

The Range for the Part can be set via the keyboard by holding down the Page up (for the Highest note) or Page down (for the Lowest note) buttons & while holding down, playing a note on the Nova II keyboard at the desired split point. You can set both parameters simultaneously by holding down both page buttons.

External - Button

This button only works in Performance mode.

This button allows access to all the parameters that deal with the Master keyboard functions of the Nova II keyboard. This button works slightly differently from the others in the Part Edit section. It's operation is similar to a shift function on a qwerty keyboard. When this button is used in conjunction with other buttons in the Part Edit section different pages appear that contain parameters relating to the Master Keyboard functions. i.e. When the External & MIDI buttons are lit the display shows all the External MIDI pages. When this button & another of the Part Edit sections buttons is pressed, the display shows parameters relevant to this section. There are a maximum of 2 parameters displayed. One for each line on the display. The upper & lower Data knobs on the right of the display are used to alter these parameter's values.

A brief outline of the Master Keyboard Functions.

There are always 6 internal parts available via MIDI in the Nova II keyboard. There are up to 6 different external modules that can also be controlled via MIDI. The keyboard can control external modules exclusively, internal Parts exclusively or both simultaneously.

At all times, all 6 internal Parts may be controlled via MIDI. If the External button in Part edit section is unlit, the keyboard will play the currently selected internal Part(s) plus any external Part(s) which have the External Part MIDI parameter set to anything but Off. In this case, the keyboard will always transmit note messages corresponding to the currently selected internal Parts MIDI channel setting. If the External button in the Part edit section is lit, The keyboard will not play internal Parts. (internal can still be played via MIDI on the appropriate MIDI channels) In this case, the keyboard will transmit on external Parts if the External Parts MIDI parameter set to anything but Off.

If the External button in the Part edit section is lit, the Part edit buttons flash to indicate which External Parts are transmitting MIDI data rather than indicating which internal Parts are being triggered. The status of the external button is saved with a Performance.

The following functions for each external "Part" (External MIDI channel) can be controlled using the Nova II keyboards Master Keyboard functions.

External Semitone Transposition - Accessed using the External & Tune Buttons.

(used for playing external modules in a different key)

External Velocity Zone - Accessed using the External & Tune Buttons.

(used for playing external modules within a specific velocity window, this could be thought of as an external velocity switch)

External On/Off - Accessed using the External & MIDI Buttons.

External MIDI Channel - Accessed using the External & MIDI Buttons.

External Program Change Message Enable/Disable - Accessed using the External & MIDI Buttons.

External Program Change Message - Accessed using the External & MIDI Buttons.

External Bank Change Message Enable/Disable - Accessed using the External & MIDI Buttons.

External Bank Change Message MSB & LSB - Accessed using the External & MIDI Buttons.

External Mod wheel Enable/Disable - Accessed using the External & MIDI Buttons.

External Mod wheel Controller Assignment - Accessed using the External & MIDI Buttons.

External Pitch Bend wheel Enable/Disable - Accessed using the External & MIDI Buttons.

External Aftertouch Enable/Disable - Accessed using the External & MIDI Buttons.

External Volume Enable/Disable - Accessed using the External & MIDI Buttons.

External Volume - Accessed using the External & MIDI Buttons.

External Sustain Pedal Enable/Disable - Accessed using the External & MIDI Buttons.

(Full MIDI control of up to 6 independent external MIDI modules/keyboards)

External Key window - Accessed using the External & Range Buttons.

(used for playing external modules within a specific key window, this could be thought of as an external split point)

External - Button & Tune - Button (both lit)

When these buttons are pressed the display shows:

Ext part semitone transpose	+00
--------------------------------	-----

The parameter is "External part semitone transpose". In this case with a value of +00. This parameter determines the possible transposition (or not) of the MIDI note data being transmitted by the selected external "Part". This parameter is adjusted using the lower Data knob. If this parameter is set to +00 as shown the note data transmitted for the selected external part will be exactly the same as the notes played on the keyboard. A setting of +7 will result in the MIDI note data for the selected external Part being transposed up 7 seven semi tones. Similarly negative values result in negative transpositions of transmitted note data. The range of this parameter is -60 to +60 semitones. This parameter is memorised with the Performance.



NOTE:

The External Part MIDI ch parameter (in the External & MIDI buttons menu) has to be set to any MIDI channel (not set to Off) for the selected external Part for any External MIDI data to be transmitted.

External - Button & Velocity - Button (both lit)

When these buttons are pressed the display shows:

Ext velocity max	127
Ext velocity min	127

The higher parameter is "External velocity max". In this case with a value of 127. This parameter in conjunction with the "External velocity min" parameter determines the velocity range of the MIDI note on data being transmitted by the selected external "Part". This parameter is adjusted using the higher Data knob. This parameter determines the highest keyboard velocity at which any MIDI note data will be transmitted on the selected External Part. The range of this parameter is 000 to 127. This parameter is memorised with the Performance.



NOTE:

It is not possible to set the Velocity max below the Velocity min value or Velocity min above the Velocity max value.



NOTE:

These parameters can be set using the keyboard. Pressing & holding down the Page up button when playing a note sets the Velocity max value. Pressing & holding down the Page down button when playing a note sets the Velocity mix value.



NOTE:

The External Part MIDI ch parameter (in the External & MIDI buttons menu) has to be set to any MIDI channel (not set to Off) for the selected external Part for any External MIDI data to be transmitted.

The lower parameter is "External velocity min". In this case with a value of 000. This parameter in conjunction with the "External velocity max" parameter determines the velocity range of the MIDI note on data being transmitted by the selected external "Part". This parameter is adjusted using the lower Data knob. This parameter determines the lowest keyboard velocity at which any MIDI note data will be transmitted on the selected External Part. The range of this parameter is 000 to 127. This parameter is memorised with the Performance.



NOTE:

It is not possible to set the Velocity max below the Velocity min value or Velocity min above the Velocity max value.



These parameters can be set using the keyboard. Pressing & holding down the Page up button when playing a note sets the Velocity max value. Pressing & holding down the Page down button when playing a note sets the Velocity mix value.



The External Part MIDI ch parameter (in the External & MIDI buttons menu) has to be set to any MIDI channel (not set to Off) for the selected external Part for any External MIDI data to be transmitted.

External - Button & MIDI - Button (both lit)

Page 1 looks like so:

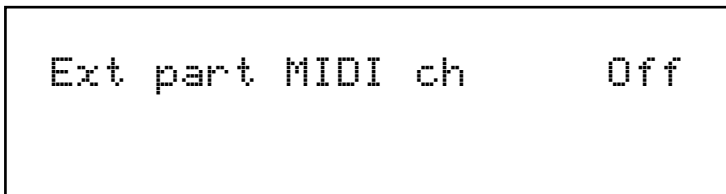

The parameter is "External part MIDI channel". In this case with a value of Off. This parameter determines if the external MIDI functions are enabled or not & the MIDI channel of the data being transmitted by the selected external "Part". This parameter is adjusted using the higher Data knob. If this parameter is set to Off as shown, no MIDI data will be transmitted for this External Part. If however any MIDI channel is assigned to the selected external Part then the Master keyboard functions are activated for that Part. The range of this parameter is Off, 1 to 16. This parameter is memorised with the Performance.



The External Part MIDI ch parameter (in the External & MIDI buttons menu) has to be set to any MIDI channel (not set to Off) for the selected external Part for any External MIDI data to be transmitted.

Page 2 looks like so:

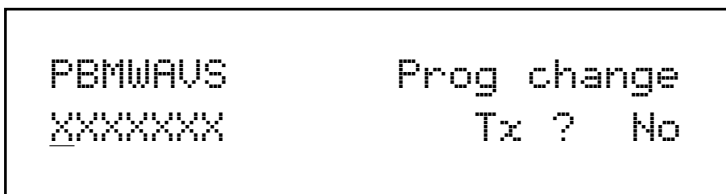

The higher parameter is "PBMWAVS". In this case with a value of Prog change. These parameters determine if the currently selected external Part will transmit various different types of MIDI data. Use the upper Data knob to select the type of data to be transmitted. The range of this parameter is Prog change, Bank change, Mod wheel, Pitch bend, Aftertouch, Volume & Sustain & the current selection is indicated on the top right of the display. On the bottom row of the display an X or a O indicates if the current selected option is transmitted or not & confirmation is displayed on the bottom right of the display as Yes or No. This parameter is memorised with the Performance.



The External Part MIDI ch parameter (in the External & MIDI buttons menu) has to be set to any MIDI channel (not set to Off) for the selected external Part for any MIDI data to be transmitted.

Page 3 looks like so:

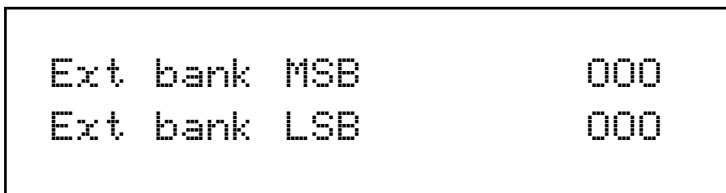

The higher parameter is "External bank MSB". In this case with a value of 000.

The Lower parameter is "External bank LSB". In this case with a value of 000.

These parameters in conjunction with the "PBMWAVS" parameter on page 2 of this menu determines the External MIDI Bank messages to be sent for the currently selected external part when the current Performance is selected. The range of these parameters is 000 to 127. This parameter is memorised with the Performance.



The External Part MIDI ch parameter (in the External & MIDI buttons menu) has to be set to any MIDI channel (not set to Off) for the selected external Part for any External MIDI data to be transmitted.

Page 4 looks like so:

Ext program no.	000
Ext volume level	127

The higher parameter is "External program number". In this case with a value of 000.

This parameter in conjunction with the "PBMWAVS" parameter on page 2 of this menu determines the External MIDI program change message to be sent for the currently selected external part when the current Performance is selected. The range of these parameters is 000 to 127. This parameter is memorised with the Performance.



The External Part MIDI ch parameter (in the External & MIDI buttons menu) has to be set to any MIDI channel (not set to Off) for the selected external Part for any External MIDI data to be transmitted.

The lower parameter is "External volume level". In this case with a value of 000.

This parameter in conjunction with the "PBMWAVS" parameter on page 2 of this menu determines the External MIDI volume to be sent for the currently selected external part when the current Performance is selected. The range of these parameters is 000 to 127. This parameter is memorised with the Performance.



The External Part MIDI ch parameter (in the External & MIDI buttons menu) has to be set to any MIDI channel (not set to Off) for the selected external Part for any External MIDI data to be transmitted.

Page 5 looks like so:

Mod wheel Tx	CC000
--------------	-------

The parameter is "Mod wheel Tx". In this case with a value of CC000.

These parameters in conjunction with the "PBMWAVS" parameter on page 2 of this menu determines the External MIDI Controller to be sent for the currently selected external part when the Mod wheel is turned when the current Performance is selected. This allows the Mod wheel to control any Controller externally. The range of these parameters is CC000 to CC127. This parameter is memorised with the Performance.



To transmit normal Mod wheel messages make sure this parameter is set to CC001.



The External Part MIDI ch parameter (in the External & MIDI buttons menu) has to be set to any MIDI channel (not set to Off) for

the selected external Part for any External MIDI data to be transmitted.

Page 6 looks like so:

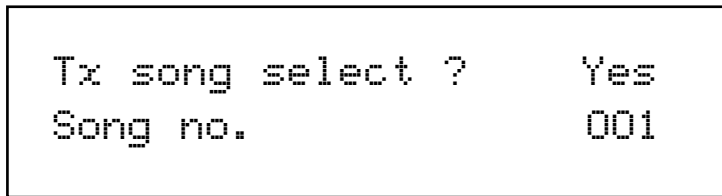

The parameter is "TX song select?". In this case with a value of Yes.

This parameter determines if the Nova II keyboard transmits a MIDI song select message when a new Performance is selected. Use the higher Data knob to adjust this parameter. When this parameter is set to Yes the Song number specified in the "Song no." parameter below is transmitted when the current Performance is selected. If this parameter is set to Off then no Song number message is transmitted. The range of this parameters is Yes & No. This parameter is memorised with the Performance.



NOTE:

This parameter cannot be set separately for each Part & is "Global" for the selected Performance.



NOTE:

The Song select message this parameter can generate is not MIDI channelised so the setting of the Parts MIDI channel parameter is irrelevant.

The parameter is "Song no.". In this case with a value of CC000.

If the TX song select ? parameter above is set to Yes then the Song number specified here will be sent as a Song select message when the current Performance is selected. The range of these parameters is 000 to 127. This parameter is memorised with the Performance.

External - Button & Range - Button (both lit)

When these buttons are pressed the display shows:

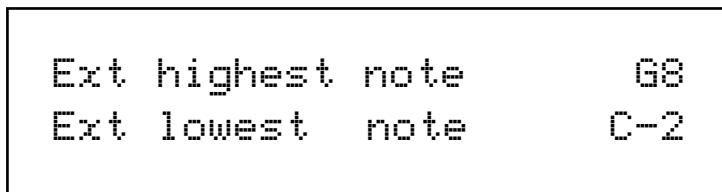

The higher parameter is "External highest note". In this case with a value of G8.

This parameter in conjunction with the "External lowest note" parameter determines the keyboard range of the MIDI note data being transmitted by the selected external Part. This parameter is adjusted using the higher Data knob. This parameter determines the highest key at which any MIDI note data will be transmitted on the selected External Part. The range of this parameter is C-2 to G8. This parameter is memorised with the Performance.



NOTE:

The External Part MIDI ch parameter (in the External & MIDI buttons menu) has to be set to any MIDI channel (not set to Off) for the selected external Part for any External MIDI data to be transmitted.

The lower parameter is "External lowest note". In this case with a value of C-2.

This parameter in conjunction with the "External highest note" parameter determines the keyboard range of the MIDI note data being transmitted by the selected external Part. This parameter is adjusted using the lower Data knob. This parameter determines the lowest key at which any MIDI note data will be transmitted on the selected External Part. The range of this parameter is C-2 to G8. This parameter is memorised with the Performance.



NOTE:

The External Part MIDI ch parameter (in the External & MIDI buttons menu) has to be set to any MIDI channel (not set to Off) for the selected external Part for any External MIDI data to be transmitted.

No Power.

Power Supply not connected properly. If applicable, check fuse in mains plug.

No Sound.

Check the "Volume" knob is not set at zero. Check that the correct MIDI receive Channel is selected. Check that all mixer parameters are not set to zero. Check that a Volume MIDI Message of zero is not being transmitted to Nova II keyboard. Check that the Filter Frequency knob or Sustain & Decay knobs of Env1 are not set to zero. Check that Local On/Off in Global Mode is not set to Off. Check Arp Mute is not active. (lit) Check Part Polyphony is not set to Off. Check Pass to Effects parameter in Dist/EQ/Config menu is not set to Input 1 or 2 but program. Check that the Arpeggio notes to: parameter in Arp Menu is not set to MIDI only. Check Part levels in a Performance are not set to 0.

LFOs, Delays and/or Arpeggiator do not sync to MIDI Clock.

Check the Clock parameter in the Global Mode is set to Ext. (refer page 50) If this is set to external, check the Nova II keyboard is synced by varying the tempo of the Sequencer. If the Nova II keyboard speeds up & slows down accordingly, Nova II keyboard is synced to MIDI Clock. However it is possible to synchronise the LFOs, Delay & Arpeggiator to many different time signatures. This can lead to a situation where the Nova II keyboard may be synced but synchronised at a strange time signature. Check the synchronisation parameters refer on page 92 for the LFOs, page 106 for the Delay & page 65 for the Arpeggiator for details.

LFOs, Delay and/or Arpeggiator is stuck/stopped/does not work.

This is almost certainly because the LFOs, Delay and/or Arpeggiator are set to sync to MIDI Clock. To check this see if the Clock parameter in the Global Mode is set to Ext. (refer page 50) If it is set to External then setting this parameter to internal will restore the operation of the LFOs, Delay & or Arpeggiator. If you wish these to be synced to MIDI Clock, leave this parameter in External & confirm that the sequencer is actually sending MIDI Clock. A lot of software sequencers default to NOT transmitting MIDI Clock. If the LFO / Delay / Arp is stuck / not functioning & you have the Clock parameter in the Global Mode is set to Ext, the sequencer is not sending MIDI Clock. There is no other reason.

Cannot record knob movements on the sequencer.

Some sequencers / software feature a "filter" for filtering out unwanted data. Controllers is usually an option. This data must not be filtered out by the program. Consult the sequencer / software's owners manual for details.

Cannot change "Banks" via MIDI.

Bank changes are different from program changes & are actually two messages. For this reason, some sequencers / software have a "Bank Box" or similar in an attempt to simplify things. However sometimes on early versions of software this function may not be available. If this is the case & your sequencer does not have a "Bank Box" or similar you will have to enter in the data manually in a "List Edit" or similar function within the sequencer. You will have to enter a controller with specific values & then a program change message, all with the right values & in the right order & on the right channels. If the message you send does not change the bank on the Nova II keyboard then you are not sending the right messages & values. Consult your sequencer / software owners manual for details. Bank change messages are as follows. They must be sent as shown & in the correct order. A Program Bank "A" message is as follows: enter a controller 32 message with a value of 5 followed by a program change message with the value of the program you want. i.e. for program 6 enter 7. A Program Bank "B" message is as follows: enter a controller 32 with a value of 6 followed by a program change message with the value of the program you want. Alternatively simply select the desired Performance / Program from the Nova II keyboard's front panel while recording into a sequencer. Make sure the MIDI output of the Nova II keyboard is connected to the MIDI input of your sequencer / computer either directly or via a merge box.



There is a Table of Bank messages recognised by the Nova II keyboard on page 137.

Nova II keyboard does not respond to Program Change / Bank select messages.

Check that the Incoming Program change parameter in the Global mode is set to Enabled and/or the Prog change filt parameter in MIDI menu of the Part edit section is not On.

Nova II keyboard does not respond to Controller messages.

Check that the Incoming control change parameter in the Global mode is set to Enabled and/or the Controller filter parameter in MIDI menu of the Part edit section is not On.

The knobs & buttons do not alter the sound / do anything.

Check that the Local On/Off parameter in Global mode is not set to Off.

Cannot receive Sysex dumps (Progs-Perfs)

Check that Memory Protect is set to Off & Sysex reception is set to Normal (RX as sent). If you are sending C or D Bank Perfs or E,F,G or H Bank Progs from an Expanded Nova II keyboard (Nova II keyboard Pro) to a standard Nova II keyboard, then these sounds will not go into the Nova II keyboard as corresponding banks do not exist in the standard machine. You can however specify All Progs to bank A, B, C or D & All Perfs to bank A or B to get around this.

The Nova II keyboard switches itself from Perf mode to Prog mode.

This is because the MIDI out & MIDI in of the Nova II keyboard is connected to a sequencer which is remapping Bank/Program messages (generated by changing Program/Bank on a Part) to a channel corresponding to the Global channel of the Nova II keyboard. The solution is to Filter out Bank messages in the Sequencer, or disconnect the midi out of the Nova II keyboard, or disable the "Thru" function on the sequencer, or to change the Global channel of the Nova II keyboard to one not being used in the sequencer.

When editing a Part in Perf mode, other parts are being edited as well.

This is because the MIDI out & MIDI in of the Nova II keyboard is connected to a sequencer which is remapping controller messages (generated by editing parameters on a Part) to a channel corresponding to the channel of the other Part. The solution is to switch the local control parameter in global to off. This means all edits will be carried out via the MIDI chain rather than directly & the sequencer will dictate which part is being edited by the MIDI channel setting on the track. The alternatives are not very friendly, they are to filter out controller messages in the Sequencer, or disconnect the midi out of the Nova II keyboard, or disable the "Thru" function on the sequencer.

Upgrading the sounds in the Nova II keyboard

New sound banks are available on our Web site (<http://www.novationuk.com> or <http://www.novationusa.com>) & are free to download. This is actually very similar to upgrading the OS in your supernova.

- 1 - Connect the MIDI out of the sequencer to the MIDI in of the Nova II keyboard.
- 2 - Turn the Memory Protect OFF (in page 7 of the Global mode) & make sure your Nova II keyboard is set to global channel 1. (page 1 of the Global mode)
- 3 - Load the Total.mid file into your sequencer.
- 4 - Play the sequencer. (The display will show the status of incoming messages)



NOTE:

If you experience problems with this file, it is probably due to similar problems that can occur when updating the OS. Please Refer to page 134 "Problems that can occur when updating an OS & sounds".

Upgrading the Operating System in the Nova II keyboard

On our Web Site (<http://www.novationuk.com> or <http://www.novationusa.com>) the latest Operating System Software is available free to download. Please follow the instructions below for details on how to upgrade you Nova II keyboard's Operating System.

- 1 - **BACK UP YOUR DATA.**
Make a backup of your data to computer. By this I mean everything. Use the "Total data" setting in the Sysex transmission parameter in global mode.
- 2 - **VERIFY YOUR BACKUP.**
Change the name of one of the sounds & write the change in. Then reload your sounds from YOUR BACKUP that you have just made. If the name has changed back to what it was when you made the backup. Chances are the backup is OK.
- 3 - **SWITCH THE NOVA II KEYBOARD OFF.**
- 4 - **CONNECT MIDI OUT OF THE SEQUENCER TO MIDI IN ON THE NOVA II KEYBOARD.**
- 5 - **LOAD THE SNVnn.mid FILE INTO YOUR SEQUENCER.**

TROUBLESHOOTING

6 - HOLD DOWN PART BUTTON 8 and SWITCH THE NOVA II KEYBOARD ON WHILE STILL HOLDING IT DOWN.

The display should show:

```
Waiting for midi O/S
```

7 - PLAY THE SEQUENCER.

If everything is OK you'll get a display like so indicating the amount of file received.

```
Receiving OS 1.nn  
progress...10%
```

Once the file has reached 100% the display will show:

```
OK - updating flash  
progress...10%
```

The Nova II keyboard is now updating the OS in Flash Memory.



NOTE:

Under no circumstances switch off the Nova II keyboard while this procedure is happening. Doing so may result in very erratic behaviour & may lead to the Nova II keyboard needing to be sent back for service!

Once the Flash has been loaded the Nova II keyboard will automatically reboot as normal running the new OS.

Problems that can occur when updating an OS & sounds.

While we have taken every precaution in designing the OS to be upgraded trouble free, sometimes problems can occur. This is not solely down to us but in almost all cases rests with the sequencer/hardware used to perform the upgrade.

If an error occurs during the upgrade process the display will show:

```
Packet error!!  
Switch off and re-try
```

This is an indication that a error has occurred in the download process that does not make any sense to the Nova II keyboard.



NOTE:

This is not caused by the Nova II keyboard but by the transmitting device. This is caused by the software or the hardware used to transmit the OS to the Nova II keyboard. Do what it says, switch the Nova II keyboard off & re-try.

If the problem re-occurs, then please look below.

PC's

PC's have the most problems. As said above this is not a fault in the Nova II keyboard but the transmitting device. In these devices it seems to be a compound problem with hardware & software. Some applications will work with some MIDI interfaces & not with others.

Solution 1 is try another sequencer / application.

Solution 2 is try another MIDI interface.

Solution 3 is try another sequencer / application with a different MIDI interface.

Cubase works most of the time depending on the version & interface.

Cakewalk works sometimes depending on the version & interface.

Logic works most of the time depending on the version & interface.

Media Player works sometimes depending on the version & interface.

Freelader works most of the time depending on the version & interface.

Some USB MIDI interfaces do seem to have problems handling this data. Please contact the manufacturer to get the latest Drivers / Operating systems for the interfaces. At the point of writing no USB interface known can reliably do this.

If none of this works...Try a different computer. Feel free to ask the sequencer manufacturer why large sysex files as .mid files are incompatible with their application. (.mid files are meant to be an international standard)

Macintosh

Mac's seem to be relatively trouble free. I have encountered some problems with older ones though. The same solutions apply.

Solution 1 is try another sequencer/application.

Solution 2 is try another MIDI interface.

Solution 3 is try another sequencer / application with a different MIDI interface.

Some USB MIDI interfaces do seem to have problems handling this data. Please contact the manufacturer to get the latest Drivers / Operating systems for the interfaces. At the point of writing no USB interface known can reliably do this.

If none of this works...Try a different computer. However this is rarely necessary.

ATARI

Never had a problem ever, an 8meg 16 bit machine can cream the lot of em.

AMIGA

Bars & Pipes Pro works but it could be down to the interface.

WORKSTATIONS

Workstations such as KORG's Trinity/X-series/O1w & ROLAND Workstations do not to our knowledge at this stage support sysex in .mid files. They have Utility modes which can load sysex files but not in the Midi File format.

Basically this means the files downloadable from our site are not compatible with your workstation. You will have to use a computer to upgrade your unit with this file.

NOVA II KEYBOARD SERIES SPECIFICATION

Synthesis System	Analogue Sound Modelling.
Polyphony	12 Voice (expandable) for the standard Nova II keyboard. 24 Voice (expandable) for the Nova II X keyboard. 36 Voice for the Nova II XL keyboard.
Sound Sources per Voice	3 Oscillators, 2 Ring Modulators and a Noise Generator. (Ring modulators can be swapped for FM modulators on Oscillator 3)
Modulation Matrix	Comprehensive Modulation Matrix with 130 possible routings.
Multitimbral capacity	8 part Multitimbral.
Filter	12, 18 and 24 dB per octave Resonant filter configurable in Low Pass, High Pass and Band Pass modes, plus 9 "Special" dual type filters with modulatable frequency separation. All Filters also feature an overdrive control capable of subtle "Saturation" effects to dirty Overdrive. Filter Bypass mode allows Noise to be independently Filtered and is Ideal for the creation of Drum sounds.
LFOs	2 LFOs capable of oscillating at Audio rates. Syncable to MIDI Clock and Slewable with LFO Delay assignable to Fade in or Fade out characteristics.
Envelopes	3 Envelopes. 1 x ADSR and 2 x D(Delay)ADSR types. All have loopable AD stages and Sustain time and Sustain Rate features. ADR Tracking and Level Tracking are also provided for each Envelope.
Program Effects	Distortion, Comb Filter, EQ, Reverb, Chorus/Flanger/Phaser/Ensemble/Rotary Speaker, Delay and Panning effects for each Program.
Total number of Effects	43 Effects available simultaneously - 7 Effects for each of the 8 Parts of a Performance or Program, plus 1 Global 42 Band Vocoder. Yes you can have a different Reverb on each part, a different Delay on each part, a different Chorus etc.
Vocoder	42 Band Vocoder with Sibilance modes and Spectrum Analiser.
Effects Configurations	18 different Effects Configurations available on each Part of a Performance or Program. Realtime Morphing between Effects Configurations is also possible.
Number of Outputs	6 assignable polyphonic outputs with high quality DACs for each output.
Number of Inputs	2 assignable Inputs with high quality ADCs.
Number of Programs	512 Programs in 4 banks. (512 are pre-programmed with Factory sounds)
Number of Drum Programs	200. (296 Drum sound Programs and 4 Drum effects Program)
Number of Drum Maps	4 Drum Maps of 50 Programs each. (3 of which are pre programmed with Factory sounds)
Number of Performances	256 Performances in 2 banks, (256 are pre-programmed with Factory sounds)
Number of Favourites	128 Favourites in 1 bank.
Arpeggiator	Built in Arpeggiator with 127 Preset Polyphonic, 127 Preset Monophonic and 64 User Programmable Polyphonic and 64 User Programmable Monophonic Patterns with 8 Arpeggiators available simultaneously in Performance mode.
Control	All knobs, switches and Parameters transmit MIDI Controllers and NRPNs.
Operating System	Flash upgradeable operating system via MIDI. Free as a MIDI file on our Web Site.
Power Requirement	Multi Voltage built in power supply. 100V to 240V.
MIDI	In/Out/Thru.
Dimensions	Length 853mm. Depth 298mm. Max height including knobs 95mm.
Weight	8kg

NOVA II SERIES EXPANSION BOARDS SPECIFICATION

(For standard 12 voice and Nova II X version only)

Additional Voices	12 VOICE EXPANSION BOARD. (For standard Nova II models & Nova II X only) 12 Voices This can be fitted to the Nova II keyboard. There is no point in adding this to the Nova II X keyboard as the 12 voice expander card is already fitted.
Additional Voices	24 VOICE EXPANSION BOARD. (For standard Nova II models & Nova II X only) 24 Voices This can be fitted to the Nova II keyboard and Nova II X keyboard. If fitted to the Nova II X keyboard the 12 voice expander card must be discarded and this one installed in it's place. Once installed the polyphony will be 48 voices.



NOTE:

Specification subject to change without prior notice due to improvements.
Release dates of improved Operating Systems is up to the discretion of Novation EMS Ltd.

When the following MIDI bank select messages are sent to the Nova II keyboard the following Modes are selected.



These messages are expressed as the LSB of the MIDI bank message (CC32 data values) only as the MSB MIDI bank message (CC0 data values) are not required to select a new bank.



When a new Mode is selected on the front panel only the LSB bank messages are transmitted.

- 0 - Favourites
- 1 - Perf bank A
- 2 - Perf bank B
- 3 - Perf bank C
- 4 - Perf Bank D
- 5 - Prog bank A
- 6 - Prog bank B
- 7 - Prog bank C
- 8 - Prog bank D
- 9 - Prog bank E
- 10 - Prog bank F
- 11 - Prog bank G
- 12 - Prog bank H
- 13 - Arp bank Mono
- 14 - Arp bank Poly
- 15 - Arp bank User
- 16 - Reserved
- 17 - Reserved
- 18 - Drum Map a
- 19 - Drum Map b
- 20 - Drum Map c
- 21 - Drum Map d
- 22 - Drum Map e
- 23 - Drum Map f
- 24 - Drum Map g
- 25 - Drum Map h

MIDI CONTROLLER TABLE

0 – Bank Select MSB	64 – Sustain / Arp Latch
1 – Modulation Wheel	65 – Arp Latch
2 – Breath Controller	66 – Osc 1 Pitch Env 3
3 – Arp Pattern Select	67 – Osc 2 Pitch Env 3
4 – Ring Modulator 2 * 3 Mix Level	68 – Osc 3 Pitch Env 3
5 – Portamento Time	69 – Osc 1 Width LFO 2
6 – Data Entry	70 – Osc 2 Width LFO 2
7 – Part / Program Volume	71 – Osc 3 Width LFO 2
8 – Effects Config Morph Amount	72 – Filter Res Env 2
9 – Arp Speed (Internal Clock Rate) [*]	73 – Filter Res LFO 1
10 – Pan	74 – Env 3 Delay
11 - Osc 1 Fine Tune	75 – Env 3 Attack
12 - Osc 3 Fine Tune	76 – Env 3 Decay
13 - Osc 1 Soften	77 – Env 3 Sustain
14 - Osc 2 Soften	78 – Env 3 Release
15 – Osc 3 Soften	79 – Env 3 Velocity
16 – LFO 1 Speed	80 – LFO 1 Speed Env 3
17 – LFO 1 Delay	81 – LFO 2 Speed Env 3
18 – LFO 2 Speed	82 – LFO 1 Offset
19 – LFO 2 Delay	83 – LFO 2 Offset
20 – Osc 1 Pitch Env 2	84 – Reverb Mod Wheel Depth
21 – Osc 1 Pitch LFO 1	85 – Filter Res Env 3
22 – Osc 1 Pulse Width	86 – Filter Res LFO 2
23 – Osc 2 Fine Tune	87 – Chorus Speed
24 – Noise Soften	88 – Chorus Mod Depth
25 – Osc 2 Pitch Env 2	89 – Chorus Feedback
26 – Osc 2 Pitch LFO 1	90 – Distortion Level
27 – Osc 2 Pulse Width	91 – Reverb Send Level
28 – Osc 1 Mix Level	92 – Delay Send Level
29 – Osc 2 Mix Level	93 – Chorus Send Level
30 – Noise Mix Level	94 – Chorus Mod Wheel Depth
31 – Ring Modulator 1 * 3 Mix Level	95 – Reverb Decay
32 – Bank Select LSB	96 – Reverb HF Damp
33 – Osc 3 Mix Level	97 – Master Volume Level [*]
34 – Filter Tracking	98 – NRPN Select LSB
35 – Filter Freq LFO 2	99 – NRPN Select MSB
36 – Osc 1 Mix Env 2	100 – Reverb Type / Early Ref Level [**]
37 – Osc 2 Mix Env 2	101 – Delay Time
38 – Osc 3 Mix Env 2	102 – Delay Feedback
39 – Noise Mix Env 2	103 – Delay HF Damp
40 – Osc 3 Pitch Env 2	104 – Filter Overdrive
41 – Osc 3 Pitch LFO 1	105 – Filter Cutoff Freq
42 – Osc 3 Pulse Width	106 – Filter Resonance
43 – Osc 1 Width Env 2	107 – Filter Freq Env 2
44 – Osc 2 Width Env 2	108 – Env 1 Attack
45 – Osc 3 Width Env 2	109 – Env 1 Decay
46 – Osc 1 Width LFO 1	110 – Env 1 Sustain
47 – Osc 2 Width LFO 1	111 – Env 1 Release
48 – Osc 3 Width LFO 1	112 – Env 1 Velocity
49 – Osc 1 Sync	113 – Env 2 Delay
50 – Osc 2 Sync	114 – Env 2 Attack
51 – Osc 3 Sync	115 – Env 2 Decay
52 – Osc 1 Sync Env 2	116 – Env 2 Sustain
53 – Osc 2 Sync Env 2	117 – Env 2 Release
54 – Osc 3 Sync Env 2	118 – Env 2 Velocity
55 – Osc 1 Sync LFO 1	119 – Delay Mod Wheel Depth
56 – Osc 2 Sync LFO 1	120 – All Sound Off
57 – Osc 3 Sync LFO 1	121 – Reset Controllers
58 – Distortion Mod Wheel Depth	122 – Local Control [*]
59 – Filter Freq Env 3	123 – All Notes Off
60 – Filter Freq LFO 1	124 – All Notes Off
61 – Osc 1 Soften Env 2	125 – All Notes Off
62 – Osc 2 Soften Env 2	126 – All Notes Off
63 – Osc 3 Soften Env 2	127 – All Notes Off

Sorry at the time of going to press these tables were unavailable, but will be available on our web site <http://www.novationuk.com> ASAP.



Simply recording any knob movement or button press will enable control via MIDI. Examining this recording will reveal the Controllers/NRPN's identity if specific information is required immediately.

PROGRAM BANK A

0	Sintillator M-Wh	64	Pulsebass
1	Skewed Arp	65	Synth Scratch
2	Softena Bass M-Wh	66	Staccato Filter
3	Velo 303	67	Vienna Bender
4	Velocity Mutes	68	Piki
5	Its Not OK	69	Rez Square M-Wh
6	Garage Kick	70	DetuneBass M-Wh
7	FM EP	71	Randevous 2 harp
8	T-chu Wave	72	Comb Snare
9	Ravin On	73	Arpy 30Dist
10	Velo 303 Dist	74	Hard Bass
11	SyncHeathHazard	75	Prelude
12	Stringz	76	Arp Fingers
13	Garage Organ	77	Sweep 12 dB
14	Synthi Harp M-Wh	78	Strillan M-Wh
15	Square Basics	79	Waterphones
16	Synus M-Wh	80	Pulse Clav M-Wh
17	PunchiPick M-Wh	81	Velo Sync M-Wh
18	Sparkx	82	Burbler
19	Morph Brass M-Wh	83	InVinceable M-Wh
20	Flathead Bass	84	2 Osc Pad
21	U-no polysynth 1	85	Down Osc
22	MW BPF	86	Ana Organ
23	Perc Organ Bass1	87	Sinker M-Wh
24	Pickled on...	88	No FM Huh?
25	Slynkie Slide	89	909 Clap
26	Full Organ	90	Perckie Saw M-Wh
27	Vorsprung...M-Wh	91	Coke Filter M-Wh
28	909 Snare 1	92	Sup Jup Horn M-Wh
29	Pad 4 Landing	93	Clockworks M-Wh
30	DigiTrouserCough	94	Comatose
31	Anafuzzy logik	95	Open High Hat 1
32	Spectra Pad	96	Your Pad or Mine
33	Vindalo Noise	97	Xtal Drop
34	SlapBass1	98	S-ash Tray M-Wh
35	Techno crat	99	Uplifting M-Wh
36	Obie Paddiviv	100	Subbass M-Wh
37	Deadly Sync M-Wh	101	Clix Organ
38	Echoed Maj 3rd	102	Swidge M-Wheel
39	Naked	103	Delicate Arp
40	U-no Bass1	104	Syncapation
41	EP	105	Closed High Hat 1
42	Ambient Line	106	Flange Pad
43	RainPicks	107	X mod Bass
44	No Moralies M-Wh	108	Nova Crash 1
45	Highly Strung	109	Obie Jumpin
46	Westerly Lead	110	Novebella
47	Filth 5th	111	Pianola M-Wh
48	Clock Clang	112	E-Dreamsynk
49	Skwusha 2 M-Wh	113	Poms Bass3
50	Jungle sine	114	Just Cant Get It
51	303 Groover 1 M-Wh	115	Bubble Arp
52	Distillia	116	909 Tom M-Wh
53	Sonar (C3) M-Wh	117	Virtual Panpipe
54	TeaSub Bass	118	Glider 2 Pad M-Wh
55	Bright EP	119	Hard Nosed
56	Brass	120	808 Kick2
57	Eleventh HourPad	121	Piano Pad M-Wh
58	SuperStrings1	122	Raver Pad M-Wh
59	TB1 M-Wh	123	Roundhouse Bass
60	All The Rave	124	Pick 'n' Mix
61	Stack HPF M-Wh	125	Rain Piz
62	Infiltrator SFX	126	Mechatron Arp
63	Cheesy Spice	127	Poms Bass2

0	Filtered H2O	64	SuperBassSt'n 1
1	SuperBassSt'n 19	65	Synth Backslip
2	Width Bass M-Wh	66	Staccato Square
3	Wheel 303	67	Leader
4	Lonely Olive	68	D'you know Pick
5	Z-Plane VeloPick	69	Perci Blip M-Wh
6	Kickin Hardcore	70	Simple Bass 2
7	Giggin EP	71	Snotty Nose
8	U-no Brass	72	Snared
9	Screaming Raver	73	Harmonic Dist303
10	DistortOrgan	74	Hardbasssweep
11	Bigger 1	75	Obie String Pad
12	Polysikz Strings	76	Random Arp
13	Voxi Organ	77	Sweep 24dB
14	Lead Gat	78	Filmskore
15	HolidayLeadBass	79	Liquinova M-Wh
16	Sine-us	80	FM Clav
17	Bottie End	81	VeloReso
18	StaccatoString	82	PVC Pipe/Tom M-Wh
19	Obie Brass	83	Rhythm Sweep
20	Flatter Head M-Wh	84	Pollox pad
21	Synthi Trumpet	85	Self Osc
22	Squeege M-Wh	86	Organ 1
23	Organ Perc Bass2	87	Syncker
24	Don't Pick!	88	Psy1
25	Stab	89	Goes Like Clappr
26	Fuller Organ	90	Perckie Sq M-Wh
27	Hartkern M-Wh	91	Obie Extravert
28	909 Snare 2	92	SupJup BrassM-Wh
29	Devolution M-Wh	93	Throbba M-Wh
30	Modebas M-Wh	94	Wineglass
31	Syn Section M-Wh	95	HiRage Kick M-Wh
32	Spectrux Pad M-Wh	96	Phillharmonic
33	Filter Sweep KHz	97	Obie Tootle
34	SlapBass2	98	Wheelreso
35	Zing a Zing Ahh	99	Slow Sweepa
36	Choral Pad M-Wh	100	2 Osc & M-Wh Sub
37	Messy Sync M-Wh	101	MultiHigh Hat
38	Old'n'Rickety	102	Radar>Comms
39	TB Vac>scene 2	103	Rio Mod Wheel
40	U-no Bass2	104	DistLead
41	Velo Stabber	105	Boogie Lead
42	Dreamy Arp	106	Emerald
43	Ringglass	107	FilterBass M-Wh
44	Handbagin Bass	108	Rubber Filter M-Wh
45	Stringie Thingie	109	Sync Brass Pad
46	Lead 1	110	Tinkerbelle
47	Worry free Pad	111	BP Barker
48	Bell 1	112	Whiteout
49	Garage Swelch	113	Sync & Ring Bass
50	Single Sub Wheel	114	Needle Pick M-Wh
51	303 Groover 2 M-Wh	115	Electro Wire
52	PWM Crunchie	116	Electro Snare
53	Staccato	117	Low Transmitter
54	Simple Bass	118	Electro Guiro
55	Super Nova Tramp	119	Velo 303 Arp
56	Brassic	120	Garage Kick Arp
57	Upstairs@Holgers	121	Simple Bass Arp
58	SuperStrings2	122	SyncSaturation
59	Doh!	123	Tin Can Wire M-Wh
60	Attacka M-Wh	124	Clickie Pickie
61	Xfade HPF	125	Chirpy Novae
62	Explosion	126	Simple Arp M-Wh
63	Pocket stylophone	127	Init Program

PROGRAM BANK C

0	Neuroglider	64	Basse
1	Die Roboter	65	Synth Stop Scratch
2	Bace	66	Staccato Pulse
3	TB Vac>scene	67	Ring on a lead
4	Gated Pad	68	Poppy
5	SupJupVelBrass1	69	Dreamin Pick M-Wh
6	202 Kick	70	ThunderFloorBass
7	Phased EP	71	Synced M-Wh Muck
8	Jubrassic	72	Wabblers
9	Raversiren	73	TB2
10	Powerchord	74	PsyGrund
11	Lead or Bass	75	Airy Fairy
12	Smooth Strings	76	Ring Rise
13	Breath Dist	77	7th Machine
14	ElectroStratGat	78	Film Pad
15	Drubex SQ	79	Tubus
16	Softena	80	Clavi
17	Nasty Bass	81	MW Cut
18	Clickspace	82	Mallet
19	Jupiter Slapper	83	Jazzier Lead Gat
20	Fathead	84	Pad Sweep
21	U-no polysynth 2	85	Starfall
22	Zumph	86	Pianova
23	Garage Organ Bass	87	Simple Sync
24	Sass Pick	88	Psy2
25	7th Stak	89	D'you know Sq
26	ClickOrgan	90	Perckie Pulse M-Wh
27	Dutch M-Wh	91	PS_ Strings 7th
28	SnareDrummer	92	Echoed Strings
29	Glider	93	Syncrodrone
30	U-no Sub	94	MusicBox
31	Its OK as it is	95	Hi Hat (Open)
32	Inverse Square	96	SoftStrings
33	Velo Spitz	97	Pluck Knows M-Wh
34	SlapBass3	98	Deep Lord
35	Zing Leak	99	Nova Railway M-Wh
36	Plated analogue	100	Crystal Shimmer MWh
37	Synk	101	Force Field
38	Unison DaDaDaa	102	Science lab
39	Sass!	103	Madness 303
40	Zap Bass	104	Jazz Guitar
41	Sanxion Filtered	105	Hi Hat (Closed)
42	Heavenly Slide	106	Strung Up
43	Ring>Vince	107	Poms Bass4
44	Simpler Bass	108	Noisik
45	Sollie strings 1	109	Downsweep
46	Sync Lead M-Wh	110	Downloading
47	Smack M-Wh	111	Obie Wurlie
48	JDee Bell	112	S&H Noise
49	R'n'B Glide M-Wh	113	SyncBass
50	Pulsering Bass	114	Needle Pulse M-Wh
51	Ring Riser	115	Alienoiz1
52	Syncronicity	116	909 Snare 1 Arp
53	Alienoiz1	117	909 Clap Arp
54	Bass4	118	Kickin
55	Whirly	119	Closed H-Hat1Arp
56	Swishi	120	Spectrum
57	PurrFlange	121	Synth Cymbals
58	Formant Saw Pad	122	Saturated Square
59	TB Poly Arp	123	Trans Euro Exprs
60	Our Friend PWM	124	Seq Nova M-Wh
61	Cykokinetic M-Wh	125	Alienoiz2
62	Komb Noise	126	Arp Sync M-Wh
63	Whistle	127	Simplest Bass

0	Synced Formant 1	64	Max Bass
1	Sawtooth Seq. jh	65	Communicator
2	Click Bass M-Wh	66	Xpander 2000 jh
3	Trance4 M-Wh	67	FiltaMatrix M-Wh
4	SimpleEnvVeloArp	68	Fin Pluck it!
5	"I"	69	FM Bell Lead
6	909 Kick	70	Wart Bass
7	Metal Knoll	71	ComeToDance M-Wh
8	Slide Brass M-Wh	72	FM Lead 1
9	Gritty Program	73	Hard Cheese M-Wh
10	Soft Brit Sound?	74	In-Your-Ear M-Wh
11	Uni*Syn	75	Strings'R'Talkin
12	ItsKindaPhasedWh	76	NeedleBleep M-Wh
13	House Organ jh	77	Gusset Pad M-Wh
14	BP 303 2	78	EuphoricNag M-Wh
15	Given Bass M-Wh	79	Gated Noise M-Wh
16	Ahh Voices 2	80	AnaKey M-Wh
17	VeloQuack	81	Synced
18	Ballsy Anal-Log!	82	FM Block
19	Electric Insect	83	Dat D'n'BassM-Wh
20	Drum'n'BassBass	84	Soft Pad
21	Synth Sektor FX	85	Tranceypants
22	LFO madness	86	BP Organ
23	SimpleAnaBass-Wh	87	Plug'n'Sync jh
24	Pinchi Pick M-Wh	88	Sqaurx M-Wh
25	FM Glockenspiel	89	Kraft M-Wh
26	DontSurrender-Wh	90	Tottie Arp
27	TecknoTecknoM-Wh	91	Lush
28	909 Snare	92	3'0'Trance 1
29	Vector Pad	93	Funk WahWah M-Wh
30	Juice Bass	94	Polynova 3
31	Grunge Pick M-Wh	95	Iridium
32	Orbit Pad M-Wh	96	Phase Strings jh
33	FM Sweep jh	97	Bottle Arp
34	Pick Bass M-Wh	98	Buzz Bass
35	Talker	99	Fin Mono Arp 1
36	Strings Ens	100	Low Bass
37	Sync it M-Wh	101	Show U the Organ
38	A To B PB-Wh	102	Drum'n'Bass 3
39	BP 303 M-Wh	103	Trance7 M-Wh
40	SoloAnaTrumpet	104	Clean'n'Clear jh
41	FM Piano/Guitar	105	Aggrosweeper
42	Chatter Arp M-Wh	106	1osc pad
43	ModW Surprise jh	107	BasikBass
44	Dance Bass	108	3'0'Trance 2
45	DualFiltStringWh	109	Dark Talker
46	VeloUniSync	110	Trance Bass M-Wh
47	"EEW"	111	Trance1 M-Wh
48	FM Marimba	112	Low Organ
49	Trance6 M-Wh	113	Bottie Bass
50	Reso Bass	114	FM Bass
51	Gated Noise M-Wh	115	FMpt Xylo Lo
52	Growla BP303M-Wh	116	FMpt Xylo Hi
53	Scammy Chord	117	Orgpt ClikLo Dry
54	Boot Bass	118	Orgpt DX Lo Dry
55	AnaPiano M-Wh	119	Orgpt DX Hi Dry
56	Bottled Genie	120	FMpt RhodeDt Wfx
57	Ahh-Yeah M-Wh	121	FMpt RhodeBd Wfx
58	DualFiltPWMingWh	122	FMpt RhodeTn Wfx
59	BlubberPick M-Wh	123	Pulse VocoderIn1
60	BowedMetal M-Wh	124	Vocoder In 1
61	ThrobiMemberM-Wh	125	Input/sw1Program
62	Winge Forum M-Wh	126	FM Init Program
63	Trance2 M-Wh	127	2 Osc Init M-Wh

DRUM MAP A

- 0 909 Kick 2
- 1 Rim Shot
- 2 808 Snare 2
- 3 808 Clap
- 4 909 Snare
- 5 Electro Low Tom 1
- 6 Closed High Hat 1
- 7 Electro Low Tom 2
- 8 Closed High Hat 2
- 9 Electro Mid Tom
- 10 Open High Hat 1
- 11 Electro Hi Tom 1
- 12 Electro Hi Tom 2
- 13 Crash Cymbal 1
- 14 Crash Cymbal 3
- 15 Crash Cymbal 4
- 16 909 Clap 3
- 17 909 Low Tom 1
- 18 808 Closed HiHat
- 19 909 Low Tom 2
- 20 808 Cowbell
- 21 909 Mid Tom
- 22 808 Open HiHat
- 23 909 Hi Tom 1
- 24 909 Hi Tom 2
- 25 808 Kick Click L
- 26 808 Low Conga
- 27 Noisy Kick
- 28 808 Mid Conga
- 29 808 Hi Conga
- 30 Snova2 Kick5
- 31 808 Low Tom
- 32 Snova2 Kick4
- 33 808 Mid Tom
- 34 808 Maracas
- 35 808 Hi Tom
- 36 808 Kick Click
- 37 Dodger Rodger
- 38 Noisy Kick 1
- 39 808 Clave
- 40 FM Block
- 41 Bottle
- 42 Simple Low Conga
- 43 Simple Mid Conga
- 44 Simple Hi Conga
- 45 Snova Kick5
- 46 Snova2 Kick4
- 47 Snova2 Kick3
- 48 Snova2 Kick2
- 49 General kit 1 FX

0	909 Kick 2
1	Rim Shot
2	808 Snare 2
3	808 Clap
4	909 Snare2
5	Electro Tom 5
6	Closed High Hat 3
7	Electro Tom 4
8	Closed High Hat 4
9	Electro Tom 3
10	Open High Hat 2
11	Electro Tom 2
12	Electro Tom 1
13	Crash Cymbal 1
14	Crash Cymbal 2
15	Ride Cymbal
16	Clap 3
17	Disco Tom 5
18	808 Closed HiHat
19	Disco Tom 4
20	808 Cowbell 2
21	Disco Tom 3
22	808 Open HiHat
23	Disco Tom 2
24	Disco Tom 1
25	808 Kick Click L
26	808 Low Conga
27	808 Snare
28	808 Mid Conga
29	808 Hi Conga
30	Snova2 Kick1
31	Garage Snare 4
32	Breakdown Kick
33	Velo Spitz
34	Maracas 2
35	Electro Guiro
36	Synth Scratch
37	Sonar
38	Synth Backslip
39	808 Clave 2
40	Wah 4
41	Wah 3
42	MultiHigh Hat
43	Wah 2
44	Hi Hat (Closed)
45	Wah 1
46	Hi Hat (Open)
47	909 Kick + Click
48	808 Kick No Clk
49	General kit 2 FX

DRUM MAP C

- 0 Res FX 1
- 1 Wip 1
- 2 Res FX 2
- 3 Force Field 2
- 4 Res FX 3
- 5 Res FX 4
- 6 Vindaloo Noise
- 7 Spit U Like M-Wh
- 8 RainPicks
- 9 Spit U Like2M-Wh
- 10 Infiltrator SFX
- 11 Burbler
- 12 Down Osc
- 13 Rain Piz
- 14 Filter Sweep KHz
- 15 Ringglass
- 16 Explosion
- 17 Liquinova M-Wh
- 18 Self Osc
- 19 Radar>Comms
- 20 Whiteout
- 21 Low Transmitter
- 22 RaverSiren
- 23 Ring>Vince
- 24 Wabbler
- 25 Tubus
- 26 Force Field
- 27 Sience Lab
- 28 Downloading
- 29 LFO Madness
- 30 Res FX 10
- 31 Res FX 11
- 32 Noise Sweep
- 33 Velo Spitz M-Wh
- 34 Noise Sweep 1
- 35 Noise Sweep 3
- 36 Noise Sweep 4
- 37 Noise Sweep 5
- 38 REZ1
- 39 REZ2
- 40 REZ3
- 41 Noise Sweep 6
- 42 CHIRP 1
- 43 CHIRP 2
- 44 CHIRP 3
- 45 CHIRP 4
- 46 CHIRP 5
- 47 CHIRP 6
- 48 CHIRP 7
- 49 SFX Kit FX

0 Init Program
1 Init Program
2 Init Program
3 Init Program
4 Init Program
5 Init Program
6 Init Program
7 Init Program
8 Init Program
9 Init Program
10 Init Program
11 Init Program
12 Init Program
13 Init Program
14 Init Program
15 Init Program
16 Init Program
17 Init Program
18 Init Program
19 Init Program
20 Init Program
21 Init Program
22 Init Program
23 Init Program
24 Init Program
25 Init Program
26 Init Program
27 Init Program
28 Init Program
29 Init Program
30 Init Program
31 Init Program
32 Init Program
33 Init Program
34 Init Program
35 Init Program
36 Init Program
37 Init Program
38 Init Program
39 Init Program
40 Init Program
41 Init Program
42 Init Program
43 Init Program
44 Init Program
45 Init Program
46 Init Program
47 Init Program
48 Init Program
49 Init Program

PERFORMANCE BANK A

0	Blaster Master	64	Juicy Gaff
1	Pad on Spec	65	Agro Pad
2	Tech Terror	66	Ambi Bambi
3	Liquid Goo	67	Solaris
4	Layered Pianos	68	Perci Organ
5	SuperStabber	69	Brass+Lead
6	Popsickle	70	TooPad
7	SintillatedWorry	71	Chime On
8	Cool Pad	72	Choccie
9	The Pizzacato	73	PaddiWhack
10	Klavikle	74	OrchStrings
11	Ravers in 7th!	75	Liquid Sweep
12	Donna Supernova!	76	Classic Combo
13	AbsoluteMassive	77	Multimode BPF
14	The Glide	78	Annialator
15	Skwelchi 7th	79	Masterbasse
16	Electric Aaah	80	Swept
17	Hypersynus	81	Analogue Bleep!
18	Ambient Nation	82	Synced Clavinux
19	Brass Section	83	Tinkler
20	HardToTheKore!	84	The Three Arps
21	Pink Phycosis	85	Synced Twice
22	Fatty	86	I Feel Funky
23	Naked String	87	A Bunch Obiewan
24	TwinOvaHead303's	88	Staccato Square
25	Puff Pipe	89	Worry Free
26	Deep Strings	90	Ambient Groover
27	SupSupSupJup	91	Twin Organ
28	Pionus	92	Lead & Pad
29	Worry Free	93	2ForkinRavers
30	Conetik	94	Synth Strings
31	Layered Spectra	95	Agro Pad
32	Novestra	96	Psy Pad
33	Kit 1	97	7th Heaven
34	EP & Strings	98	3rd & 7th
35	String+PluckLead	99	Perky Synth Pad
36	Good Ole 80's	100	MooZ At 72ooz..
37	Filming in Space	101	Staccato Saw
38	AttackVelo-Chord	102	Blip & Co
39	Probe	103	Trouser Fat
40	3rd Party Pad	104	Invert Filta Pad
41	Two Big Ones	105	Perci Fellow
42	Trance Nation	106	Flutter Pad
43	Morphwave	107	Liquid Sweep
44	Synth Section	108	JammyLoop
45	LiquidNarcotic	109	When U Wanna...
46	Piano+Pading	110	Chimez
47	1 Finger LSO	111	Layered Sweeps
48	Teci	112	TinCanDiffusion
49	Fantasam	113	Brass Section 2
50	Tingly & Drugged	114	Endless Arps
51	Sync's 'R' Us!	115	Atmospherics
52	Layered Pianos 2	116	Super Unisyn 2
53	Super Fat	117	Twin Organ 2
54	Squelchie	118	Kit 2
55	Heaven OrganPad	119	The Pizzacato 2
56	Super Unisyn	120	Padnus
57	Space Pad	121	Layered Neuro
58	PiciGater Pad	122	The Strings
59	Multimode BPF	123	Init Velo Xfade
60	2 Nasties	124	Init VeloSw V110
61	Lead & H20	125	Init Split at C3
62	Minor Evil	126	Multi Ch 1-8
63	Botty & Sparks	127	Init Perf

0	Energy Rusher!	64	Pianas Pad
1	SQ Law	65	SuperObiewan 2
2	Enormous 5th	66	Syncathetic
3	SuperUtopian	67	3 Slappa Bass
4	Plastic Crackpot	68	A Pile of Perf
5	FM Rhodes 3PtWfx	69	AtmosSpace
6	Can Basher!	70	SuperHard
7	The Dark Horse	71	SuperSaturated
8	News & Weather	72	Slow'n'Slippery
9	SuperGlider	73	Picked Gat/Harp
10	On Your Face	74	Arty Farty
11	SuperMorph Brass	75	Slow Pad
12	Euphorik Trancer	76	NetherUltraPulse
13	Ole Genes	77	SuperNeuro
14	Crystal SQ	78	Tranzlator
15	SuperSpectra	79	Stereo HardHouse
16	SuperDutch	80	Sync Knife
17	SuperT-chu	81	5th Padie
18	The Profecy!	82	Cimmie Pad
19	HyperSpace	83	Kit 4 (FX)
20	WavS'tion	84	Crankie Says
21	Supa PolyNova 1	85	Supa Sync Bass
22	Supa Piana	86	Plucky Tchu
23	SuperObiewan	87	Comp 1
24	Dub'n'Basic!	88	BuzzyBrass
25	FM Xylophone	89	SlightlyDirtyOrg
26	Cave Trippy	90	Glided Arps
27	No FX Strings	91	Supa Sync Lead
28	SuperSynthi Harp	92	Phatt&Wiffy
29	FM Organ	93	SuperHealth Haz
30	Con-figed Arps	94	Master Psy
31	SuperGlider 2	95	Synk Hit
32	Evolution	96	Bouncy Castle
33	SuperLucky	97	SuperEclipse
34	Tink	98	Don't Be Pickie
35	SuperPhattie	99	SuperBrillo
36	Minor Event	100	Strangely
37	FM Click Organ	101	SuperSimple Sync
38	Transwave	102	Hard'n'Fast
39	Big Bast**d	103	SuperSyncapation
40	2 Giggers	104	Elect Guitar
41	SuperPulse 5th	105	Mellow Man
42	Petz'R'Us!	106	Percy
43	Sq Chorrals	107	Super Attacka
44	Kit 3	108	Towel Fetish
45	SuperExtravert	109	SuperNics
46	SuperPunch Pick	110	Metaloid
47	SuperBrass	111	SuperSync Pad
48	Cruiser!	112	SuperRickety Syn
49	Spit Bass	113	SuperSyncer
50	Supa PolyNova 5	114	Trippy 9/8
51	SuperStringz	115	SuperTouchie 2
52	SuperPianopad	116	SuperWesterly
53	SuperStrillan	117	SuperBarker
54	Dirty Arps	118	SuperSlapper
55	Wet Sintillation	119	Irradiated Blast
56	Elles Bells	120	Init Perf PartFX
57	SuperBrassik	121	MultCh1-8 PartFX
58	SuperTouchie 1	122	MultCh9-16PartFX
59	SuperSyn Trumpet	123	InitNorm/InvVelo
60	Dub'n'Basser!	124	Init VeloSw V100
61	PluckinNoseHair	125	Init Split at C2
62	Multi Bleep	126	Multi Ch 9-16
63	SuperChoral	127	Demo

MONOPHONIC PRESET PATTERNS

0	UP	64	3/3 Up Slightly Accented
1	DOWN	65	3/3 Dn Accented
2	UP & DOWN1	66	3/3 Dn Slightly Accented
3	UP & DOWN2	67	3/3 Up/Dn Accented
4	PLAYED	68	3/3 Up/Dn Slightly Accented
5	WALKINGUP	69	9/8 Pattern Accented
6	WALKINGDOWN	70	9/8 Pattern Slightly Accented
7	WALKINGPLAYED	71	Walking Up2 Accented
8	RANDOM1	72	Walking Up2 Slightly Accented
9	RANDOM2	73	Walking Dn2 Accented
10	RANDOM3	74	Walking Up2 Slightly Accented
11	TB1	75	Walk Up/Dn2 Accented
12	TB2	76	Walk Up/Dn2 Slightly Accented
13	TB3	77	Walk Dn/Up2 Accented
14	TB4	78	Walk Dn/Up2 Slightly Accented
15	TB5	79	Walk3 Up Accented
16	TB6	80	Walk3 Up Slightly Accented
17	TB7	81	Walk3 Dn Accented
18	TB8	82	Walk3 Dn Slightly Accented
19	TRANCE1	83	House 1 Accented
20	TRANCE2	84	House 1 Slightly Accented
21	TB9	85	Walk Accented
22	TB10 UP	86	Walk Slightly Accented
23	TB11 DN	87	MUSO 2 Accented
24	TB12 UP/DN	88	MUSO 2 Slightly Accented
25	TRANCE BASS1	89	Shuffle Accented
26	TRANCE BASS2	90	Shuffle Slightly Accented
27	TB13	91	80's 2 Accented
28	TB14	92	80's 2 Slightly Accented
29	TB15	93	80's 3 Accented
30	TB16	94	80's 3 Slightly Accented
31	TB17	95	C52's Accented
32	TB18	96	C52's Slightly Accented
33	80'S 1	97	C52's Variation Accented
34	TB GLIDE1	98	C52's Variation Slightly Accented
35	TB19	99	Walking up 1 Accented
36	TB GLIDE2	100	Walking up 1 Slightly Accented
37	TB GLIDE3	101	Walking Dn 1 Accented
38	TB20	102	Walking Dn 1 Slightly Accented
39	Muso 1 Accented	103	Walking Up/Dn Accented
40	Muso 1 Slightly Accented	104	Walking Up/Dn Slightly Accented
41	Trill Dn Accented	105	Walking Dn/Up Accented
42	Trill Dn Slightly Accented	106	Walking Dn/Up Slightly Accented
43	Trill Up Accented	107	Techno Accented
44	Trill Up Slightly Accented	108	Techno Slightly Accented
45	Trill Dn/Up Accented	109	Techno Accented
46	Trill Dn/Up Slightly Accented	110	Techno Slightly Accented
47	Trill Up/Dn Accented	111	UPUPUPDN
48	Trill Up/Dn Slightly Accented	112	UPUPDNUP
49	Rave 1 Accented	113	UPDNUPUP
50	Rave 1 Slightly Accented	114	DNUPUPUP
51	Rave 2 Accented	115	DNDNUPUP
52	Rave 2 Slightly Accented	116	DNDNDNUP
53	Shimmie Accented	117	DNDNUPDN
54	Shimmie Slightly Accented	118	DNUPDNNDN
55	Running Up Accented	119	UPDNNDNDN
56	Running Up Slightly Accented	120	UPDNNDNUP
57	Running Dn Accented	121	DNUPUPDN
58	Running Dn Slightly Accented	122	HARM UP1
59	R'ning Up/Dn Accented	123	HARM UP2
60	R'ning Up/Dn Slightly Accented	124	HARM UP3
61	R'ning Dn/Up Accented	125	HARM DN 1
62	R'ning Dn/Up Slightly Accented	126	HARM DN2
63	3/3 Up Accented	127	HARM DN3

0	Bass Trance 1	64	BASS5
1	303 Trance 1	65	BASS6
2	303 Trance 1v1	66	BASS7
3	303 Trance 2	67	BASS8
4	Bass Trance 2	68	BASS9
5	303 Trance 3	69	BASS10
6	303 Trance 3v1	70	BASS11
7	303 Trance 4	71	BASS12
8	303 Trance 4v1	72	BASS13
9	303 Trance 5	73	BASS14
10	UP DN Variation	74	BASS15
11	303 Trance 6	75	BASS16
12	Minor UP DN	76	BASS17
13	Bleep 1	77	BASS18
14	Bleep 2	78	BASS19
15	Bleep 3	79	BASS20
16	Bleep 4	80	TECHNO1
17	Bleep 4v1	81	TECHNO2
18	Bleep 5	82	TECHNO3
19	Bleep 6	83	TECHNO4
20	UP DN Runner	84	TECHNO5
21	Bleep 7	85	TECHNO6
22	Bleep 8	86	TECHNO7
23	Bleep 9	87	TECHNO8
24	303 Trance 7	88	TECHNO9
25	Bleep 10	89	TECHNO10
26	Bleep 11	90	TECHNO11
27	Bleep 12	91	TECHNO12
28	303 Trance 8	92	TECHNO13
29	303 Trance 9	93	TECHNO14
30	303 Trance 10	94	TECHNO15
31	Bleep 13	95	TECHNO 16
32	303 Trance 11	96	TECHNO 17
33	Bleep 14	97	TECHNO 18
34	303 Trance 12	98	D-D-DAA
35	303 Trance 12v1	99	D-D-DAA2
36	303 Trance 12v2	100	DADADADA
37	303 Trance 12v3	101	DADADA2
38	Bass Trance 3	102	OHH
39	Bass Trance 4	103	CHH
40	NAG1	104	BD
41	NAG2	105	Bass lick
42	NAG3	106	Octave Pulse
43	NAG4	107	Nag 10
44	NAG5	108	Nag 11
45	NAG6	109	Nag 12
46	NAG7	110	Nag 13
47	NAG8	111	Nag 14
48	NAG9	112	Nag 15
49	DNDNDNUP	113	Nag 16
50	DNDNUPDN	114	Nag 17
51	DNDNUPDN2	115	Nag 18
52	DNDNUPUP	116	Nag 19
53	DNUPDNDN	117	Nag 20
54	DNUPUPUP	118	Nag 21
55	UPDNDNDN	119	Nag 22
56	UPDNUPUP	120	Nag 23
57	UPUPDNDN	121	Nag 24
58	UPUPDNUP	122	Nag 25
59	UPUPUPDN	123	Nag 26
60	BASS1	124	Nag 27
61	BASS2	125	Nag 28
62	BASS3	126	Nag 29
63	BASS4	127	Nag 30

DISTRIBUTORS

Please contact your local Distributor for any Service & Warranty issues & Technical Support.

AUSTRALIA

Innovative Music Australia Pty
1st Floor
17-33 Market Street
South Melbourne
Victoria 3205
Ph 00 61 3 9696 6669
stevels@innovative.com.au

AUSTRIA

KS Music Kindler & Stiegler OHG
Marktpassage 1/Top B3D A-8724
Spielberg
Austria
+43 (0) 3512/44344
www.ksmusic.at
info@ksmusic.at

CANADA

Novation USA Ltd
A4 Westacott Business Centre
Maidenhead Office Park
Maidenhead
Berks
SL6 3RT
00 44 628 828880
www.novationuk.com
sales@novationuk.com

CHINA

Central Music Co.
P.O. Box 1860
Beijing
P.R.China
Ph 010 65129131
cme@public3.bta.net.cn
www.centrmus.com

CROATIA

Music Exports GmbH
Lindwurmstrasse 211
D-80337 Munich
Germany
Ph 00 49 89 746 12390

CZECH REPUBLIC

K-Audio Impex
Konzumni 643/10
Prague 9
Hloubetin
19800
Czech Republic
Ph 00 420 2 666 10 529
www.k-audio.cz
kaudio@pvtnet.cz

DENMARK

New Musik (Orange)
Vesterport 8 DK - 8000
Arhus C
DENMARK
Ph 00 45 86 190899
www.newmusik.dk
info@newmusik.dk

FINLAND

F-Musiikki OY
Juvan Teollisuuskatu 25
FIN SF 02920 ESP00
Helsinki
FIN SF 02920 ESP00
Ph 00 358 9 6185 11
www.f-music.com
tomas.lindqvist@f-music.com

FRANCE

Studiotech (Musikengro)
ZAC Lieu dit des Follieuses
Les Echets
01706 Miribel
France
Ph 00 33 1 3960 0271
www.studtech.com
studiotech@wanadoo.fr

GERMANY

TSI GmbH
Neustrasse 9-12
D-53498 WALDORF
Germany
Ph 00 49 2636 97640
www.tsi-gmbh.de
info@tsi-gmbh.de

GREECE

V Dimitriadis & Co Ltd
20 Alexandras Ave
Athens 106 82
Ph 00 30 1 823 2415
http://www.dimitriadiscorp.gr
dimitriadis@athena.domi.gr

HONG KONG

Haupton Company Systems for
Music
G/F., 14 Nanking Street
Yaumatei Kowloon
Hong Kong
Ph 00 852 2780 4864
haupton@hk.super.net

ICELAND

Samspil sf
Skipholt 21
105 REYKJAVIK
Iceland
Ph 00 354 562 2710
www.centrum.is/samspil
samspil@centrum.is

ISRAEL

Marom Musical Instruments Ltd
68 Pinsker Street
Tel Aviv 63568
Israel
Ph 00 972 3 6298236
maromltd@actcom.co.il

ITALY

Backline Srl
Via Dell' Aprica 16
20158 Milano
Milan
Ph 00 39 02 6901 5709
mcristina@backline.it

JAPAN

Select International
8-2 Kitakokubun 1-Chome
Ichikawa
Chiba Pref
Ph 00 81 473 740792
select@green.ocn.ne.jp

MEXICO

Energia En Sonido S.A. de C.V.
(Wise Music)
Agua 719 Col.
Jardines del Pedregal
Mexico D.F. 01900
MEXICO
Ph 0052 5 568 0905
yayo@intertepoz.com

NEW ZEALAND

South Pacific Music Distrib (Mainline
Music)
42 Taharoto Road
Takapuna
Ph 00 64 9 486 2285
www.gurulounge.com
roger@mainline-music.co.nz

NORWAY

Benum
PO Box 145
Vinderen
Norway
Ph 00 47 63 84 33 30
www.beum.no
info@beum.no

POLAND

Contact Head Office Ph 0044 1628
828888

PORTUGAL

Afonso + Bastos
C C Italia loja 19
Rua Julio Dinis 752
4050-012 PORTO
Ph 00 351 2 6099726
www.danceplanet.com
info@danceplanet.com

REPUBLIC OF IRELAND

Soundhouse
Tallview Ltd T/A
7 Crow Street
Temple Bar
DUBLIN 2
Ph 00 353 1 671 9347
soundhse@finet.IE

RUSSIA

Contact Head Office Ph 0044 1628
828888

SOUTH AFRICA

Hohner South Africa Pty
PO Box 1016
Randburg 2015
Johannesburg
Ph 00 27 11 792 8402
www.tuerkmusic.co.za
hohner@hot.co.za

SOUTH KOREA

Midi Land Co
Rm 328 Nakwon Building
284-6 Nakwon-Dong
Chongno-Ku
Ph 00 82 2 765 8637/8
www.midiland.co.kr
midiland@uriel.net

SPAIN

Diagonal Music Center
Pasaje Marimon 10
08021 Barcelona
Barcelona
Ph 00 34 93 201 55 99
www.dmc-music.com
info@dmc-music.com

SWEDEN

Musikmania
Offergatan 30
21125 MALMO
Malmo
21125 MALMO
Ph 00 46 40 25 85 75
www.musikborsen.se
malmopro@musikborsen.se

SWITZERLAND

Musikengros Gutter
Weiermattweg 33
4452 ITINGEN
Itingen
Ph 00 41 61 971 3757

TURKEY

Motif Elektronik
Galipdede Cad No 48
17 Birlik Apt
Giris Kat 80050 Tunel
Istanbul
Ph 00 90 212 293 1068
Bahadir_3@hotmail.com

USA

Novation USA Ltd
A4 Westacott Business Centre
Maidenhead Office Park
Maidenhead
Berks
SL6 3RT
00 44 628 828880
www.novationuk.com
sales@novationuk.com

- 1 Oct - Button 68
- 1*3 - Button 71
- 1*3 - FM - Button 71
- 12dB - Button 86
- 18dB - Button 86
- 2 Oct - Button 68
- 2*3 - Button 71
- 2*3 - FM - Button 71
- 24dB - Button 86
- 3 Oct - Button 68
- 4 Oct - Button 68
- A**
- ABOUT DRUM MAPS 24
- ABOUT EFFECTS 18
- ABOUT FAVOURITES 27
- ABOUT PERFORMANCES 25
- ABOUT PROGRAMS 23
- ADAT Optical In and Out Connectors 3
- ADVANCED SETUP 5
- Aftertouch 69, 85, 92, 98, 129
- AMPLIFIER 11
- Analogue Sound Modelling™ 22
- ANALOGUE SYNTHESIS 6
- Arp pattern editing via kbd 56
- Arp trans chan 51
- Arp trans ref 51
- Arp Transpose Reference Note 51, 64
- Arpeggiator 23, 26, 31, 35, 56, 57, 61
- Arpeggiator real-time transpose channel 51
- Arpeggiator Section 2, 61
- Arpeggio notes to: 66
- ASSIGNING FAVOURITES 28
- AT LFO1 amt 69
- AT speed mod 92
- Attack 13, 99, 100, 102, 103
- Attack - Slider (All Envelopes) 104
- Attack time 12
- Audio in 52, 53
- Audition 121
- AutoGlide 74
- Aux 1 3
- Aux 2 3
- Aux 3 3
- B**
- BACK PANEL 3
- Band - Button 86
- Band Pass Filter 10, 87
- Bank 33, 34, 38, 41, 43, 54, 55
- Bank change message 129
- Bank messages 137
- BASIC SETUP 4
- Breath Control 50
- Breath mode 50
- Breath sensing 50
- Bypass - Button 119
- Bypass - Effects 119
- C**
- category 39, 47
- Cents - Knob 72
- Chorus 20, 108, 109, 110, 111, 119
- Chorus - Button 105
- Chorus Speed 20
- Chorus/Flanger 20
- Clipping 104
- Comb Filter 18
- Compare 38, 43, 44, 47
- Config - Button 105
- Config - Button & Level/Balance - Knob 111
- Config morph 113
- Constant gate 97
- Constant Gate - Button 95
- Constant pitch 36, 66
- CONTENTS 1
- Controller message filter 125
- controller messages 54, 125
- Copy 71
- Copy - Button 71, 119
- Copy part effects to program effects 120
- Copy program effects to part effects 119
- copying of the effects settings 119
- Cross Modulation 8
- Current 28
- Cutoff Frequency 10, 84, 85, 87, 89
- D**
- Data - Knobs 58
- DCO 75
- Decay 13, 99, 100, 102, 103
- Decay - Slider (All Envelopes) 104
- Decay time 12
- Delay 20, 106, 109, 111, 119
- Delay - Button 105
- Delay - Knob 93
- Delay - Knob (ENV 2/3) 103
- Delay fade 92
- Delay HF damp 107
- Delay Ratio 21, 106
- Delay Time 21, 106
- Delay trigger 93
- Delay Whee 107
- Demo 4
- Destination 76
- display 55, 58
- Display section 2, 58
- Distort/EQ 113
- Distort/EQ - Button 105
- Distortion 18, 114, 119
- Distortion curve 114
- Distortion effect 113
- Distortion wheel 114
- Distributors 152
- Down - Button 67
- Drum Map 22, 24, 33, 34, 40
- Drum Map a 144
- Drum Map b 145
- Drum Map c 146
- Drum Map d 147
- Drum played as 40
- Drum Program 122
- Drum Program tuning 122
- dump 49, 55
- E**
- Each 44
- Early ref level 107, 108
- EDITING & WRITING PERFORMANCES 41
- EDITING & WRITING PROGRAMS 38
- Effects 18, 24, 31, 105
- Effects Configuration 105, 111, 113
- Effects Section 2, 105
- Ensemble 19, 20, 73, 75, 108, 109, 110, 111
- Env 1 99
- ENV 1 - Button 103
- Env 1 A-D repeat 100
- Env 1 ATouch 98
- Env 1 key track 99
- Env 1 level note 99
- Env 1 level track 99
- Env 1 MWheel 98
- Env 1 sustain rate 100
- Env 1 sustain time 101
- Env 1 velocity 98
- ENV 2 77, 78, 80, 81, 82, 89, 90, 101
- ENV 2 - Button 77, 78, 80, 81, 82, 89, 90, 103
- Env 2 A-D repeat 102
- Env 2 level note 101
- Env 2 level track 101
- Env 2 sustain rate 102
- Env 2 sustain time 102
- Env 2 velocity 101
- ENV 3 77, 78, 80, 81, 83, 89, 90, 102
- ENV 3 - Button 78, 80, 81, 83, 89, 90, 103
- Env 3 A-D repeat 103
- Env 3 key track 102
- Env 3 level note 103
- Env 3 level track 102
- Env 3 sustain rate 103
- Env 3 sustain time 103
- Env 3 velocity 102
- Envelope 98
- Envelope Attack - Decay Repeat 13
- Envelope Delay 103
- Envelopes section 2, 98
- EQ 18
- Expansion Boards 136
- Exponential 73
- Expression Pedal 53
- External 127
- External - Button & MIDI - Button 129
- External - Button & Range - Button 131
- External - Button & Tune - Button 127
- External - Button & Velocity - Button 128
- External bank LSB 130
- External bank MSB 130
- External highest note 131
- External lowest note 131
- External Mod wheel 130
- External part MIDI channel 129
- External part semitone transpose 128
- External program number 130
- External song select 131
- External velocity max 128

External velocity min 128
External volume level 130

F

Factory Demo 4
Factory settings 52
Factory sounds 38
Favourites 22, 27, 28, 29, 30, 33, 52, 55, 59, 62
Favourites - Deleteing 30
Feedback 21, 106
Fill In 35, 37, 65, 68
Filter 96
Filter Modulation Matrix 88
Filter Modulation Matrix Section 2
Filter Section 2, 84
Filter tracking 84
Filter type 87
Filter width 86
Find 55
Find - Button 47
Finder 47, 55
Finder demos 55
Flanger 108, 109, 110, 111
FM 15, 71, 99, 101, 102
Footswitch 52, 53, 67, 124, 125
Formant 86, 87
Formant Width 7, 8, 10, 70
Fq AT amt 85
Fq AT LFO2 amt 85
Fq MWh LFO2 amt 84
Frequency 6
Frequency - Knob 87
Frequency Mod- Knob 89
FRONT PANEL 2

G

Gain 96
Gain compensate 114
Gate 35, 36, 57, 68, 113
Gate time - Knob 68
Gating 97
Glide 35, 37, 57
Glide type 74
Glissando 73
Global - Button 48
Global MIDI Channel 33, 34, 48
Global Mode 48

H

Harden 8, 10, 82
Harden - Button 83
Harden - Button 82
Hardness Effect 22
Harmonics 6, 15
Headphones - Socket 3
HF damp 108
HF Damping 21
High - Button 86
High Pass Filter 10, 86

I

IEC Mains Connector 3
Incoming control change 54
Incoming program change" 54
Inertia 109

Input 52, 53, 95, 96
Input Section 2
Input signal through the Filter and effects. 96
Input/sw 1 3, 52, 67
Input/sw 2 3, 53
inputs section 95
Inputs to be routed to the effects. 96
Inserting a Favourite 29

K

Kbd arp transpose zone detune 64
Kbd transpose zone highest note 64
Kbd transpose zone lowest note 64
Key Sync 7
keypad 33, 34, 38, 39, 43, 55, 59
keypad section 2, 59
Knob mode 53

L

Latch 63, 67, 124
Latch - Button 67
Latch type 63
Layer 25
Layered 26
Legato 68, 74
level 95
Level - Knob 77, 79, 80, 82
Level/Balance - Knob 105
LFO 1 69, 77, 78, 79, 81, 82, 89, 93
LFO 1 - Button 77, 78, 79, 81, 82, 89, 93
LFO 2 77, 79, 81, 82, 85, 89, 90, 93
LFO 2 - Button 77, 78, 79, 81, 82, 89, 90, 93
LFO Delay 92, 93
LFO Section 2, 91
LFO waveshape 109
LFOs 68, 97
Linear 73
Local Control 51
Low - Button 86
Low Pass Filter 10, 86

M

Master Keyboard Functions 127
Master Left and Right 3
Master tune 48
master vol section 46
Master Volume Section 2
Memory protect 52
Menu - Button 61, 69, 84, 91, 95, 98
Menu - Button & Chorus - Button 108
Menu - Button & Config - Button 113
Menu - Button & Delay - Button 105
Menu - Button & Distort/EQ - Button 113
Menu - Button & Reverb - Button 107
MIDI 41, 48, 49, 50, 54, 55, 56, 123, 124, 127, 128
MIDI - Button 123
MIDI channel 48, 124, 129
MIDI clock 50, 65, 68, 92
MIDI Controller / NRPN tables 138
MIDI feedback loop 52
MIDI IN / MIDIOUT /

MIDITHRUConnectors 3
Mix - Button 77
Mod Depth 20, 108, 109
Mod Depth - Knob 77, 78, 79, 80, 81, 82, 83
Mod Wheel 69, 79, 80, 81, 83, 89, 90, 92, 98, 107, 108, 110, 111, 114, 129, 130
Mode Section 2, 47
modulation 77, 78, 79, 80, 81, 82, 83, 89
Modulation Matrix 14
Monophonic 35, 65, 126
Monophonic Preset Patterns 150
Multi trigger 103
Multi Trigger - Button (ENV 1) 103
Multi Trigger - Button (ENV 2/3) 103
Multitimbral 26, 31, 42
Multitimbral use 31
Mute 42, 66, 124
Mute - Button 66
MWheel LFO1 amt 69
MWheel speed mod 92

N

name 38, 39, 43, 60
No of Steps 57
noise 6
Noise - Button 71
Noise - FM - Button 71
Note 35, 36, 57
NOVATION JARGON 22

O

octave 68, 71, 72
Octave - Buttons 46
Octave/Semi Knob 72
Omni 124
On - Button 67
Operating System 133
Osc mode 73
Osc start phase 75
Osc1 - Button 71
Osc2 - Button 71
Osc3 - Button 71
Oscillator 22
Oscillator Modulation Matrix 14, 76
Oscillator Modulation Matrix Section 2
Oscillator Section 2, 69
Oscillator sync 6
OSCILLATORS 6
Oscs filt bypass 86
Output 41
Output level 113
Output ranging 66
Outputs 122
Overdrive 86, 88
Overdrive - Knob 88
Overdrive curve 86
Overload 104
Overload / Poly Limit - Button 104
overvoicing 104

P

Packet error 55
Page - Buttons 58
Pan 21, 119

- Pan - Button 105
 Pan Depth 21
 Pan Speed 21
 Pan Type 21
 Part 22, 25, 31, 41, 42, 121, 126
 Part 1 - Button 121
 Part 2 - Button 121
 Part 3 - Button 121
 Part 4 - Button 121
 Part 5 - Button 121
 Part 6 - Button 121
 Part detune 121
 Part Edit Section 2, 121
 Part Effect 44
 Part effects 119
 Part Effects Buffer 119
 Part External - Button 127
 Part highest note 126
 Part lowest note 126
 Part outputs 122
 Part polyphony 126
 Part semitone 121
 Pass to effects 96
 Pattern 28, 35, 56, 57, 62, 65
 Pattern Bank 35, 62
 Pattern no. 62
 patterns 66
 PBMWAVS 129
 Pedal 50, 53, 124, 125
 Pedal / Switch 3 Socket 3
 Pedal/breath 124
 Pedal/breath control 50
 Pedal/sw 3 53
 Percussive 73, 75
 Performance 22, 23, 25, 31, 33, 41, 52, 59, 66, 121, 126
 Performance Bank A 148
 Performance Bank B 149
 Phaser 20, 108, 109, 110, 111
 Pickup 53
 pitch 6, 78, 79
 Pitch - Button 78, 79
 Pitch - Button 78
 Pitch Bend 70, 129
 Pitch bend range 70
 Poly mode 73
 Polyphonic 35, 36, 66, 126
 Polyphonic Preset Patterns 151
 Polyphony 41, 74, 126
 Polyphony - Button 125
 Porta mode 73
 Porta type 73
 Portamento 36, 73, 74, 75
 Portamento - Knob 75
 Power On/Off - Switch 3
 PPM meters 95
 Pre Effects level 113
 Preglide 74
 Prog change 55
 Prog change TX 54
 Prog Level - Knob (ENV 1) 104
 Program 22, 23, 24, 33, 34, 35, 52, 59, 126
 Program Bank A 140
 Program Bank B 141
 Program Bank C 142
 Program Bank D 143
 Program change filter 125
 Program change message 54, 55, 125, 129, 130
 Pulse wave 6
 Pulse Width 79
 Pulse Width Modulation 6
 PWM 6
Q
 Q norm amount 84
 Quad Chorus 20
 Quantise 63
R
 Random 94
 Range 41
 Range - Button 126
 Real time trans 63
 Real-time Transpose channel 61
 real-time transpose zone 51, 63, 64
 Release 99
 Release - Slider (All Envelopes) 104
 Release time 12
 Res AT amt 85
 Res AT LFO2 amt 85
 Res MWh LFO2 amt 85
 Resolution 35
 Resonance 10, 84, 85, 87, 89, 90
 Resonance - Knob 87
 Resonance/Width - Knob 90
 Rest 57
 Restore from ROM 52
 Reverb 107, 108, 111, 119
 Reverb - Button 105
 Reverb whee 108
 Ring Modulation 9, 71
 Ring modulator 10
 Rotary Speaker 19, 108, 109, 110, 111
S
 S/H - Button 94
 Sample and Hold 94
 Saw - Button 94
 Saw Waveform - Button 72
 Sawtooth 6, 72, 94
 selecting drum maps and drum map programs 34
 selecting programs, performances & Favourites 33
 Selects 56
 semitone 72
 sensitivity 95
 Sensitivity/Input level of the Inputs 95
 SETTING UP 4
 Solo 42, 71
 Solo - Button 71
 song select message 131
 Sound 6
 Source 76
 SPDIF Phono In and Out Connectors 3
 Special 119
 Special filter 87
 Special type filter width 86
 Special Waveform - Button 72
 Specification 136
 Speed 26, 31, 35, 37, 68, 93, 108
 Speed - Knob 68, 93
 Speed 2 109
 Split 25, 26
 Sq waveform - Button 72
 Square 6, 72, 94
 Square - Button 94
 Staccato 68
 step 35, 57
 Step Note Vel. Gate 57
 Stereo width 106, 110
 Sustain 100, 101, 102, 103, 129
 Sustain - Slider (All Envelopes) 104
 Sustain level 12
 Sustain pedal 67, 123
 Sustain Time 13
 Sustain/sw2 input 123
 sw 1 52, 124
 sw 2 53
 sw 3 53, 124
 Sync 7, 35, 65, 80, 81, 92, 106
 Sync - Button 81
 Sync - Button 80
 Sync Effect 22
 Sync key follow 70
 Sync Skew 7, 8, 10, 70
 Sysex Reception 49
 Sysex transmission 49, 123
 Sysex TX delay 55
T
 TB303 74
 Temp display time 55
 Tie 57
 time signature 65
 tracking 99
 transpose 51, 63, 121, 128
 Transpose Zone 51, 61
 Transpose zone- Button 61
 Tri - Button 94
 Triangle 94
 Triggering 103
 Troubleshooting 132
 Tune 40, 41, 71
 Tune - Button 121
 Type 107
U
 U/D 1 - Button 67
 U/D 2 - Button 67
 Unison 74
 Unison Detune 74, 75
 Unison mode 74, 75
 Up - Button 67
 update 44
 Upgrading 133
 User 35
 User Pattern 57
V

INDEX

VCO 75

VCO drift 75

Vel sensing 53

Velocity 36, 41, 57, 63, 98, 101, 102,
128

velocity curve 53

Vocoder 105, 119

Vocoder - Button 105

Voice 22

volume 11, 46, 77, 129, 130

Volume - Knob 46

W

waveform 72

Wheel - Button 77, 79, 80, 81, 83, 89,
90

Wheel level 110

Wheel mode 110

Width 87, 89, 90

Width - Button 79

Width - Button 80

Write 28, 29, 30, 38, 43, 48, 52, 56, 57,
60



The lightning flash with arrowhead symbol within an equilateral triangle, is intended to alert the user to the presence of uninsulated "dangerous voltage" within the product's enclosure that may be of sufficient magnitude to constitute a risk of electric shock to persons.

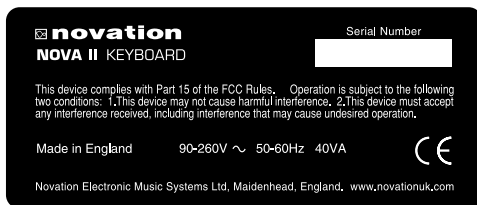

The Exclamation point within an equilateral triangle, is intended to alert the user to the presence of important operating and maintenance (servicing) instructions in the literature accompanying this product.

INSTRUCTIONS PERTAINING TO A RISK OF FIRE, ELECTRIC SHOCK, OR INJURY TO PERSONS.

IMPORTANT SAFETY INSTRUCTIONS SAVE THESE INSTRUCTIONS

WARNING - When using electric products, basic precautions should always be followed, including the following:

- 1 Read all the instructions before using the product.
- 2 Do not use this product near water . For example, near a bathtub, washbowl, kitchen sink, in a wet basement or near a swimming pool, or the like.
- 3 This product should only be used with a cart or stand that is recommended by the manufacturer.
- 4 This product, either alone or in combination with an amplifier and speakers or headphones, may be capable of producing sound levels that could cause permanent hearing loss. Do not operate for a long period of time a high volume level or at a level that is uncomfortable. If you experience any hearing loss or ringing in the ears, you should consult an audiologist.
- 5 this product should be located so that its location or position does not interfere with its proper ventilation.
- 6 The product should be located away from heat sources such as radiators, heat registers, or other products that produce heat.
- 7 The product should be connected to a power supply only of the type described in the operating instructions or as marked on the product.
- 8 The power supply cord of the product should be unplugged from the outlet when left unused for a long period of time.
- 9 Care should be taken so that objects do not fall and liquids are not spilled into the enclosure through openings.
- 10 The product should be serviced by qualified service personnel when:
 - A The power supply cord or the plug has been damaged.
 - B Object s have fallen onto, or liquid has been spilled into the product.
 - C The product has been exposed to rain.
 - D The product does not appear to operate normally.
 - E The product has been dropped, or the enclosure damaged.
- 11 Do not attempt to service the product beyond that described in the user - maintenance instructions. All other servicing should be referred to qualified service personnel.

GROUNDING INSTRUCTIONS

This product must be grounded. If it should malfunction or break down, grounding provides a path of least resistance for electric current to reduce the risk of electric shock.

This product is equipped with a cord having an equipment grounding conductor and a grounding plug. The plug must be plugged into an appropriate outlet that is properly installed and grounded in accordance with all local codes and ordinances.

DANGER:

Improper connection of the equipment grounding conductor can result in a risk of electric shock. Check with a qualified electrician or servicemen if you are in any doubt as to whether the product is properly grounded. Do not modify the plug provided with is product - if it will not fit the outlet, have a proper plug installed by a qualified electrician.

FCC Information (U.S.A.)

1. IMPORTANT NOTICE: DO NOT MODIFY THIS UNIT! This product, when installed as indicated in the instructions contained in this Manual, meets FCC requirements. Modifications not expressly approved by Novation may void your authority, granted by the FCC, to use the product.
2. IMPORTANT: When connecting this product to accessories and/or another product use only high quality shielded cables. Cable/s supplied with this product MUST be used. Follow all installation instructions. Failure to follow instructions could void your FCC authorisation to use this product in the USA.
- 3 NOTE: This product has been tested and found to comply with the requirements listed in FCC Regulations, Part 15 for Class "B" digital devices. Compliance with these requirements provides a reasonable level of assurance that your use of this product in residential environment will not result in harmful interference with other electronic devices. This equipment generates/uses radio frequencies and, if not installed and used according to the instructions found in the users manual, may cause interference harmful to the operation of other electronic devices. Compliance with FCC regulations does not guarantee that interference will not occur in all installations. If this product is found to be the source of interference, which can be determined by turning the unit "OFF" and "ON", please try to eliminate the problem by using one of the following measures:

Relocate either this product or the device that is being affected by the interference.
Utilise power outlets that are on different branch (Circuit breaker or fuse) circuits or install AC line filter/s.
In the case of radio or TV interference, relocate/re orient the antenna. If the antenna lead-in is 300 ohm ribbon lead, change the lead-in to co-axial type cable.
If these corrective measures do not produce satisfactory results, please contact the local retailer authorised to distribute this type of product.

The statements above apply ONLY to products distributed in the USA.

CANADA

The digital section of this apparatus does not exceed the "Class B" limits for radio noise emissions from digital apparatus set out in the radio interference regulation of the Canadian Department of Communications.

Le present appareil numerique n'emet pas de bruits radioelectriques depassant les limites applicables aux appareils numeriques de la "Classe B" prescrites dans le reglement sur le brouillage radioelectrique edicte par le Ministere Des Communications du Canada.

This only applies to products distributed in Canada.
Ceci ne s'applique qu'aux produits distribues dans Canada.



CE mark for European Harmonised Standards

CE mark which is attached to our company's products of AC mains operated apparatus until December 31, 1996 means it conforms to EMC Directive (89/336/EEC) and CE mark Directive (93/68/EEC).

And, CE mark which is attached after January 1, 1997 means it conforms to EMC Directive (89/336/EEC), CE mark Directive (93/68/EEC) and Low Voltage Directive (73/23/EEC).

Also, CE mark which is attached to our company's products of Battery operated apparatus means it conforms to EMC Directive (89/336/EEC) and CE mark Directive (93/68/EEC).

Trademarks

All trademarks or registered trademarks used in this manual are the property of their respective holders.

Specifications subject to change:

The information contained in this manual is believed to be correct at the time of going to press. However, Novation reserves the right to change or modify the specification without notice or obligation to update existing units. While every effort is made to make sure no errors are present in this document, Novation cannot accept responsibility or liability for loss of data, incorrect operation or misleading operation due to errors.

For More Information Contact:

 **novation**

A4 Westacott Business Centre, Maidenhead Office Park,
Maidenhead, Berkshire, England. SL6 3RT.

Ph: +44 (0) 1628 828888 Fax: +44 (0) 1628 825599

E-Mail: sales@novationuk.com Web Site: <http://www.novationuk.com>